

moorpark college catalog

1974-1975

(revised edition)

Moorpark College
7075 Campus Road
Moorpark, California 93021
Phone: Area Code (805) 529-2321

EIGHTH ACADEMIC YEAR

MEMBER OF

The American Association of Junior Colleges
The California Junior College Association
The Western Association of Schools and Colleges

ACCREDITED BY

The Western Association of Schools and Colleges
The California State Department of Education

MAILING ADDRESS

Moorpark College
7075 Campus Road
Moorpark, CA 93021
Telephone (805) 529-2321

BOARD OF TRUSTEES

Phillip C. McConnell, President
Dr. William Simpson, Vice-President
Mrs. Monroe Everett
Robert A. Addison
Celso Ovalle

ADMINISTRATION

Dr. Ray E. Loehr, Superintendent
Moorpark College President to be named
Dean of Instruction to be named
James R. Gayle, Associate Dean of Instruction
Lawrence G. Lloyd, Associate Dean of Instruction,
Vocational Education and Educational Development
Dr. Howard Siegel, Associate Dean of Instruction,
Extended Day, Community Campus,
Summer and Evening Programs
Dr. W. Ray Hearon, Dean of Students
Lewis R. Camillucci, Associate Dean of Students,
Counseling
James Moore, Jr., Associate Dean of Students,
Admission and Records
Maynard E. Sommer, Administrative Assistant
Gerald R. Fecht, Director, Student Activities
Dr. Michael M. Slama, Director, Library Services
Marjorie Imbach, Coordinator, Community Services
Floyd D. Thionnet, Coordinator, Student Financial
Support Services

DIVISION CHAIRMEN

Dr. Kenneth E. Ainge, Chairman, Division of Technology;
Director, Evening Program
W. Roger Boedecker, Chairman, Division of Social Science
Paul Dunham, Chairman, Division of Health Education,
Physical Education
Michael K. Seely, Chairman, Division of Humanities
Kokki Shindo, Chairman, Division of Natural Sciences
and Mathematics

DEPARTMENT HEADS/COORDINATORS

Kirk Aiken, Department Head, Art
Donald C. Bowen, Department Head, Business and Economics
John W. Hanft, Department Head, Language and Literature
Alan Hyams, Department Head, Performing Arts
Robert Herman, Department Head, History and Institutions
Charles D. Molnar, Department Head, Mathematics
Dr. Darlene Pacheco, Department Head, Behavioral Science
Jack Reynolds, Department Head, Life Sciences
David Wagner, Department Head, Physical Sciences
Jack Fleming, Coordinator, Administration of Justice

COMMUNITY CAMPUS DIRECTORS

Sharon Biderman, Conejo Community
Maxine Tallman, Camarillo Community
Floyd Martin, Simi Valley Community

TABLE OF CONTENTS

The College - 2
Programs and Courses - 33
Faculty - 226
Index - 232

the philosophy

The Ventura County Community College District is dedicated to meeting the needs of the residents of the District for education beyond the high school level. The education provided is to help each student realize his greatest potential by cultivating his cultural and vocational abilities, by preparing him to assume the responsibilities of citizenship in a free society, and by utilizing his resources to achieve a richer and more productive life.

The guiding philosophy of Moorpark College is based on an enduring belief that each man wants to realize his own potential; and that, armed with this powerful motivating force, he has the capacity to learn, and thus, to direct his own destiny. To make progress toward this major objective, it is required that each member of the college community:

Have access to information about his natural environment, and himself, about society, and about his heritage.

Be provided an opportunity to gain understanding of important issues, concepts, and relationships.

Enjoy freedom to inquire, to explore, to take issue, and to choose.

Develop a level of competency that gives him a chance to become self-sustaining and discerning.

history

On July 1, 1962, the Ventura County Community College District became a legal entity charged with the operation of a program of public community college education in Ventura County.

The people of Ventura County are served by two colleges, Moorpark and Ventura. Ventura College has been in operation since 1925, first as a part of the Ventura Union High School District, later, as a

separate institution. Moorpark College was established by Board action on March 19, 1963, to serve primarily the rapidly growing communities of eastern Ventura County. The 134-acre hillside site for Moorpark College, located between Simi and Moorpark in eastern Ventura County, was selected early in 1963. Later that year the Moorpark College Advisory Committee was appointed by the Board and charged with making recommendations regarding finance, architecture, curriculum, and service. In April, 1964, this Committee reported to the Board, and plans were put into effect to bring the college into existence. In 1965, the master plan for developing the college was approved by the Board. This plan called for the construction of facilities in two phases, with the first phase completed in the fall of 1967 to accommodate 2,000 students. Eventual completion of the second phase will bring the plant capacity to 5,000 day students.

On July 1, 1966, the Board of Trustees appointed Dr. John J. Collins as Moorpark College's first president. During 1966-67, Dr. Collins and his staff completed the plans for staffing, curriculum, student services, and plant occupancy. Moorpark College opened its doors to students for the first time September 11, 1967. Over 2,500 day and evening students attended classes at the college during its first semester. The college held its first open house December 3, 1967 with over 3,000 persons in attendance.

Moorpark College was officially dedicated and Dr. John J. Collins inaugurated as first President at colorful ceremonies May 3, 1968. The Honorable Houston Fluornoy, Controller of the State of California, was the principal speaker.

In May, 1968, the college received its first formal accreditation visit and was recommended for full accreditation by the Western Association of Schools and Colleges. Course offerings and programs have expanded with each succeeding semester. In its fourth year of operation, the college added a new Applied Arts building which provides facilities for Law Enforcement, Home Economics, operation of a Nursery School and Graphic Arts. The building features a special forum which can be used for large class instruction, lectures, films, and dramatic presentations. Our latest addition is a building to house the Theatre Arts program, an art studio, general purpose classrooms and offices.

The college, has grown from less than 1200 day students in its first semester to over 4500 day students anticipated for the fall semester, 1973. An additional 4000 attend the college in the evening. In the last two years the college has developed an extensive off-campus program, offering a number of classes in the nearby communities which are in the college's drawing area.





specific objectives

A. CURRICULUM

Consistent with the philosophy of providing educational opportunities, access to information, and the development of competencies, Moorpark College offers the following educational programs designed to meet the needs of those who choose to enroll.

1. General Education

Recognizing that man is more than a mere unit of production, and that students must learn to live as well as earn a living, Moorpark College emphasizes the values of general education. To this end, then, it is essential that a student develop a command of the written and spoken language; understand mathematics; have knowledge of the structure and function of the human body; develop an understanding of the history and political institutions of the United States; learn to appreciate beauty, form, and color; perceive his own roles and understand the society in which he lives, and become familiar with the elements of the scientific method.

2. Preparation for Transfer

Moorpark College provides programs and courses that satisfy the lower division requirements at four-year colleges and universities in general education and in a wide variety of pre-professional fields. Special care is exercised to see that these courses and programs are parallel with those offered at senior colleges, and that they do, in fact, transfer with full credit. Articulation with senior colleges is a joint responsibility of faculty and administration.

3. Vocational-Technical Education

Preparation for employment is an important and legitimate function of higher education. Moorpark College recognizes the changing nature of



industrial society and, therefore, is committed to specific preparation, as well as broad-gauge vocational-technical training that prepares for tomorrow as well as today. Vocational-technical programs are designed to provide entry-level skills, technical skills, technical knowledge that will permit employment mobility as changes occur, and general education that is the footing upon which specialized training is erected.

4. Developmental Programs

Moorpark College seeks to meet the needs of those who choose to enroll, but who are not fully prepared for the demands of college level instructional programs. Since the learning process takes place via the use of words and numbers, all students must develop command of the written and spoken language, as well as a degree of mastery of mathematical processes. Those who lack these skills will not find equal opportunity in the college classroom. Those students are, therefore, offered a well-programmed chance to improve, including developmental reading, vocabulary building, oral communication, basic mathematics, and logic.

B. CO-CURRICULUM

Moorpark College recognizes that students have many needs beyond those served by the formal curriculum. Students are viewed as full participants in the development of programs leading to effective self-government, cultural enrichment, intellectual stimulation, and social growth. These programs should reflect the purposes of the college and the diversity of student interests and needs. Students do not merely experience the climate of the campus; they help create it, and in doing so, exercise their privileges and responsibilities as citizens.

C. GUIDANCE - ACADEMIC

To help implement the philosophy of the "open door policy," guidance services are provided to assist students in assessing their own capabilities, interests, and goals. Moorpark College is strongly committed to a policy of engaging students, counselors, faculty members, community resources, and necessary specialists in the very important task of helping students develop personal and vocational goals and values.

D. GUIDANCE - CAREER DEVELOPMENT

The Moorpark College Counseling and Guidance Department has a fully equipped Career Development Center located at the Campus Center. The student will find information on various careers on file at the Center. There is a counselor available at all times to discuss particular career concerns and problems. No appointment is necessary. The student will also find a receptionist to help him locate the material that he is looking for.

E. GUIDANCE - DROP-IN CENTER

Students who have a personal concern or problem may want to visit the Drop-In Center. Counselors are available at all times to help students with their personal problems on a walk-in no-appointment basis. Concerns and problems are held in the strictest confidence. The Center is located in the library building, room 215.

admissions eligibility

residency requirements

Moorpark College admits any high school graduate or person 18 years of age or older who is capable of profiting from the instruction offered. Special students disqualified from other institutions must petition, through the Assistant Dean of Students/Admissions and Records Office, for admission.

The California state law effective May 1, 1973, regarding student residency requirements, indicates the following:

- A. Each person enrolled in or applying for admission to a California community college is, for purposes of admission and/or tuition, classified as a "district resident," a "non-district resident" or a "non-resident."
- B. If a student is classified as a district resident or a non-district resident, the student shall be admitted to the college without non-resident tuition. Students classified as non-residents will



be required to pay a tuition fee fixed each year by the California State Legislature. The fee has been established for the 1973-74 school year at \$27.00 per unit, for a maximum fee per semester of \$405.00 for 15 or more units. This fee must be paid prior to enrollment in the college.

- C. A "district resident" is a person who, after attaining his eighteenth birthday, has resided within California for at least one year prior to the first day of instruction, and is a Ventura County resident at the time of enrollment.
- D. A "non-district resident" is a student who has lived in California for more than one year, but whose residence is in a territory that is not in a community college district.
- E. A "non-resident student" is one who does not have residence in the state for more than one year prior to the resident determination date.

For the purpose of determining residence status, a residence determination date is established for each term or semester by the District Board of Trustees. For 1973-74 the residence determination dates are as follows:

First summer session -- June 18, 1973
Fall Semester -- September 17, 1973
Spring Semester -- February 4, 1974

Because of the complexity in the interpretation of these laws, students having difficulty in determining their residency should contact the Records Office residence clerks, phone 529-2321, extension 255.

interdistrict permits

Interdistrict attendance agreements and notices of restriction for the fiscal year 1973-74 which are in effect as of April 1, 1973 (the purpose of this notice is to meet the requirement of Education Code Section 25505.5).

Students whose legal residence is in the Ventura County Community College District must apply for a permit to attend any of the community college districts listed below.

Students with legal residence in the community college districts listed below must present permits for attendance in the Ventura County Community College District from the district in which they reside.

Antelope Valley Joint Community College District
Butte Community College District
Cabrillo Community College District
Cerritos Junior College District
Compton Junior College District
Foothill Community College District
Fremont-Newark Community College District
Glendale Community College District
Los Angeles Community College District
Marin Junior College District
Merced Community College District
Monterey Peninsula Community College District
Mt. San Jacinto Junior College District
Redwoods Joint Community College District
Riverside Community College District
Saddleback Community College District
San Joaquin Delta Community College District
San Jose Community College District
San Mateo Junior College District
Santa Barbara Junior College District
Santa Clarita Community College District
Shasta-Tehama-Trinity Joint Junior College District
Siskiyou Joint Community College District
West Hills Junior College District
West Kern Junior College District
Yuba Community College District

foreign students

Foreign students are admitted under a quota system, and must have permission to register from the Assistant Dean of Students/Admissions and Records Office.

Those students granted permission to attend, under the quota system, must adhere to the following procedure.

- A. Submit a completed application for admission.
- B. Provide evidence of proficiency in the use of the English language. Students are required to complete the Test of English as a Foreign Language (TOEFL) and achieve a score of at least 505. For information, they should write:

Educational Testing Service
Box 899
Princeton, N.J. 08540
- C. State a specific objective.
- D. Submit a letter of recommendation and transcripts from preparatory schools and colleges previously attended.

- E. Submit a confidential statement of finance.
- F. Submit a health statement from an American physician. This statement must include a TB X-ray result.
- G. Immigration Department Form I-20A will be issued only after all other prerequisites for admission have been met.
- H. Payment of tuition fee prior to enrollment (for the 1973-74 school year, tuition has been established at \$27.00 per unit, with a maximum of \$405.00 per semester, for 15 or more units).

Moorpark College attempts to select for admission only those foreign students who are above average in scholastic achievement and personal qualifications.

advanced placement

High school students planning to enroll in college courses must secure prior approval from their high school principal, and shall be required to file an approved advanced placement form before being permitted to register.

admissions procedure

1. APPLICATION FOR ADMISSION--An application may be obtained by either writing to the Records Office, Moorpark College, 7075 Campus Road, Moorpark, CA 93021, or telephoning (805) 529-2321, extension 251. This form should be completed and returned at the earliest possible date.
2. STUDENT IDENTIFICATION NUMBER--Moorpark College uses social security numbers as permanent identification numbers for all students. Students should be prepared to present their social security card at the time of enrollment for verification purposes. All students will be issued an identification card. Students are to retain this card as long as they remain in attendance at Moorpark College.

3. TRANSCRIPTS--Request the high school last attended to forward an official transcript of all work completed to the Registrar, Moorpark College. Students who have previously attended college must request that all colleges attended forward official transcripts to the Registrar, Moorpark College.

Students transferring to Moorpark College from other colleges or universities are required to declare all previous college work evidenced by official transcript. Failure to provide complete information may result in dismissal from Moorpark College. Students transferring from accredited colleges will normally be granted credit for lower division courses which correspond to courses described in this catalog.

4. PLACEMENT--Placement of student in classes is based on high school transcript and the desire of the student. No placement test is required. At the discretion of the institution, tests may be required for placement in courses.
5. COUNSELING INTERVIEW--Each student will have the assistance of a counselor in planning his program of study. Preliminary thought should be given to the selection of a major and courses to gain the full benefit of the counseling conference. In planning a program, the student should consider abilities, skills, and personal qualities needed in selected vocational fields. Students who intend to transfer to another college at some future date should become aware of the requirements for transfer.

The normal program of study is 15½ to 17½ units. Thus, the average student will complete the requirements for the Associate in Arts degree within four semesters. First-semester freshmen are encouraged to limit themselves to a normal program.

Students who wish to take more than 18 units need special permission from the Dean of Counseling, the Dean of Admissions, or the Dean of Students.

6. REGISTRATION--Students may register immediately after counseling interviews. Student body identification card and fee receipt (available from the Bookstore) are required before registration.
7. POLIO AND MEASLES IMMUNIZATION--Students under 18 years of age, enrolling at Moorpark College for the first time, and who have not attended a California school must show evidence of immunization for measles and polio at the time of registration.

8. VALIDATION--Students who have completed their registration process must validate their registration by securing their schedule of classes.
9. LATE REGISTRATION--Late registration severely handicaps the student in achieving college success and should be avoided whenever possible.

Ordinarily, a student may not register at Moorpark College after the second week of the semester. Exceptions will require approval of the Dean of Admissions and Records.

Adding a class is an official transaction which can only occur if the student is registered. Students may add classes to their schedules through the third week of the semester. The instructor's written permission is required for each class added. Instructor's permission and regular attendance do not constitute registration.

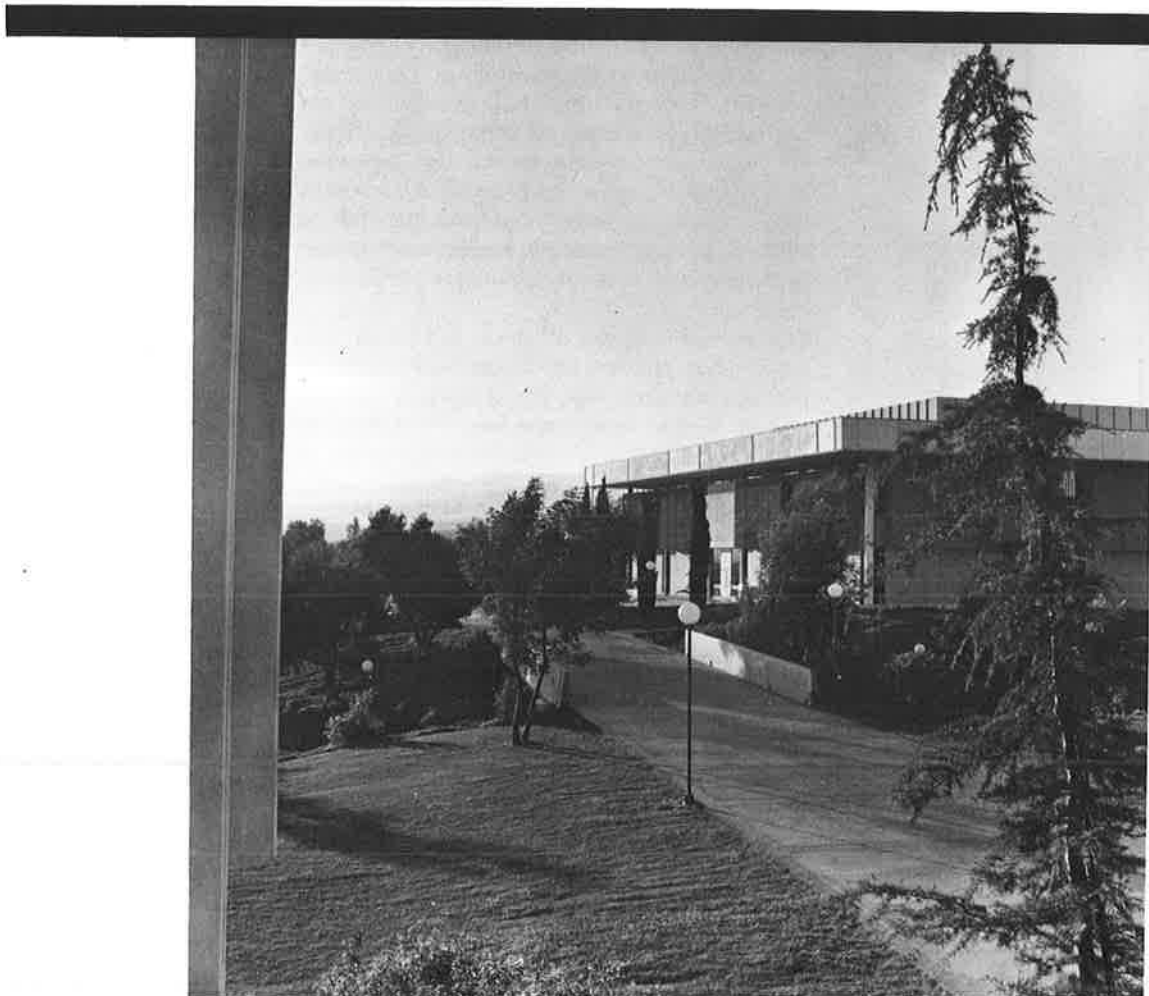

expenses

Expenses will vary from year to year and fee schedules are subject to change. Student expenses for the 1973-74 school year are listed for your information:

TUITION

Tuition is required of non-resident students only (out-of-state or out-of-country). The 1973-74 fee schedule has been established at \$27.00 per unit with a maximum of \$405.00 for 15 or more units per semester.

HEALTH FEE

The Ventura County Community College District Board of Trustees has established a required health fee for all students enrolling in the college. The schedule for the 1973-74 school year is as follows:

Fall Semester Day Students: \$3.75
Fall Semester Evening Students: \$2.00
Summer School Day and Evening Students:
\$1.00

PARKING FEE

The Board of Trustees of the Ventura County Community College District has established a parking fee for those students who wish to park a vehicle on campus. The fee schedule for the 1973-74 school year is as follows:

Semester On-campus Day Students
4-wheel vehicles: \$6.25
motorcycles & motor scooters: \$4.00

Semester On-campus Evening Students: \$3.00

Summer Session
4-wheel vehicles: \$4.00
motorcycles & motor scooters: \$2.00

The day parking permit allows students to park during both the day and evening hours. An evening parking permit is valid ONLY for evening hours. There will be a coin-operated lot for students who do not regularly bring a car but may occasionally do so. Parking permits may be purchased at the Bookstore. Traffic citations will be issued to students parking on campus without a valid permit.

TEXTBOOKS

The average cost for textbooks and supplies ranges from \$50.00 to \$75.00 per semester; they may be purchased at the College Bookstore located in the Campus Center.

TRANSCRIPTS

Students are permitted three requests for Moorpark College transcripts without charge. Additional requests are \$1.00 each.



financial aid

Students who need funds for continuance of their education should apply for financial aid through their counselor or the Financial Aid Officer. To extend financial aid to the largest number of students, Moorpark College attempts to develop financial aid packages which combine grants, loans, scholarships, and work-study. Students should be aware of deadline dates for applying for financial aid. These dates change from year to year, but information can be obtained by calling or visiting the Financial Aids Office.



grants*

The grant programs for students of Moorpark College are funded by Federal and State governments. These programs are not loans and do not require repayment. Students with financial need who attend Moorpark College may be eligible. In order to remain eligible, a student must maintain a full-time status, 12 units, and satisfactory grades.

loans*

Students with financial need may qualify for loans either through Moorpark College and the regular financial aid package or through a bank or savings and loan. Both of these loans bear simple interest on the unpaid balance. Interest is not charged, nor repayment required until nine months from the date the borrower ceases to be a full or half-time student. Repayment of such a loan is scheduled over a 10-year period.



work study program (cwsp)*

A limited number of qualified students may obtain employment through the work-study program. Awarding is based on need as a portion of the financial aid package. Students are limited to 15 hours per week while classes are in session; but at other times may work up to 40 hours per week. Employment is available on or off campus.

scholarships

All scholarship awards are made on a competitive basis; consideration is given to scholastic achievement, financial need, and academic promise. Eligibility for a scholarship is determined from the applicant's statement, official transcripts, and letters of recommendation. As scholarships become available for Moorpark College students, announcements will be made in the COUNSELOR'S CORNER in the school newspaper. All scholarships are processed through the office of Mrs. Suzanne Colangelo in the Campus Center.

eop supportive services*

The purpose of EOP Services is to furnish students with the necessary support so that they may succeed in furthering their educational goals here at Moorpark College. The following services are available:

1. Academic Counseling - To help the student in class scheduling, adding classes and withdrawing procedures, academic and financial disqualification problems, financial aid qualifications concerning other educational institutions, as well as personal matters that may confront you.
2. Health Services - Free complete physicals, assistance with medical (pregnancies and birth control), and dental problems, visual and hearing problems. Services are available to all E.O.P. students.
3. Bookstore Loans and Grants - Small, short-term loans and grants are available to E.O.P. recipients as well as Moorpark College students who qualify to buy books and supplies needed for the academic semester.
4. Transportation - Information leading to the information of car pools will be available at the E.O.P. office.
5. Tutoring - The tutorial program provides academic assistance in all areas of study. Tutors, generally sophomores and graduates with previous experience and a strong academic background, are hired by E.O.P. to provide this academic assistance. Upon request, tutoring is done on an individual basis according to the needs of the student.
6. Housing and Job Placements - Housing and employment can be a problem to the student. E.O.P. helps to alleviate this problem by acquiring employment opportunities on and off campus. Housing information will also be provided. This assistance is in addition to what is provided by the college.

We hope that you will work with us. We are here to help you with any problem that may confront you.



For further information contact:
E.O.P. Office
Moorpark College
7075 Campus Road
Moorpark, CA 93021
(805) 529-2321, Ext. 285

*All of these programs are subject to change as determined by Federal and State Governments. Any questions should be referred directly to the Financial Aid Office.

employment services

Students seeking part-time or permanent employment should apply at the Placement Office located in the Applied Arts Building. In the area of part-time employment, special emphasis is placed on locating work for which the student has been trained in order to relate his work experience to his vocational objectives. The placement service is available to current students, former students, and graduates.

Referrals for placement are made on the basis of qualities demonstrated by the student during his college attendance. Since employers rely upon the college to furnish them with information helpful in evaluating applicants, the office works in close cooperation with department heads and instructors. Application should be made in person at the Placement Office. Announcements of job opportunities are posted in the Campus Center and the Applied Arts Building.



student services and procedures

COUNSELING AND GUIDANCE

A variety of counseling services is provided at Moorpark College to assist students during their college career. Counselors are available to aid each student in making his own important decision by helping him examine his abilities, attitudes and values, and evaluate his goals and make his own decisions concerning educational and career directions.

Specific Counseling services include personal counseling, group counseling, career development, academic guidance, and information regarding graduation requirements and requirements for transfer to the state college and universities.

ACADEMIC GUIDANCE

Selection of classes and the planning of academic programs is primarily the student's responsibility. The counselor's role is that of a "resource person." A student is assigned a counselor and can drop in to see him at any time for a quick question or make an appointment for a longer session. The Counselor's office schedule is posted on his door. Feel free to consult him at any time. Pamphlets and booklets are also available to aid the student with his academic planning.

PERSONAL COUNSELING

The Counseling and Guidance Department realizes that students at sometime or other have problems and concerns that interfere with learning. The Drop-In Center located in L-215 (upstairs in the Library Building) is designed to help student with these concerns. It allows an opportunity to discuss the problem or concern with a professional counselor in an informal and confidential atmosphere. A counselor is available Monday through Friday. Students should feel free to come in and consult with a counselor.

RAP SESSIONS

There is also an opportunity for students to join a RAP group which is designed to discuss problems and concerns in a group setting, usually with students who have similar concerns and problems. This very effective method of problem solving is done in an informal and confidential atmosphere. The groups are primarily unstructured and facilitated by a professional counselor. See the Personal Growth Section of the catalog for the descriptions of the many rap sessions available.

CAREER RESOURCE CENTER AND CAREER DEVELOPMENT

Many students are in the process of searching for career choice. The Counseling and Guidance Department operates a full service facility with such unique features as an up-to-date library of career information, a variety of audio visual aids designed for career exploration, informative speaker programs, timely films, and most important career development counselors available five days a week to aid students in the process of career development.

Career planning classes are also available which are designed to help students become aware of themselves and to become aware of the many careers available to them. The class is specifically designed to develop within the student a philosophy and procedure of selecting a career, to become aware of oneself, aware of careers and how the two factors are related. See the Personal Growth Section of this catalog for details regarding the career development class.



HEALTH SERVICES

Health services are available at the Health Center, which is located in the Administration Building, A-115. The college nurse is on duty daily to confer with students regarding health and illness problems. A doctor's services are available at specified hours with an appointment. Doctor's hours are posted in the Health Center. A nurse will be on duty during the evening hours for evening students.

The following services are available free, or for a nominal fee, in the Health Center:

- | | |
|---|---|
| Allergy medication given with doctor's order. | Physical Exam for team sports |
| Chest x-ray referral. | Prenatal, natal, and post natal counseling |
| Diet counseling | Pre-entrance exams for transfer to other colleges |
| First Aid | Throat Culture for Streptococcus |
| Flu Vaccine (\$2.00) | Pregnancy test |
| Gonorrhea test | Rheumatoid Arthritis test |
| Health Counseling | Sickle Cell Anemia Test |
| Hearing test | Urinalysis test |
| Hemoglobin test | V.D.R.I. test |
| Mono test | Vision test |
| Paps Smear (\$2.50) | Weight control |
| Physical Exam for E.O.P. students | |

ACCIDENT INSURANCE

Your health service fee entitles you to an accident policy which covers accidents on campus.

SICK AND ACCIDENT INSURANCE (VOLUNTARY)

All students may purchase sick and accident insurance which covers them off campus 24 hours a day, 7 days a week. Automobile and Motorcycle Insurance may be purchased at a reduced rate for all students carrying 12 or more units and maintaining a "B" average.

TRANSPORTATION

The Ventura County Community College District does not provide student transportation to and from Moorpark College. Car pool information is maintained on the bulletin board in the Student Center.

HOUSING

As a service to students seeking off-campus housing accommodations, the Housing Office, located in the Student Center, keeps an up-to-date file of rooms and apartments listed with the college by various householders and landlords. These listings describe in detail the facilities being offered, but do not imply that the College has approved the accommodations. Selection of housing, financial arrangements, and rules and regulations covering behavior are the responsibilities of the student and the landlord.

VETERANS

The Veterans Clerk in the Records Office maintains liaison with the Veterans Administration and the State Department of Veterans Affairs.

Students planning to enroll and obtain benefits under Public Law 89-358 should contact the Veterans Clerk prior to registration.

Veterans are encouraged to complete the required Veterans Administration forms through the Ventura County Veterans Affairs Office.

Moorpark College does not grant credit for military training but will evaluate transcripts of extension and USAFI courses completed while in the military service.

The college is approved for training of veterans under all applicable laws.

student activities and organizations

The Associated Student Body of Moorpark College is the student governing organization. This organization carries the major responsibilities for student government, campus organizations and the student activity program in general. The broad aims of this program are in close harmony with the objectives of the college in providing opportunities for personal development, group cooperation, the development of leadership, and the enrichment of college life.

Moorpark College has a planned program of cultural, professional, and recreational activities. All students are encouraged to participate in one or more activities, such as student government, dramatics, music, forensics, athletics, publications, or the club program. It is felt that students availing themselves of these opportunities receive a more complete and rewarding college experience.

academic policies

GRADING SYSTEM

The quality of a student's work will be measured by a grading system as follows:

A-Excellent	4 grade points per unit
B-Good	3 grade points per unit
C-Average	2 grade points per unit
D-Minimum passing	1 grade point per unit
F-Failing	0 grade points per unit
I-Incomplete	0 grade points (no unit credit granted)
W-Withdraw	0 grade points (no unit credit granted)
CR-Credit	0 grade points (unit credit granted)
NC-No Credit	0 grade points (no unit credit granted)

INCOMPLETE GRADES

A grade of I (incomplete) is given to those students who fail to complete the required work of the course because of extenuating circumstances, e.g., missing the final examinations because of illness, or who have petitions granted to take late examinations.

If the student makes up the incomplete work within one semester, the instructor will assign a new letter grade. After one semester, if the incomplete work is not made up, the I grade automatically is converted to a grade of W.

WITHDRAWAL FROM COLLEGE

It is the student's responsibility to formally clear his record if he withdraws from college before the end of the semester. Grades at the time of withdrawal will be recorded according to the rules governing dropping of courses.

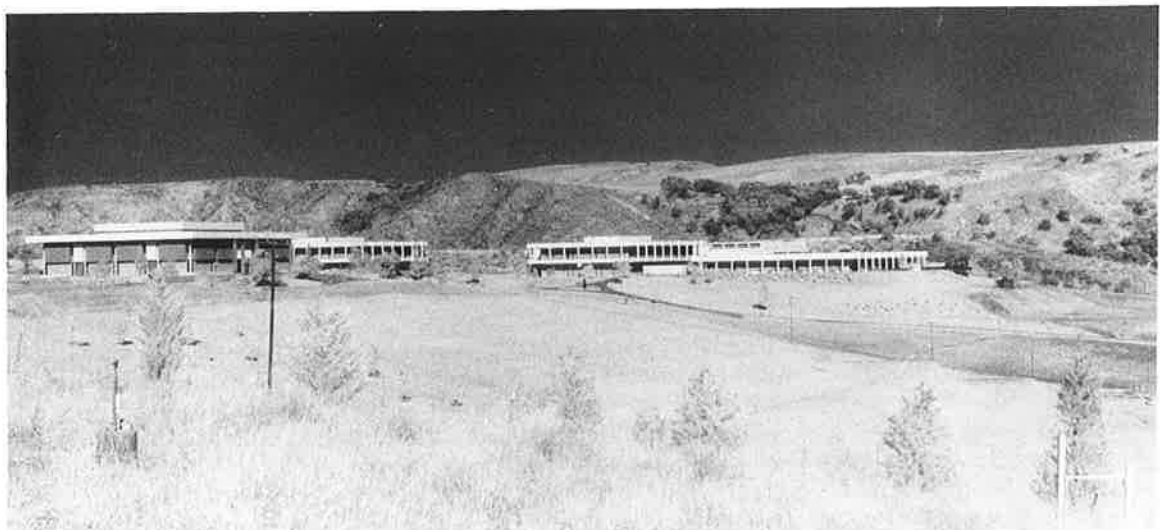

DROPPING A COURSE

The student may drop a course at any time during the semester. No grade check will be made during the first six weeks. Beginning with the seventh week, a student may be dropped with a "W" or with an "F", at the discretion of the instructor. The student dropping a course should notify his instructor and/or record the drop promptly in the Records Office.

REPEATED COURSES

A course in which a grade of "C" or better has been earned may not be repeated except as stated in the catalog course description or following a prolonged lapse of time between a prerequisite course and a subsequent course. A student must confer with the appropriate college administrative officer before repeating a course in which he has received a "C" or better letter grade. Any course in which a grade of "D" or "F" was earned may be repeated for the purpose of improving the recorded grade. The first grade may be lined through and omitted from the computation of cumulative grade point average. The second grade earned in such cases of repetition shall become the grade considered in computing the grade point average.

CREDIT BY EXAMINATION

Granting unit credit for a course by examination is based on the principle that previous experience, training, or instruction is the equivalent of a specific course taught in the college. If an examination indicates that the student possesses adequate equivalency and mastery of the subject, credit may be granted. The student's record shall show course identification and the number of units granted by examination; no letter grades shall be awarded. Each division of the college determines which of its courses for which credit by examination may be granted.

Exception to the above may be made when necessary to meet provisions of California state law or the rules and regulations of state agencies governing programs of the California Community Colleges.

For the purpose of this policy, a course shall mean an organized area of instruction of one semester's duration as described in the college catalog with units designated, and which is regularly offered on the schedule of classes. Regularly offered shall mean a frequency of not less than once in two years.

Credit by examination may be granted only to a student who is registered at the college and is in good standing.

The amount of unit credit granted by examination to an individual shall not count toward requirements of residency.

Moorpark College is authorized to grant credit by examination under the following conditions:

1. Students shall present written petitions for credit by examination. Approval may be granted by the Office of Instruction after consultation with and recommendation of appropriate staff members.
2. Course credit by examination shall not be permitted in the following areas:
 - a. Remedial courses
 - b. Courses where the materials have been satisfactorily completed at a previous school.

CREDIT-NO CREDIT

The student may enroll in specified courses under either the letter grading system or the "credit-no credit" grading system (except as indicated in the second paragraph). In both systems, the student participates in the course as a regular student. Under the "credit-no credit" system, if in the instructor's judgement the student satisfactorily completes the material (C grade or better), he will be assigned a "credit" grade for the course. If in the instructor's judgement, the student does not satisfactorily complete the course material, a "no-credit" grade will be assigned. A student may not enroll in more than 9½ units of "credit-no credit" courses in any one semester. Also, a student may not accumulate more than 20 units toward graduation under the "credit-no credit" system of grading.

All remedial courses, institutes, orientation courses and work experience courses will be under the "credit-no credit" system.

ADVICE TO STUDENTS CONCERNING CREDIT-NO CREDIT COURSES

In all cases students should complete course work in the area of their major on the letter grade basis. In addition, it is advisable that the student take the supporting courses which are affiliated with the student's major on a letter grade basis.

Enrollment in courses on a "credit-no credit" basis should only be attempted after consultation with the counselor to assure that the course work attempted will fit within the recommended patterns prescribed for the student's major by the anticipated transfer institution and this college's rules pertaining to the 9½ units per semester rule and the 20 units maximum rule for "credit-no credit" courses.

The student should discuss with each instructor the basis for earning credit in "credit-no credit" courses. The criteria for success in these courses is determined by the instructor.

WORK EXPERIENCE EDUCATION

Moorpark College offers an educational program in Vocational Work Experience that is designed to develop and coordinate the relationship between classroom instruction and on-the-job activities.

If you are currently employed at a job which is related to your occupational goal as indicated by your current college major, you may be eligible for enrollment and college credit in the Work Experience Education program.

For more detailed information on the Work Experience Education program, please turn to page in the Moorpark College Catalog.

DEAN'S LIST

Special recognition is accorded student who complete a program of 12 or more units with a 3.50 grade point average or higher during a semester. These students are placed on the Dean's List and given appropriate recognition on campus and in the community.

PROBATION-DISMISSAL POLICY

A. INTRODUCTION

Probation-dismissal principles and policies are designed to assist students to make progress toward realistic educational, vocational, and personal goals. Each student who chooses to enroll should be encouraged to take advantage of the opportunity to realize his full potential. Limitations regarding programs, courses, and unit loads are consistent with the philosophy of providing an opportunity to succeed. The following principles and policies are consistent with the provisions of the Education Code and Title 5 of the California Administrative Code.

B. PRINCIPLES GOVERNING THE ADMINISTRATION OF ADMISSION-PROBATION-DISMISSAL POLICIES

1. High school graduates or persons 18 years of age or older, capable of profiting from the educational programs offered, shall be admitted by the colleges of the District.
2. The admissions officer at each college shall have the responsibility of administering probation-dismissal policies.
3. Probation-dismissal policies, as applied to individual students, are to be administered in such a manner as to respect the integrity and privacy of the student.
4. A dismissed student who applies for readmission must make a written statement supporting his readmission. A student who is readmitted must, with the assistance of a counselor, undertake a thorough reassessment of his educational and vocational goals which shall be made a matter of record.
5. A student transferring to a Ventura County Community College District college from another college is subject to the same probation-dismissal policies as Ventura County Community College District students.



6. Admission to graded classes is conditional until complete transcripts have been received from previous schools and colleges attended.
7. A student subject to dismissal has the right of appeal for a review of his case.

C. RULES GOVERNING ACADEMIC PROBATION

1. A student placed on probation shall be provided individual counseling and guidance services, including regulation of his program according to subject matter prerequisites, aptitude and achievement.
2. A student will be placed on probation when his cumulative or semester grade averages fall below 2.00. Computations will be based on all college work attempted.
3. A student will be placed on probation when he has accumulated "no-credit" grades in at least one-half but not three-fourths of the units attempted under the "credit-no credit" system, or when, in the previous semester, he received "no-credit" grades in at least one-half but not three-fourths of the units attempted under the "credit-no credit" system.
4. A newly entering student who is not a high school graduate shall be placed on probation.
5. A newly entering student who is a high school graduate, but whose high school average for the last three years of high school attendance was less than 2.00 for all subjects attempted (excluding physical education and military sciences), shall be placed on probation.

D. RULES GOVERNING DISMISSAL

1. A student who does not meet District academic standards is subject to dismissal. Rules governing dismissal apply to any student who has attempted twelve (12) or more semester units or the equivalent.
2. A student shall be subject to dismissal when his grade averages for three consecutive semesters fall below 1.75. Computations will be based on all college work attempted.
3. A student shall be subject to dismissal when he has received "no-credit" grades in three-fourths or more of the units attempted under the "credit-no credit" system.
4. A student who, after two semesters of attendance, is deficient 20 grade points or more, shall be subject to dismissal.
5. A student dismissed under the above rules shall not be reinstated until a minimum of one semester (or two quarters) has elapsed after the dismissal.

E. EXCEPTIONS TO DISMISSAL

1. An exception to dismissal may be made in the event of extreme and unusual circumstances that can be documented by evidence provided by the student.
2. At each college of the District, a committee shall be established representing admissions, counseling, and instruction to rule on exceptions in the application of dismissal policies.



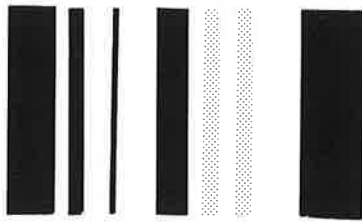

TRANSFER INFORMATION

Students may complete their program of freshman and sophomore courses at Moorpark College prior to transferring to a senior institution. Admission practices to four-year institutions are continually in the process of change. Students should therefore exercise care in checking entrance requirements at the college to which they intend to transfer. Moorpark College students who maintain the scholarship indicated below may expect to make a satisfactory transfer to the institution of their choice.

TO STATE COLLEGES: Students eligible for the State college on the basis of their high school record may transfer to the State college at any time as long as their community college grade-point average is 2.0 or better.

Students who were ineligible for the State college on the basis of their high school record will be admitted to the State college upon completion of 60 units of community college work and a 2.0 grade-point average. Students may transfer a maximum of 70 community college units to State colleges.

TO THE UNIVERSITY OF CALIFORNIA: Students eligible for admission from high school will be admitted to the University at any time as long as their community college grade-point average is 2.00 or better. Students ineligible for admission because of high school subject deficiencies may establish eligibility by completing the required courses with a C or better, and completing a minimum of 12 college units with at least a 2.00 grade-point average. Students ineligible for admission from high school because of grade-point deficiency may establish eligibility by taking a minimum of 56 acceptable units with a grade-point average of 2.00 or better.

Students may transfer a maximum of 70 community college units to the University of California.

CERTIFICATES OF COMPLETION

Moorpark College awards Certificates of Completion to students who have successfully completed specified courses in certain occupationally-related subject areas. These Certificates are available to students in two classifications: Occupational and One-Year.

The Occupational Certificate for in-service students requires completion of a minimum of 21 units of course work, including 6 units of general education, by a student regularly employed in the field to which the subject-matter major is related.

The One-Year Certificate for pre-service students requires completion of a minimum of 30 units of course work, including 9 units of general education, by a student preparing for a related occupational field. For both of these certificates 6 units of required course work in the major must be taken at the college. The specific requirements for each certificate are shown in the respective curriculum patterns in the catalog.



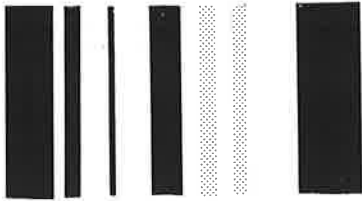

YEAR COURSES - Courses requiring a year (two semesters) in which to complete the full offering are designated by number and letter. (Example, History 15 A/B). The A section of the course is usually offered in the fall semester with the B section following in the spring. However, some year-sequence courses begin in the spring semester. For year-sequence classes, the "A" course is generally required as a prerequisite for the "B" course.

SEMESTER UNIT VALUES - The semester unit value of the course is shown by a number (or numbers in the case of year courses) following the title of the course. The semester unit is based on three hours of work-study; one lecture hour with two attendant hours of preparation or three hours of laboratory activity requiring special facilities or equipment. The standard credit allowance per semester for the course is stated in the description.

In order to meet specific needs in certain subject matter areas in the summer session and in the extended day program, the hours of instruction in some courses are changed and the credit changed proportionately. When an offering is changed from the hours and units as stated in the catalog, in the appropriate current class schedule the course will be identified by an "x" following the course number i.e., HE 10x.

TRANSFERABILITY - An indication of those courses which are acceptable for baccalaureate credit at 4-year institutions follows the course description. If the course has an equivalent or parallel at one of those institutions to which Moorpark College students frequently transfer, this equivalence is shown. If the course is given elective credit by a four-year California institution or if the course is considered to be baccalaureate level by Moorpark College, this information is clearly stated. Courses may be acceptable for transfer credit at other institutions, depending on their individual evaluations.

SCHEDULE OF COURSES - Courses listed are offered as a regular part of established curricula or when demand warrants. The current schedule should be consulted to determine the availability of specific courses.

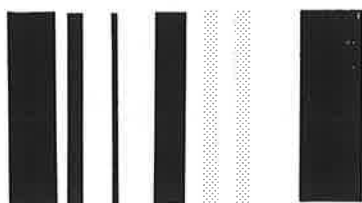

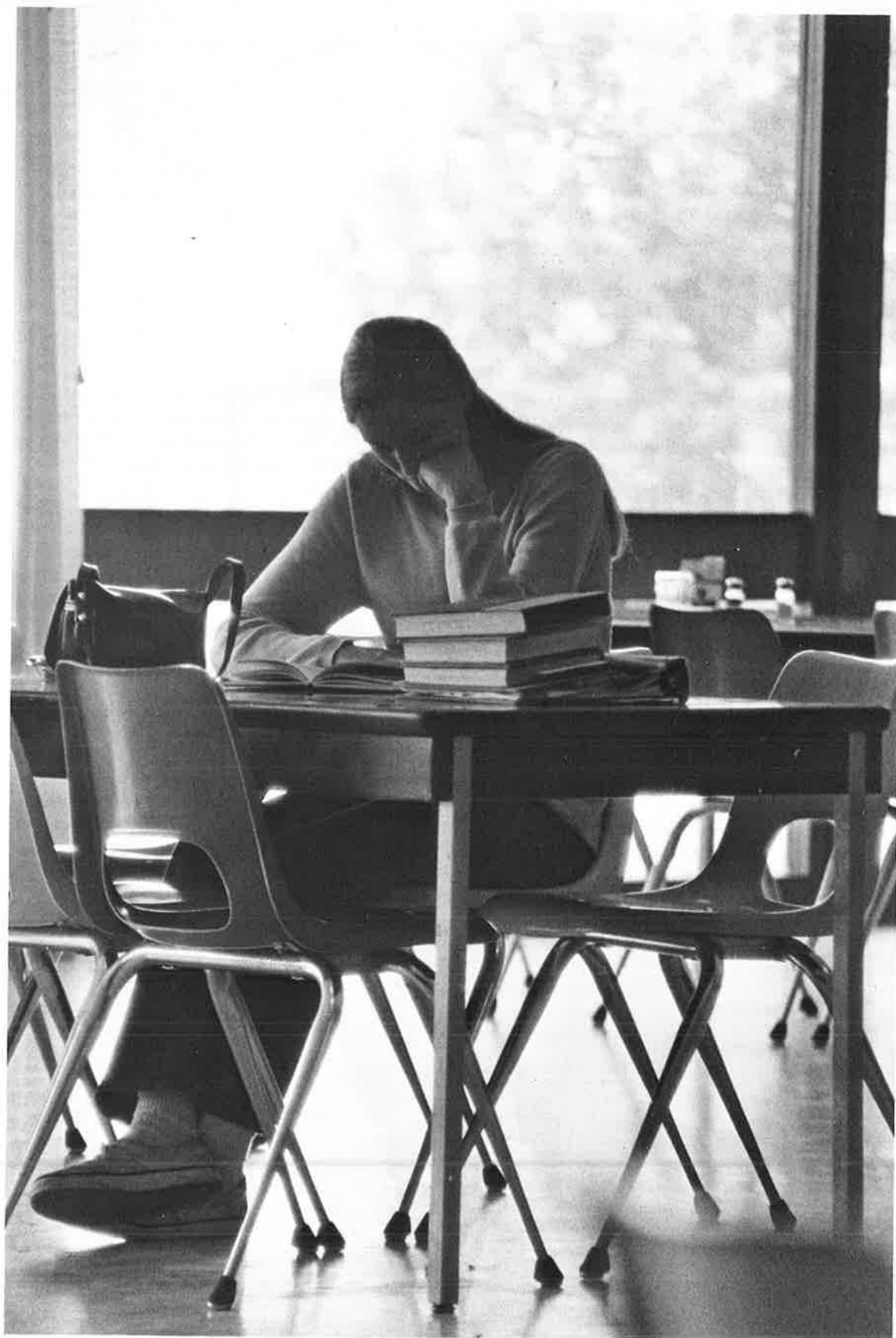

graduation requirements

for the associate of arts degree

As authorized by the Education Code and Title 5 of the Administration Code of the State of California, the Ventura County Community College District Board of Trustees confers the Associate of Arts degree to students who meet the following requirements and who file a Notice of Intent to Graduate.

A. GENERAL REQUIREMENTS

1. Completion of sixty (60) semester units of college work in a curriculum described in the college catalog with a grade point average of not less than 2.00.
2. A 2.00 grade point average in all work in residence which applies to the degree.
3. Completion of the last twelve (12) semester units in attendance at an institution of the Ventura County Community College District, or the completion of fifty-four (54) semester units in residence, if not in attendance at the time of qualifying for graduation.
4. Completion of a major consisting of at least twenty (20) semester units in a specified field of study.
5. Completion of not less than twenty-five (25) semester units in general education outside of the major field of study.

B. GENERAL EDUCATION REQUIREMENTS

Semester Units

- | | |
|---|-----|
| 1. Social Science
(Including at least three units in American History & Institutions.) | 6-9 |
| 2. English/Speech
3 to 6 units as required in transfer major. Must include at least three (3) semester units in English composition. | 6 |
| 3. Natural Science/Mathematics | 3-5 |
| 4. Fine Arts* | 2 |
| 5. Health Education | 2 |
| 6. Physical Education (4 semesters required) | 2 |

C. In designated occupational curricula, the Associate of Arts degree may be conferred in the specific field of study, such as electronics, business, fire science, etc.

D. A student who meets the requirements for transfer to a four-year college or university, and who has completed lower division subject requirements for entry into an upper division subject major, shall be deemed to have met the requirements of A-4 above.

*Music 17 may not be used to fulfill this requirement.

state college general education requirements

A Moorpark College student transferring to one of the California state colleges with 60 units of credit will satisfy the General Education breadth requirements for a bachelor's degree from the state college by completing the 40½ unit General Education pattern below. (The student is advised to consult the catalog of the state college he plans to attend for requirements unique to that college.)

I.	NATURAL SCIENCES	9 UNITS
II.	HUMANITIES	9 UNITS
III.	SOCIAL SCIENCES	9 UNITS
IV.	BASIC SKILLS	3½ UNITS
V.	BREADTH	6 UNITS
VI.	PHYSICAL EDUCATION & HEALTH	<u>4 UNITS</u>
	TOTAL	40½ UNITS

I. NATURAL SCIENCES

A minimum of 9 units of Natural Sciences with at least one course from each of the following groups and including one laboratory course from either group:

GROUP A

An 1	General Human Anatomy
Anth 1	Physical Anthropology
Biol 1	Principles of Biology
Biol 2A/B	General Biology
Biol 3A/B	Marine Biology
Biol 10	Seashore Life
Bot 1	General Botany
Bot 3A/B	Plant Identification
Bot 4A/B	Botany Workshop
Env. Sci. 2	Environment and Man
Micro 1	Principles of Microbiology
Phys 1	Intro to Human Physiology
Zoo 3A/B	Vertebrate Natural History

Geol 2	Physical Geology
Geol 2L	Physical Geology Lab
or	
Geol 31	Rocks & Minerals
Geol 3	Historical Geology
Geol 17A/B	Mineralogy-Petrology
Geol 21	Geology of California
Geol 41	Geology of National Parks & Monuments

GROUP B

Chem 1A/B	General Chemistry
Chem 5	Quantitative Analysis
Chem 7A/B	Organic Chemistry
Chem 10	
A/B/C	Descriptive Chemistry
Chem 12	Elementary Chemistry I
Chem 13	Elementary Chemistry II
Env. Sci. 1	Environmental Science
Geog 1	Physical Geography
Geog 5/	
Phys Sci 5	Introduction to Meteorology

Geol 51	Western Field Geology
Ph 2A/B	General Physics
Ph 3	The Art of Experimental Investigation
Ph 4	Mechanics of Physics
Ph 5	Electricity & Magnetism
Ph 6	Optics & Modern Physics
Ph 10	Descriptive Physics
Ph 11A/B	Technical Physics
Ph 12A/B/C	Applied Physics
Phys Sci 1	Introduction to Physical Science
Phys Sci 10	Sky and Telescope

II. HUMANITIES

A minimum of 9 units from the Humanities with at least one course from each of the following groups:

GROUP A

A minimum of 3 units of work from any Art or Music course (with the exception of Music 17) or Humanities 6, 8, 15 or 16.

GROUP B

Any two 1½ unit course from the English 1 series (in addition to courses from Section 4, Group A.)

GROUP C

Broad 1/ Journ 1	Mass Communications	Foreign Language	
Cine 1	History of Motion Picture	Hist 1A/B	Introduction to Western Civilization
Cine 2A/B	Art & Technique of Film	Hum 6	Art & the Written Word
Engl 10A/B	Creative Writing	Journ 2	News Reporting & Writing
Engl 11/ Broad 5	Radio & Television Writing	MAS 2	Mexican-American Culture
Engl 13	Major Mexican Writers	MAS 13A/ ThA 11A	Contemporary Mexican-American Theatre
Engl 15A/B	Survey of English Lit	Phil 1A	Intro to Philosophy
Engl 17	Shakespeare	Phil 2	Intro to Logic
Engl 18	Modern American Novels	Phil 3	Comparative Religions
Engl 19	Intro to Short Story	Phil 10	Contemporary Black Thought
Engl 21	Contemporary Novels	Phil 11	Psychology of Religion - East & West
Engl 25/ ThA 25	Playwriting	Phil 12	Religion, Values, & Peak Experiences
Engl 27/Fr 4	Contemporary French Literature in Translation	Phil 15	Contemporary Religions & Philosophies: A Cross-section
Engl 28/ Spn 4	Hispanic Culture & Civilization	Photo 1A	Beginning Photography
Engl 30	Masterpieces of World Literature	Speech 1	Intro to Speech
Engl 31	Masterpieces of World Literature	Speech 2	Elements of Public Speaking
Engl 35A/B	Survey of American Literature	Speech 5	Elementary Oral Interpretation
Engl 45	Mexican-American Literature in English	Speech 16/ ThA 16	Readers Theatre
Engl 46	Afro-American Literature in English	ThA 1	Introduction to the Theatre
		ThA 2A	Fundamentals of Acting

III. SOCIAL SCIENCES

A minimum of 9 units from the Social Sciences with at least one course from each of the following groups:

*GROUP A

Hist 4/ MAS 4	History of the Mexican People in SW
Hist 5	United States History
Hist 7A/B	Social/Political History of U.S.

*GROUP B

PSc 1	Intro to Government
PSc 2	Comparative Government
PSc 3	American Government
PSc 8	Political Patterns in the U.S.
PSc 9	Adjudication of Social Issues
PSc 10	Public Administration & Policy Dev.
MAS 8	Political Patterns in the Southwest
Urban 1A/B	Contemporary Urban Issues

GROUP C

Anthro 2	Cultural Anthropology
Anthro 3	Archaeology
Anthro 5	Field Archaeology
Anthro 7	Peoples & Cultures of the World
BSci 1	Intro to Behavioral Sciences
BSci 2	Interpersonal Behavior
Econ 1A/B	Principles of Economics
Geog 2	Elements of Cultural Geography
Geog 3	Geography of World Affairs
Geog 9	Environmental Design
Geog 10	Geography of California
Hist 3	Afro-American History
Hist 6	History of the American Indian
Hist 8	History of California
Hist 9A/B	History of the Americas
Hist 10A/B	African History
Hist 15A/B	Intro to History of Asia
MAS 1	Mexican-American in Contemporary Society

All courses qualify in A & B for H & I requirement

MAS 7	Field Work in Barrio Studies	Psych 4	Child Psychology
PSc 4	International Relations	Psych 5	Social Psychology
PSc 7	Minority Groups	Psych 6	The Psychology of Women
Psych 1A	Intro to Psychology	Soc 1	Intro to Sociology
Psych 1B	Intro to Experimental Psychology	Soc 2	Social Problems
Psych 2	General Psychology	Soc 3	Social Analysis
Psych 3	Personal & Social Adjustment	Soc 5	Minority Group Relations

IV. BASIC SKILLS

A minimum of 3½ units with at least one course from each of the following groups:

GROUP A

One 1½ unit course from the English 1 series (in addition to courses from Section 2, Group B)

GROUP B

Bus 1A	Accounting Principles	Read 4A	Techniques of REading
DP 1	Introduction to Data Processing	Speech 1	Intro to Speech
Math 3	Intermediate Algebra	Speech 2	Elements of Public Speaking
Math 7	College Algebra & Trigonometry	Speech 5	Elementary Oral Interpretation
Math	All Math classes numbered 10 and above except Math 41 A/B/C, Math 48A/B and Math 49A/B.	ThA 2	Fundamentals of Acting
		ThA 10	Rehearsal of Performance
		ThA 11B	Contemporary Mexican-American Theatre
Phil 2	Intro to Logic		

V. BREADTH ELECTIVES

A minimum of 6 units of course work from any of the courses listed in the four basic areas provided the courses are outside the student's major. Additional courses which may be selected include the following:

Bus 29	Intro to Business & Economics	Hum 1A or	
ECD 30A	Child Growth & Development	1B	Man in Society
Engr 4	Engineering Graphics w/Descriptive Geometry	PG 1	Personal Growth - Rap/focus
HE 10	Nutrition	Rec 1	Intro to Community Recreation

VI. PHYSICAL EDUCATION AND HEALTH

A minimum of 4 units is required in the area of Health Education and Physical Education. A 2-unit course in Health Science is required and at least 2 units in Physical Education activity courses.

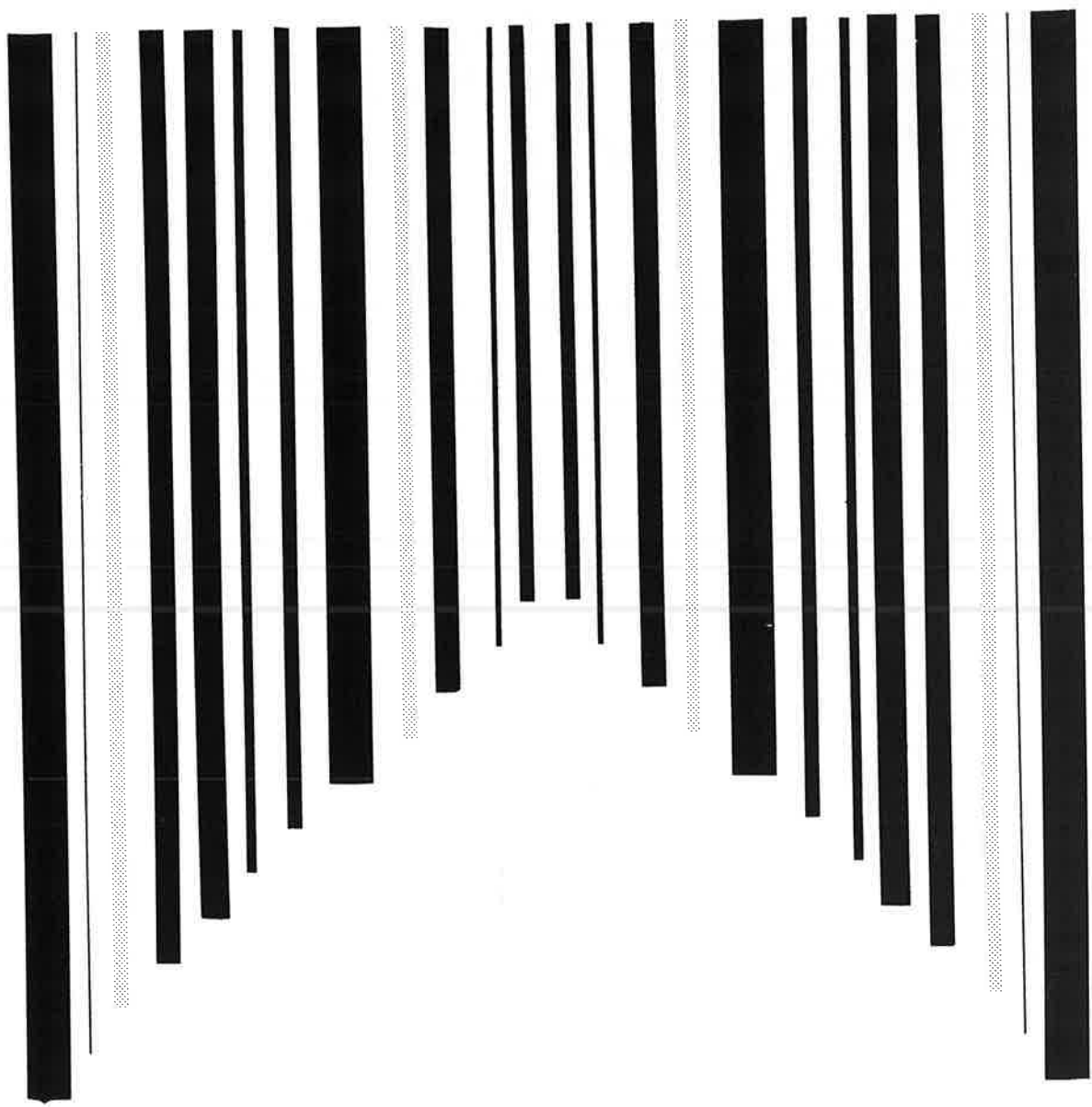

programs & courses

administration of justice

The Administration of Justice Program offers a variety of options including Law Enforcement, Judicial Systems, Crime Prevention and Corrections, Criminal Identification and Investigation, Industrial Security and Pre Law. This program is designed for students who seek either an AA degree or those who plan to transfer to a state college or university.

REQUIRED CORE COURSES IN THE MAJOR (15 UNITS)

AJ 1	Introduction to the Administration of Justice
AJ 4	Concepts of Criminal Law
AJ 7	Community Relations
AJ 8	Legal Aspects of Evidence
AJ 15	Principles and Procedures of the Justice System

AREA OF SPECIALIZATION (6-9 UNITS)

Students may specialize in any one or more of six areas. The courses in each area, in addition to the above core courses, are as follows:

I. Law Enforcement	II. Judicial Systems
AJ 9 Firearms	AJ 14 Juvenile Procedure
AJ 10 Patrol Procedures	AJ 27 Civil Duties and Procedures
AJ 11 Criminal Investigation	AJ 28 Court Administration
AJ 12 Defense Tactics	
HS 5 Safety and First Aid	
III. Crime Prevention & Correctional Services	IV. Criminal Identification and Investigation
AJ 41 Intro to Probation, Parole and Corrections	AJ 11 Criminal Investigation
AJ 42 Interpersonal Relations	AJ 16 Arrest, Search and Seizure
AJ 43 Interviewing, Counseling and Tutoring	AJ 18 Narcotic Investigation
AJ 44 Techniques of Group Counseling	AJ 19 Vice Investigation
	AJ 21 Introduction to Criminalistics
V. Industrial Security	VI. Pre Law Option (Choose 3-5 classes)
AJ 9 Firearms	AJ 1 Introduction to the Administration of Justice
AJ 16 Arrest, Search and Seizure	AJ 4 Concepts of Criminal Law
AJ 46 Security Administration	AJ 8 Legal Aspects of Evidence
AJ 47 Environmental Security	AJ 15 Principles and Procedures of the Justice System
	AJ 28 Court Administration

[REDACTED]

courses in administration of justice

AJ 1 - INTRODUCTION TO THE ADMINISTRATION OF JUSTICE

3 Units

Prerequisites: None
3 hours lecture weekly

The history and philosophy of administration of justice in America; recapitulation of the system; identifying of the various sub-systems, role expectations, and their interrelationships; theories of crime, punishment and rehabilitation; ethics, education and training for professionalism in the system.
Equivalent to PSA 101, CSULA

AJ 4 - CONCEPTS OF CRIMINAL LAW

3 Units

Prerequisites: None
3 hours lecture weekly

Historical development, philosophy of law, and constitutional provisions; definitions, classification of crime, and their application to the system of Administration of Justice; legal research, study of case law, methodology, and concepts of law as a social force.
Equivalent to PSA 126, CSULA

AJ 5 - INVESTIGATIVE REPORT WRITING

1 Unit

Prerequisite: Sheriff's Academy Recruit
3 hours lecture weekly (six weeks)

Covers fundamentals of basic report writing from spelling, sentence formation and punctuation to writing a paragraph, theme and technical report.

AJ 7 - COMMUNITY RELATIONS

3 Units

Prerequisites: AJ 1 & AJ 4
3 hours lecture weekly

An in-depth exploration of the roles of the Administration of Justice practitioners and their agencies. Through interaction and study the student will become aware of the interrelationship and role expectations along the various agencies and the public. Principal emphasis will be placed upon the professional image of the system, Justice Administration and the development of positive relationships between members of the system and the public.
Baccalaureate Level

AJ 8 - LEGAL ASPECTS OF EVIDENCE

3 Units

Prerequisites: AJ 1, AJ 4, and AJ 15
3 hours lecture weekly

Origin, development, philosophy, and constitutional basis of evidence; constitutional and procedural considerations affecting arrest, search and seizure; kinds and degrees of evidence and rules governing admissibility; judicial decisions interpreting individual rights and case studies.
Equivalent to PSA 221, CSULA

[REDACTED]

AJ 9 - FIREARMS

1 Unit

Prerequisite: AJ 1 and AJ 4 or consent of instructor
3 hours laboratory weekly

The moral aspects, legal provisions, safety precautions and restrictions covering the use of firearms; firing of the side-arm and shotgun.
Equivalent to PSA 283, CSULA

AJ 10 - PATROL PROCEDURES

3 Units

Prerequisite: AJ 1 and AJ 4 or consent of instructor
3 hours lecture weekly

Responsibilities, techniques, and methods of police patrol.
Equivalent to PSA 238, CSULA

AJ 11 - CRIMINAL INVESTIGATION

3 Units

Prerequisites: AJ 1, AJ 4 and AJ 15 or consent of instructor
3 hours lecture weekly

Fundamentals of investigation; crime scene search and recording; collection and preservation of physical evidence; scientific aids, modus operandi, sources of information; interviews and interrogations; follow-up and case preparation.
Equivalent to PSA 235, CSULA

AJ 12 - DEFENSE TACTICS

1 Unit

Prerequisites: AJ 1 and AJ 10 or consent or instructor
3 hours activity weekly

Protection against persons armed with dangerous and deadly weapons; demonstration and drill in a limited number of holds and come-alongs; restraint of prisoners and the mentally ill; fundamental use of the baton. This course fulfills PE 1 requirement of Law Enforcement majors.
Equivalent to PSA 282, CSULA

AJ 13 - TRAFFIC CONTROL AND INVESTIGATION

3 Units

Prerequisites: AJ 1, AJ 4 and AJ 15 or consent of instructor
3 hours lecture weekly

Traffic law enforcement, regulation, and control, fundamentals of traffic accident investigation; California Vehicle Code.
Equivalent to PSA 236, CSULA

AJ 14 - JUVENILE PROCEDURE

3 Units

Prerequisites: AJ 8, AJ 10 and AJ 15 or consent of instructor
3 hours lecture weekly

The organization, functions, and jurisdiction of juvenile agencies; the processing and detention of juveniles; juvenile case disposition; juvenile statutes and court procedures.
Baccalaureate Level

AJ 15 - PRINCIPLES AND PROCEDURES OF THE JUSTICE SYSTEM

3 Units

Prerequisites: AJ 1 and AJ 4
3 hours lecture weekly

An in-depth study of the role and responsibilities of each segment within the administration of justice system: law enforcement, judicial, corrections. A past, present, and future exposure to each sub-system procedures from initial entry to final disposition and the relationship each segment maintains with its system members.
Baccalaureate Level

AJ 16 - ARREST, SEARCH, AND SEIZURE

3 Units

Prerequisites: AJ 4, AJ 8, and AJ 15 or permission of instructor
3 hours lecture weekly

Admissibility of evidence and confessions; recent judicial decisions interpreting civil rights; problems involving the reconciliation of individual rights and collective security and the prevention of criminality. Special emphasis on the Bill of Rights and major enforcement problems and constitution limitations in perspective.
Baccalaureate Level

AJ 17 - FINGERPRINT AND DOCUMENT EXAMINATION

3 Units

Prerequisites: AJ 11 or permission of instructor
3 hours lecture weekly

Basics of fingerprinting, fingerprint pattern interpretation, fingerprint classification and searching, development of latent prints; the fundamentals of handwriting and questioned document comparison; exemplar preparation, check classification, court preparation and presentation.

AJ 18 - NARCOTICS INVESTIGATION

3 Units

Prerequisite: Peace Officer or permission of coordinator
3 hours lecture weekly

The identification of marijuana, opiates, cocaine, dangerous drugs, hallucinogens, and their paraphernalia. Principles of identifying and dealing with the "user." Laws and court decisions relating to the offender, fundamentals of arrest, search, report writing, and court testimony. The prevention and control of drug abuse as it relates to society.
Baccalaureate Level

AJ 19 - VICE CONTROL

3 Units

Prerequisite: Peace officer or permission of coordinator
3 hours lecture weekly

Detection, repression and control of vice, gambling, prostitution, liquor law and sex offender violation. Vice law and court procedures. The course is intended to provide knowledge and skill in the recognition, investigation and control of vice offenders.
Baccalaureate Level

AJ 20 - POLICE ADMINISTRATION

3 Units

Prerequisites: Police Officer or permission of coordinator
3 hours lecture weekly

Administrative, management and organization principles applicable to law enforcement agencies. Fundamentals of organization and management of patrol, traffic, detective, juvenile, vice, records and detention units. Personnel management, fiscal planning, manpower deployment, formulation of policies and regulations.
Baccalaureate Level

AJ 21 - INTRODUCTION TO CRIMINALISTICS

3 Units

Prerequisites: Peace officer or permission of instructor
3 hours lecture weekly

Collection, preservation, analysis and interpretation of physical evidence of various types including: fingerprints, footprints, tire tracks, tool marks, blood and glass; photographic techniques. Ultra-violet and infrared techniques. Firearms identification. Silicone rubber, plaster of paris and moulage casting of impressions.
Baccalaureate Level

**AJ 22A/B - DIRECTED STUDIES IN ADMINISTRATION
OF JUSTICE**

1-3/1-3 Units

Prerequisites: A course in the specific field and permission of the coordinator and Division Chairman
1-3 hours tutorial weekly

Designed for selected students who are interested in furthering their knowledge of law enforcement on an independent study basis. Assigned problems will involve library, laboratory, and field work. Maximum of 6 units.

AJ 25 - RESCUE FIRST AID

2 Units

Prerequisites: Sheriff's Academy Recruit
6 hours lecture weekly - (six weeks)

The human body, emergency care of victims, child birth, artificial respiration, toxic gasses, chemicals and diseases, radioactive hazards, rescue problems and techniques. The prevention of shock, unconsciousness and poisons; treatment of fractures; administration of dressings and bandages; care and treatment of vehicular and other emergency related injuries. Successful completion of this course qualifies for the standard or advanced "American Red Cross First Aid to the Injured" Certificate.

AJ 27 - CIVIL DUTIES AND PROCEDURES

3 Units

Prerequisite: Peace officer or permission of coordinator
3 hours lecture weekly

The duties, rights, and liabilities of marshals, civil deputies, peace officers and clerical personnel in civil law enforcement. Includes levies, service of civil process, third party claims, writs, sales and delivery actions.

AJ 28 - COURT ADMINISTRATION

3 Units

Prerequisites: AJ 1 or AJ 41
3 hours lecture weekly

A study of court management and the role of the court administrators; duties and responsibilities of magistrates, court officers and attaches; emphasis on new dimensions of court reform and court management techniques.

AJ 30 - ADVANCED OFFICER TRAINING

3 Units

Prerequisites: Employed peace officer and permission of Coordinator
3 hours lecture weekly

A course of study designed to keep peace officers informed of new laws, recent court decisions, current enforcement procedures, new concepts in police technology, community-police relations, law enforcement ethics, and police integrity.

AJ 31 - POLICE SUPERVISION (P.O.S.T. PRE-SUPERVISORY)

4 Units

Prerequisites: Employed peace officer certified to supervisory position
80 hours lecture

An 80-hour course certified by the commission on Peace Officer standards and training (P.O.S.T.) designed for first line law enforcement supervisors. Duties and responsibilities of the police supervisor and supervisory training function are stressed.

AJ 32 - POLICE SUPERVISION - IN-SERVICE**3 Units**

Prerequisites: Administration of Justice course or permission of instructor
51 hours lecture

A course designed for regular and reserve officers and first and second line supervisors. Duties and responsibilities of the police supervisor, analysis of personnel problems, complaints, and grievances; employee relations; principles of efficient leadership.
Baccalaureate Level

**AJ 40 - SEMINAR ON CRITICAL ISSUES IN
LAW ENFORCEMENT****1 Unit**

Prerequisite: Peace officer or permission of instructor
20 hours lecture

A P.O.S.T. certified short course designed to facilitate discussion of critical issues and contemporary problems faced by law enforcement. Emphasis on small group discussions and interaction led by recognized authorities and experts in the criminal justice field.

**AJ 41 - INTRODUCTION TO PROBATION, PAROLE
& CORRECTIONS****3 Units**

Prerequisites: None
3 hours lecture weekly

An introduction to the legal and practical aspects, practices, and procedures of probation and parole including an analysis of both with emphasis on rehabilitation and classification methods in criminology.

AJ 42 - INTERPERSONAL RELATIONS**3 Units**

Prerequisites: AJ 41 or taken concurrently
3 hours lecture weekly

Knowledge and skills leading to effectiveness in interpersonal relations and increased understanding of self and others, with emphasis on facilitating effective communication.

AJ 43 - INTERVIEWING, COUNSELING AND TUTORING**3 Units**

Prerequisites: AJ 42 or taken concurrently
3 hours lecture weekly

Introduction to the principles and practices of interviewing, counseling and tutoring. An integral part of the two-year curriculum in correctional services, designed to answer the national need of the "new careers" on all academic levels in people-to-people services. These include counselor and group counselor aides, teacher aides, eligibility workers, social worker technicians, and other pre-professional positions. (Co-number Urban 43)

AJ 44 - TECHNIQUES OF GROUP COUNSELING**3 Units**

Prerequisites: AJ 42 or AJ 43
3 hours lecture weekly

Techniques of counseling in groups with people of a variety of ages. Group exploration and sharing of feelings about problems presented. Recognition of unique and common problems, and participation in understanding and behavior change. (Co-number Urban 44)

AJ 50 - LAW ENFORCEMENT INSTITUTES**1-3 Units**

Prerequisite: Criminal Justice Personnel or permission of Coordinator

A short term lecture series on specialized law enforcement technology designed for criminal justice personnel.

For information regarding Work Experience Credit in the Administration of Justice program, refer to Page 224 in this catalog.

agriculture

Faculty: Donald Anderson, R. Bruce Spiller

general agriculture

The general agriculture major prepares students for diversified farming where a knowledge of farm crops, livestock, and farm machinery is necessary. The curriculum is not intended to replace majors of Agriculture in which students specialize in a single field. The requirements are flexible and especially well adapted to students interested in teaching vocational agriculture. Many graduates have found positions with county, state, and federal agencies, or in business and services related to agriculture.

REQUIRED COURSES IN THE MAJOR

CSU, Fresno		Cal Poly, SLO	
AB 2	Record Keeping	AB 2	Record Keeping
AH 1	Intro Animal Husbandry	AH 1	Intro Animal Husbandry
AH 2	Feeds & Feeding	AH 2	Feeds & Feeding
Agron 1	Intro to Agronomy	Agron 1	Intro to Agronomy
Ag 21	Soils	Ag 21	Soils
Bot 1	General Botany	Bot 1	General Botany
Chem 12	Elementary Chem I	Chem 12	Elementary Chem I
Econ 1A	Principles of Economics	Ent 1	Economic Entomology
Ent 1	Economic Entomology	Hort 1	Intro to Horticulture
Hort 1	Intro to Horticulture	Math 1A/B	Elementary Algebra
Math 3	Intermediate Algebra	Math 3	Intermediate Algebra
		Micro 1	Principles of Microbiology

animal husbandry/agri-business

This program provides training in the selection, care, development, and marketing of commercial animals for sale. There are many current employment opportunities in our community, positions requiring this training, e.g., livestock grower and meat wholesaler.

REQUIRED COURSES IN THE MAJOR

AH 1	Introductory Animal Husbandry
AH 2	Feeds & Feeding
AB 1	Introduction to Agriculture Business
AB 2	Record Keeping
Agron 1	Introduction to Agronomy

forestry technician

The program in Forestry provides a broad general education in the arts and sciences to develop an individual with a broad and well-rounded education; and a core of basic courses which furnish the student with a perspective of the scientific and professional area of Forestry.

REQUIRED COURSES IN THE MAJOR

CSU, Humboldt

For 1	Intro to Forestry
For 2	Natural Resources
Ag 21	Soils
Biol 2A	General Biology
Bot 1	General Botany
Bot 3	Plant Identification
Math 7	Col. Alg & Trig.
Math 25A	Cal/Analytic Geom.
Engr 8A	Plane Surveying
DP 1	Intro to Data Processing
DP 4A	Computer Programming

University of California, Berkeley

Biol 2A/B	General Biology
Chem 1A/B	General Chemistry
Ph 2A/B	General Physics
Econ 1A/B	Principles of Economics
Geol 2	Physical Geology
Geol 2L	Physical Geology Lab
Math 15	Intro Statistics
Math 16A/B	Applied Calculus
Engr 8A	Plane Surveying

landscape horticulture

This program is designed to provide a background of education and experience in Landscape Horticulture with some training in the business field. The change from rural to suburban living and development of recreational facilities is creating an increasing demand for persons in this field.

REQUIRED COURSES IN THE MAJOR

Hort 1	Introduction to Horticulture	Ent 1	Economic Entomology
Hort 2	Plant Structure	AB 1	Introduction to Agriculture Business
Hort 3	Plant Propagation	Hort 5	Landscape Construction and Maintenance
LH 25A/B	Turfgrass Management	Hort 6	Landscape Design
Hort 4	Plant Identification		
Ag 21	Soils		

natural resources technician

Forests, rangelands, wildlife and water are part of our country's great wealth of natural resources. This program is designed to train forestry aides or forestry technicians who assist foresters in managing and caring for both public and private forest lands. Primarily, employment opportunities are with the State and Federal Government.

REQUIRED COURSES IN THE MAJOR

For 1	Introduction to Forestry
For 2	Natural Resources
For 3	Forest Protection
For 4	Fish and Game Management
AH 1	Introductory Animal Husbandry
Hort 3	Plant Propagation
Hort 4	Plant Identification
Ag 21	Soils
Ent 1	Economic Entomology



courses in agriculture

AB 1 - INTRODUCTION TO AGRI-BUSINESS

3 Units

Prerequisites: None
3 hours lecture weekly

Business principles as they apply to agriculture business enterprises in related agricultural areas that service and supply production agriculture, i.e., agricultural chemical sales and services, agricultural equipment sales and services, and others.
Equivalent to ABM 101, Cal Poly SLO

AB 2 - RECORD KEEPING

3 Units

Prerequisites: None
2 hours lecture, 3 hours laboratory weekly

The study of basic record keeping procedures used in production agriculture.
Required course for all *agriculture students*.
Equivalent to FM 102, Cal Poly SLO

Agron 1 - INTRODUCTION TO AGRONOMY

3 Units

Prerequisites: None

2 hours lecture, 3 hours laboratory weekly

Plant structures and their functions; crop ecology and basic factors affecting crops and crop production. Identification of crops, seeds and weeds. Weed control in this locality. Seed production, including certified seed.

Equivalent to CP 131, Cal Poly SLO

Parallels Plant Science 1, UC Davis

Ag 10 - AGRICULTURE CONSTRUCTION AND MAINTENANCE

2 Units

Prerequisites: None

1 hour lecture, 3 hours laboratory weekly

Construction techniques, materials, structural planning and maintenance of agricultural structures and equipment. Carpentry and masonry tools, hardware and materials as applied to construction and maintenance of various agricultural structures. Use of hand and power equipment.

Equivalent to AE 121, Cal Poly SLO

Ag 21 - SOILS

3 Units

Prerequisites: None

2 hours lecture, 3 hours laboratory weekly

Physical, chemical, and biological properties of soils, the factors determining productivity; soil classification interpretation and evaluation of soil practices used in agriculture; laboratory work in soil sampling and testing, organic materials and microbiology, alkaline soils and reclamation; use of soil maps; soil and water experiments.

Equivalent to SS 121, Cal Poly SLO

Parallels Soil and Water Science 1, UC Davis

Ag 22A/B - DIRECTED STUDIES IN AGRICULTURE

1-3/1-3 Units

Prerequisites: A specific course in the field and consent of the instructor and Division Chairman

1-3 hours tutorial weekly

Designed for selected students who are interested in furthering their knowledge of agriculture on an independent study basis. Assigned problems will involve library, laboratory, and field work. Maximum of 6 units.

AH 1 - INTRODUCTORY ANIMAL HUSBANDRY

3 Units

Prerequisites: None

2 hours lecture, 3 hours laboratory weekly

Survey of livestock production in the community, state, nation and world. Study of anatomy and physiology, genetics, nutrition, livestock selection, management, and marketing of the breeds of beef, dairy, swine, sheep and poultry and their products.

Equivalent to AH 230, Cal Poly SLO

Parallels Animal Science 1, UC Davis

AH 2 - FEEDS AND FEEDING

3 Units

Prerequisite: AH 1

2 hours lecture, 3 hours laboratory weekly

Nutritional requirements of livestock. Balancing of feed rations. Costs of feed rations. (F)

Equivalent of AH 121, Cal Poly SLO

Parallels Animal Science 1, UC Davis

AH 3 - SELECTION - LIVESTOCK**3 Units**

Prerequisite: AH 1

2 hours lecture, 3 hours laboratory weekly

Techniques and procedures used in livestock selection. (F,S)
 Equivalent to ASCI 226, Cal Poly SLO

AH 4 - LIVESTOCK MANAGEMENT**3 Units**

Prerequisite: AH 1

2 hours lecture, 3 hours laboratory weekly

The development of a total livestock management program applied to a basic economic unit in agriculture. Use of budgets, inventories, and cost accounting in livestock practices. (F)
 Baccalaureate Level

AH 5 - HORSE HUSBANDRY I**3 Units**

Prerequisites: None

2 hours lecture, 3 hours laboratory weekly

Care of horse and equipment, use and nomenclature of animals and equipment, types of breeds and use, appreciation of riding animal and its relationship to the environment. Field trips to local equine centers. (F)
 Equivalent to ASCI 232, Cal Poly SLO

AH 6 - HORSE HUSBANDRY II**3 Units**

Prerequisites: AH 5

2 hours lecture, 3 hours laboratory weekly

Horse ranch management, breeding and care of the mare and foal, basic training techniques, outside speakers on disease and insect control, and above referenced topics. Field trips to local equine centers.
 Equivalent to ASCI 333, Cal Poly SLO

AH 7A/B - LECTURES IN HORSE HUSBANDRY**2-2 Units**

Prerequisites: None

2 hours lecture weekly

Lecture series based on the selection, health and care of riding horses. Lectures to be given by knowledgeable people in the particular areas of concern. Topics include quarter horse selection; arabian horse selection; saddle breeds and selection; thoroughbred selection; inoculations; safety; common diseases; feeds; and colt care.
 Baccalaureate Level

AH 8 - EQUITATION**2 Units**

Prerequisites: None

1 hour lecture, 3 hours laboratory weekly

Beginning riding techniques, care and use of horse and equipment, safety and first aid, types of riding and equipment, appreciation of the animal, and its relationship to the environment. (Co-number P.E. 5)
 Baccalaureate Level

Ent 1 - ECONOMIC ENTOMOLOGY**3 Units**

Prerequisites: None

2 hours lecture, 3 hours laboratory weekly

Common insects that attack agricultural crops and stored products; basic taxonomy of the major orders; identification, life cycles, habits, hosts, economic importance, and control of the principal insects in agriculture; identification and evaluation of beneficial insects. Insect collection required.

Equivalent to CRSC 311, Cal Poly SLO

Parallels Entomology 10, UC Davis



For 1 - INTRODUCTION TO FORESTRY

3 Units

Prerequisites: None

2 hours lecture, 3 hours laboratory weekly

An introduction to the occupations and professions in the general area of natural resources with emphasis on the general principles underlying the management of forests, parks, wild game and fisheries. Weekly field trips will take students to the local natural resources agencies.

Equivalent to NRM 101, Cal Poly SLO

Acceptable for credit at UC (all branches)

For 2 - NATURAL RESOURCES

3 Units

Prerequisites: None

3 hours lecture weekly

Economic and social values of our natural resources. History of man in relation to land use, human population in relation to resources; history of the conservation movement; present day conservation practices.

Equivalent to NRM 112, Cal Poly SLO

Acceptable for credit at UC (all branches)

For 3 - FOREST PROTECTION

3 Units

Prerequisites: None

2 hours lecture, 3 hours laboratory weekly

Forest production, including principles of combustion, weather, fire control, topography, fuels, classes of fires and fire behavior. Fire prevention including fire suppression and fire equipment. Enemies of the forest, including disease, insects, fungi, animals, etc.

Equivalent to NRM 102, Cal Poly SLO

For 4 - FISH AND GAME MANAGEMENT

3 Units

Prerequisites: None

2 hours lecture, 3 hours laboratory weekly

A study of fish culture including operation of facilities for production of sport and commercial fish; management, feeding, parasites and diseases. Management of species of small and large game mammals, their life histories, distribution, management and conservation.

Accepted for credit at Cal Poly SLO

For 5 - PARK SITE DEVELOPMENT

3 Units

Prerequisites: None

2 hours lecture, 3 hours laboratory weekly

Construction of systems necessary to development of park sites--concrete block-wall, brick, watering systems and carpentry. Use of tools required. (Co-number Hort 5)

Baccalaureate Level

HORT 1 - INTRODUCTION TO HORTICULTURE

3 Units

Prerequisites: None

2 hours lecture, 3 hours laboratory weekly

The landscape industry in California; the wholesale grower, the jobs, the retail nursery, the garden center and other outlets for landscape plants and materials. A study of nursery location, organization and operation. Practice in production of ornamental plants.

Equivalent to OH 100, Cal Poly SLO

HORT 2 - PLANT STRUCTURE

3 Units

Prerequisite: None
2 hours lecture, 3 hours laboratory weekly

Introduction to plant structure with emphasis on roots, stems, leaves, flowers, fruits, seeds and inflorescences. Gross structure is emphasized rather than microscopic analysis and the objective is to prepare the student for courses in plant propagation and plant identification.
Accepted for credit at Cal Poly SLO

HORT 3 - PLANT PROPAGATION

3 Units

Prerequisite: Hort 2 or consent of instructor
2 hours lecture, 3 hours laboratory weekly

Production of ornamental trees, shrubs, vines and ground-covers by cuttings, budding, grafting, layerage, separation and division; lining out, balling, bare rooting, canning, growing of cutting material, growing liners; pruning and training espaliers, specimen plant production.
Equivalent to OH 233, Cal Poly SLO

HORT 4 - PLANT IDENTIFICATION

4 Units

Prerequisite: Hort 2 or Bio 2A or Bot 1
3 hours lecture, 3 hours laboratory weekly

Identification, habits of growth, culture of native plants and landscape use of ornamental trees, shrubs, vines, annuals, herbaceous perennials including tropicals, subtropicals, and house plants.
Equivalent to OH 122, Cal Poly SLO

HORT 5 - LANDSCAPE CONSTRUCTION & MAINTENANCE

3 Units

Prerequisite: Hort 1
2 hours lecture, 3 hours laboratory weekly

Pruning and maintenance of landscape shrubs and trees. Design and maintenance of landscape watering systems. Construction of concrete block, brick and wood walls and walks. (Co-Number For 5)
Equivalent to AE 121-122, Cal Poly SLO

HORT 6 - LANDSCAPE DESIGN

3 Units

Prerequisites: Hort 1, Hort 2, Hort 4
2 hours lecture, 3 hours laboratory weekly

Basic drafting techniques needed in landscape designing. Use of plant materials in the landscape design. Basic landscape design principles.
With LH 24 - equivalent to OH 223, Cal Poly SLO

HORT 7 - NURSERY PRACTICE

3 Units

Prerequisites: Hort 1, Hort 2
2 hours lecture, 3 hours laboratory weekly

Forcing of flowering plants. Citrus and avocado propagation. Cost analysis of basic nursery practices. (S)
Equivalent to OH 121, Cal Poly SLO

HORT 23A - ORGANIC POLYCULTURE

3 Units

Prerequisites: None
1 hour lecture, 6 hours laboratory weekly

Involves the information necessary to plant and develop an organic garden. Study of soils, organic fertilizers, raised bed planting and other facets of organic gardening. (F)

HORT 23B - ORGANIC POLY CULTURE

3 Units

Prerequisites: Hort 23A and/or consent of instructor
1 hour lecture, 6 hours laboratory weekly

A continuation of Hort 23A and an introduction to warm season crops. The course deals with the use of structurally and genetically diverse plants and animals in setting up and maintaining a complex ecosystem for organic polyculture farming.
(S)

LH 23 - LANDSCAPE GARDENING AND MANAGEMENT

3 Units

Prerequisite: None
3 hours lecture weekly

Planting and care of lawns, ground covers, flowers, trees and shrubs, including proper pruning and training; plant growth, weed, insect, and disease control; irrigation and fertilization principles; identification and uses of landscape plants; garden maintenance problems of landscape properties, with field laboratory in proper care and use of garden equipment. This is primarily an evening course.
Equivalent to OH 126, Cal Poly SLO
Parallels Env. Hort 10, UC Davis

LH 24 - LANDSCAPE DESIGN FOR HOMES

3 Units

Prerequisites: None
3 hours lecture weekly

Principles of landscape planning and design for residential properties, with emphasis on the location of lawns, trees, shrubs, walks, driveways, patios, planters, and other landscape structures for home and commercial landscaping; laboratory in practical drafting and landscaping design problems. This is primarily an evening course.
Equivalent to OH 223, Cal Poly SLO

LH 25A/B - TURFGRASS MANAGEMENT

3-3 Units

Prerequisites: None for 25A. 25A for 25B
3 hours lecture weekly

LH 25A - Study of turfgrass, including varieties, their selection and use in lawns, public parks, public institutions, playgrounds, athletic fields, golf courses, and bowling greens. Identification of turfgrass, establishment of turf areas, soil preparation, irrigation, fertilization and special management factors. This is primarily an evening course.

LH 25B - Study of the following topics: equipment used with turfgrass management; soil aeration and thatch control; drainage requirements and the use of wetting agents; sprinkler system design and operation; record keeping; personnel management; public relations. This is primarily an evening course.
Equivalent to OH 333, Cal Poly SLO

LH 26 - GARDEN INSECTS AND DISEASES AND THEIR CONTROL

3 Units

Prerequisites: None
3 hours lecture weekly

Study of the common garden insects and diseases. How to identify and how to control will be emphasized; also emphasis will be placed on biological controls where applicable. This course is designed for professional gardeners and home gardeners who desire a more thorough knowledge of the common garden insects and diseases found in Southern California. Primarily an evening course.
Equivalent to OH 327, Cal Poly SLO

LH 27 - PLANT PROPAGATION**3 Units**Prerequisites: None
3 hours lecture weekly

Propagation of plant materials through seeds, cuttings, budding, grafting, division and air layering. An evening course primarily designed for homeowners.

For information regarding Work Experience credit in the Agriculture program, refer to Page 224 in this catalog.

anthropology

Faculty: Norman Alger, Robert Lopez, Karla Rolff

Anthropology is the study of man and his learned social behavior--his culture. Anthropology attempts to study all men at all times. The broadness of this approach to human behavior has made it necessary to divide the study of anthropology into the four interrelated subdisciplines of cultural anthropology, physical anthropology, anthropological linguistics and archaeology. The majority of anthropologists are employed in teaching or research in universities or colleges. However, there are also opportunities for employment in various government jobs or in museums. Graduate school training is a normal prerequisite for professional work in anthropology.

REQUIRED COURSES IN THE MAJOR**University of California, Santa Barbara****CULTURAL EMPHASIS**Anth 1 Physical Anthropology
Anth 2 Cultural Anthropology**PHYSICAL EMPHASIS**Anth 1 Physical Anthropology
Anth 2 Cultural Anthropology
An 1 General Human Anatomy
Phys 1 Introduction to Human Physiology**California State University, Northridge**Anth 1 Physical Anthropology
Anth 2 Cultural Anthropology

Choose TWO courses from the following:

Afro-American Studies	History
Biology	Mexican-American Studies
Economics	Political Science
Geography	Psychology
Geology	Sociology

courses in anthropology

Anth 1 - PHYSICAL ANTHROPOLOGY**3 Units**Prerequisite: Satisfactory score on placement test.
3 hours lecture weekly

Human biology and physical anthropology; facts and problems of human evolution; primatology; the origin and antiquity of man; fossil man; human variation; the biological background of culture; human biological-cultural adaptation. (F, S)

Equivalent to Anthro 203, CSUN

Accepted for credit, UC (all branches)

Anth 2 - CULTURAL ANTHROPOLOGY

3 Units

Prerequisite: Satisfactory score on placement test.
3 hours lecture weekly

An understanding of man and his society with reference to the development and change of cultures; basic concepts and methods for analyzing society and culture illustrated with materials drawn largely from non-western societies. (F,S)

Equivalent to Anthro 204, CSUN
Accepted for credit, UC (all branches)
Equivalent to Ant 201, Cal Poly SLO

Anth 3 - ARCHAEOLOGY

3 Units

Prerequisites: Satisfactory score on placement test.
3 hours lecture weekly

Historical development, theory and techniques of archaeology. The study of Prehistoric cultures as revealed through the excavation and analysis of their material remains. Selected topics in the archaeology of both the New and the Old World. (F, S)

Accepted for credit, UC (all branches)

Anth 4 - MEXICAN-AMERICAN CULTURE

3 Units

Prerequisites: Satisfactory score on placement test or consent of instructor
3 hours lecture weekly

The social and cultural heritage of the Mexican-American, emphasizing middle American Civilizations, and including the evolution of the Mexican-American from the Spanish conquest to present day America. The course is concerned with the contributions made by the Mexican-Americans to the United States, especially in the fine arts, literature, and orally transmitted heritage. (This course will count for elective credit in the Humanities area.) (F,S) (Co-numbered MAS 2)

Equivalent to Chicano Studies 100, CSUN
Accepted for credit, UC (all branches)

Anth 5A/B - ARCHAEOLOGICAL FIELD METHODS

3-3 Units

Prerequisites: Anth 3 or concurrent enrollment in Anth 3, or consent of instructor.
1 hour lecture and 6 hours laboratory weekly, Saturdays

A course in practical archaeology for the student who desires to expand his existing knowledge of archaeology field work. The emphasis in this course will be on actual site excavation and laboratory analysis.

Accepted for credit, CSUN
Accepted for credit, UC (all branches)

Anth 6 - FIELD STUDIES IN PHYSICAL ANTHROPOLOGY

3 Units

Prerequisites: Anth 1 and consent of instructor
2 hours lecture and 3 hours laboratory weekly

Training in field problems in physical anthropology. Studies will be made on skeletal populations excavated from the local area or on living populations. A course in practical physical anthropology.

Accepted for credit, CSUN
Accepted for credit, UC (all branches)

Anth 22A/B - DIRECTED STUDIES IN ANTHROPOLOGY

1-3/1-3 Units

Prerequisites: A course in the specific field and the consent of the instructor and Division Chairman
1-3 hours tutorial weekly

Designed for selected students who are interested in furthering their knowledge of Anthropology on an independent study basis. Assigned problems will involve library, laboratory and field work. Maximum of 3 units.
Accepted for credit, CSUN: max. 3 units

Anth 7 - PEOPLES AND CULTURES OF THE WORLD

3 Units

Prerequisites: Satisfactory score on placement test
3 hours lecture weekly

An in-depth study of selected peoples and cultures from major culture areas of all continents. Emphasis will be on traditional cultures and changes induced by contact with the greater world.
Accepted for credit, CSUN

art

Faculty: Kirk Aiken, Department Head; William Dodgen, John Gray, Jack Noyes
Frank Sardisco, Delmore Scott, James Sturgeon

For the student who is interested in art as a career, this curriculum will prepare him for advanced work in an art school, or for further intensive work in the field of his choice. If the student plans to transfer to a university he should consult the catalog of that university for requirements.



REQUIRED COURSES IN THE MAJOR

California State University, Northridge		University of California, Santa Barbara	
Art 1A/1B	Art History	Art 1A/1B	Art History
Art 4A/4B/4C	Color and Design	Art 4A/4B/4C	Color and Design
Art 12 A/12B	Drawing & Comp.	Art 12A/12B	Drawing & Comp.
Art 19A	Sculpture (Fine Arts or Crafts option)	Art 16A/16B	Painting
Art 16A/16B	Painting (Fine Arts Option)	Art 19A	Sculpture
Art 8A	Ceramics (Ceramics Option)	For Lan	Foreign Language (3 semesters or 5 quarters)
Photo 1A	Beginning Photography (Design Option)		

commercial art/applied design

The Commercial Art Major is designed to provide the versatility and capabilities needed to solve the design problems of contemporary society whether the need be in business, education, urban planning or environmental design. Students enrolled as Commercial Art Majors, upon completion, will have a thorough understanding of reproduction processes and skills in a variety of media including painting, drawing, 3-dimensional media, photography, lithography and tele-communication. Job opportunities include Graphic Designer, Paste-up Artist and Catalog and Publications Design.

SEQUENCE OF REQUIRED COURSES

First Semester

Art 4A	Color and Design
Art 12A	Drawing & Composition
Art 19A	Sculpture
Broad 1/Journ 1	Mass Communications

Third Semester

Art 1A	Art History
Art 13A	Life Drawing
Art 41	Lettering and Typography
Photo 1A	Beginning Photography

Third and Fourth Semester Options

Art 40	Commercial Design
Art 43	Perspective and Rendering
Art 44	Product Design
Art 45	Fashion Illustration

Second Semester

Art 4B	Color & Design
Art 12B	Drawing & Composition
Art 19B	Sculpture
Art 44	Product Design
CA 4	Layout and Design

Fourth Semester

Art 1B	Art History
Art 42	Advertising Design
Cine 1	History of the Motion Picture

Art 46	Presentation Graphics
Art 22A/B	Directed Studies
Cine 2A	Art & Techniques of Film

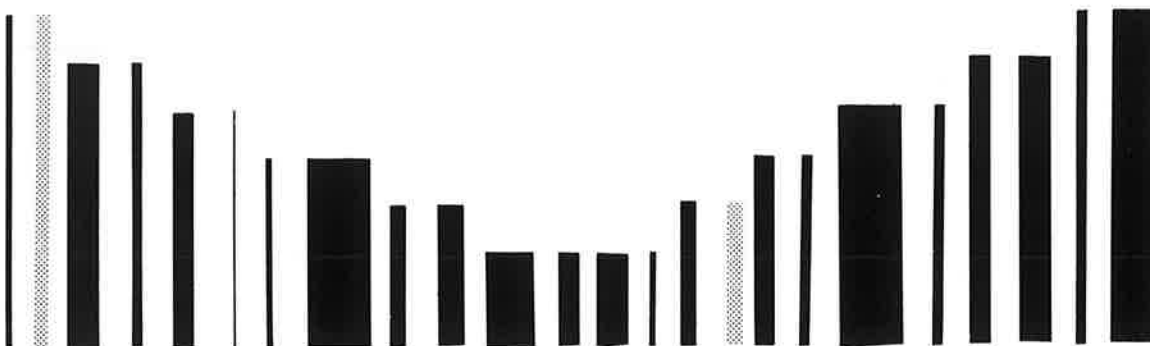

courses in art

Art 1A - ART HISTORY

3 Units

Prerequisite: Satisfactory score on placement test.
3 hours lecture weekly.

Survey of the history of art of the western world from prehistoric times to the middle ages, including ancient, medieval, classic, early Christian and Byzantine. Emphasis on techniques in architecture, painting and sculpture as well as an examination of the key figures in art history.

Equivalent to Art 111A, CSUN

Accepted for credit, UC (all branches)

Art 1B - ART HISTORY

3 Units

Prerequisite: Satisfactory score on placement test.
3 hours lecture weekly.

Survey of the history of art of the western world from the middle ages to modern times; continued emphasis on techniques of producing art as well as an examination of the key figures in art history.

Equivalent to Art 111B, CSUN

Accepted for credit, UC (all branches)

Art 2 - ART APPRECIATION

3 Units

Prerequisite: Satisfactory placement score
3 hours lecture weekly

A one-semester survey to acquaint the student with the major periods and styles of art of the western world and to develop understanding of the visual arts. (Also see Humanities 6)

Recommended for general education requirement. (F,S)

Equivalent to Art 105, CSUN

Accepted for credit, UC (all branches)

Art 3 - MODERN ART FORMS

3 Units

Prerequisite: Art 2
3 hours lecture weekly

Modern art forms builds upon the foundation of art appreciation to investigate many of the movements, events and personalities of twentieth-century painting, sculpture and architecture. Special emphasis is placed on current developments and exhibitions.

Accepted for credit, UC (all branches)

Accepted for credit, CSUN

Art 4A/B/C - COLOR AND DESIGN

2-2-2 Units

Prerequisites: Art 4A for Art 4B; Art 4B for Art 4C
or permission of instructor
1 hour lecture, 3 hours studio weekly

Art 4A: A basic course providing background in the use of design principles; specific problems in line, shape, texture and form. Emphasis on color theory and its practical applications. (F)

Equivalent to Art 140A, CSUN

Accepted for credit, UC (all branches)

Art 4B: The study of color and design as it is used in the art of painting. Methods of employing these ingredients are also considered in many of the fields, including commercial usage. (S)

Equivalent to Art 140B, CSUN

Accepted for credit, UC (all branches)

Art 4C: The use of various materials such as wood, metal, cardboard, plaster, weights to form aesthetic designs in actual space rather than simulated pictorial space. (F)

Equivalent to Art 240, CSUN

Accepted for credit, UC (all branches)

Art 7 - APPLIED COLOR AND DESIGN

2 Units

Prerequisites: Consent of Instructor

6 hours laboratory weekly

Study of art forms with stress on an architectural form, interior design, crafts, etc.; creative art experience in various media. Not designed for art majors. (SUMMER ONLY)

Accepted for credit, UC (all branches)

Art 8A/B - BEGINNING CERAMICS

2-2 Units

Prerequisites: None for 8A; 8A for 8B

6 hours laboratory weekly

Practice in the technique of elementary clay construction including coil, slab method, and introduction to throwing on the potter's wheel; experimentation in sculptural forms and the development of glazes. \$15 fee for tools and clay.

8A-Equivalent to Art 267, CSUN

Accepted for credit, UC (all branches)

8B-Accepted for credit, CSUN

Accepted for credit, UC (all branches)

Art 12A/B - DRAWING AND COMPOSITION

2-2 Units

Prerequisites: None for Art 12A; Art 12A for Art 12B

6 hours studio weekly.

Art 12A: The first semester emphasizes the drawing of basic forms such as still life and fundamental shapes.

Equivalent to Art 124A, CSUN

Accepted for credit, UC (all branches)

Art 12B: Original problems and experimental design including the human figure. Particular emphasis upon the fundamental means of pictorial composition.

Equivalent to Art 124B, CSUN

Accepted for credit, UC (all branches)

Art 9A/B - CERAMIC DESIGN

2-2 Units

Prerequisites: Art 8A, Art 8B and Art 4A

6 hours laboratory weekly

An advanced study in ceramics with emphasis on exploration of clay bodies, glaze materials, glaze calculations, firing, and independent projects. This course is designed to develop growth and individual creative expression.

Accepted for credit, CSUN

Art 13A/B - LIFE DRAWING

2-2 Units

Prerequisite: Art 12A for Art 13A; Art 13A for Art 13B

or permission of instructor.

6 hours studio weekly

Art 13A: Drawing the human figure, beginning with skeletal structure, using many media including charcoal, pencil, pen and ink, conte crayon, and pastels. Emphasis on structure, proportion, form and composition; practice in the use of linear and tonal concepts. (F)

Equivalent to Art 230, CSUN

Accepted for credit, UC (all branches)

Art 13B: Drawing the human figure from the live model; freedom of expression, (S)

Accepted for credit, CSUN

Accepted for credit, UC (all branches)

Art 15A/B - BEGINNING PRINTMAKING

2-2 Units

Prerequisites: Art 4A

6 hours studio weekly

Exploration of the printmaking media available to the artist. Work will include relief (wood block and linocut) as well as intaglio (etching, engraving, agatint, etc.)

15A - Equivalent to Art 237, CSUN

15B - Accepted for credit, CSUN

Art 16A/B - PAINTING

2-2 Units

Prerequisites: Art 4B and Art 12B or consent of instructor;

Art 16A for Art 16B

6 hours studio weekly

Art 16A: An intermediate course pertaining to the nature of structural and expressive values in contemporary painting; practice in the building for form, control of pictorial order, and the uses of color and light. (F)

Equivalent to Art 227A, CSUN

Accepted for credit, UC (all branches)

Art 16B: Emphasis on technical competence and individual concepts; experimentation with traditional and newer painting materials. (S)

Equivalent to Art 227B, CSUN

Accepted for credit, UC (all branches)

Art 17 - LANDSCAPE PAINTING

2 Units

Prerequisites: Art 4A/B or Art 12A/B; or permission of instructor

6 hours studio weekly.

Painting from nature out of doors in various media, such as acrylics, oils, water color, and pastels.

Accepted for credit, CSUN

Accepted for credit, UC (all branches)

Art 18A/B - WATER COLOR

2-2 Units

Prerequisites: Art 4A, Art 12A

6 hours studio weekly

An exploration of the water color medium, emphasizing the development of a personal fluid painting style in both abstract and realistic subject matter.

Accepted for credit, CSUN

Art 19A/B - SCULPTURE

2-2 Units

Prerequisites: None for 19A; 19A for 19B

6 hours studio weekly.

19A - A studio course in the fundamentals of sculpture, exploring historical and aesthetic aspects of sculpture in conjunction with practical project experience.

Media: cardboard, clay, plaster, wood, wire, metal and plastics.

Equivalent to Art 235, CSUN

Accepted for credit, UC (all branches)

19B - Advanced problems in sculptural forms with emphasis on individual projects, evaluation, growth, and direction. Media: same as 19A and other media with consent of the instructor.

Accepted for credit, UC (all branches)

Art 20 - TWENTIETH CENTURY ART**3 Units**

Prerequisites: Satisfactory score on Placement Test.
3 hours lecture weekly

Survey of major art movements and personalities of the Twentieth Century from the post-impressionists, through the isms of the first fifty years into the conceptual art of the seventies.

Art 21A/B - ADVANCED SCULPTURE**3-3 Units**

Prerequisites: Art 4A/B/C, Art 12A/B, Art 19A/B
1 hour lecture, 6 hours laboratory weekly

Opportunity to explore the physical characteristics of selected materials and processes used in sculpture. Independent research and projects are employed. A further study in sculpture media (clay, plaster, welding, wood, and stone) and their aesthetic concepts.

Art 22A/B - DIRECTED STUDIES IN ART**1-3/1-3 Units**

Prerequisites: A course in the specific field and the consent of the instructor and Division Chairman.
1-3 hours tutorial weekly.

Designed for selected students who are interested in furthering their knowledge of art on an independent study basis. Assigned problems will involve library, laboratory, and field work. Maximum of 6 units. (F,S)
Max 3 units credit, CSUN
Accepted for credit, UC (all branches)

Art 40 - COMMERCIAL DESIGN**3 Units**

Prerequisites: Art 4A/B, Art 12A/B or consent of instructor
2 hours lecture, 3 hours laboratory weekly

Emphasis on typographic design and experimental media as they affect Graphic Communications. Includes logotype concepts, letterheads, poster design, book jackets, magazine and book layouts.
Equivalent to GRC 104, Cal Poly SLO

Art 41 - LETTERING AND TYPOGRAPHY**2 Units**

Prerequisites: Art 4A/B, Art 12A/B or consent of instructor
1 hour lecture, 3 hours laboratory weekly

Basic lettering with pen and brush, constructed letters in gothic, Roman, Italic, Script, Text and Modern Type faces. Emphasis on essentials underlying character form and distribution on the pages for layouts.
Baccalaureate Level

Art 42 - ADVERTISING DESIGN**2 Units**

Prerequisites: Art 4A/B; Art 12A/B or consent of instructor
1 hour lecture, 3 hours laboratory weekly

Experiences in rendering, lettering, type specifications and figure indication which lead into advertisement layouts and their translation into pasteup and camera-ready art. Comprehensive presentations; flat ads; packaging; point-of-sale displays; development of a photographic unit.

Art 43 - PERSPECTIVE AND RENDERING**2 Units**

Prerequisites: Eligibility for English 1 or consent of instructor
1 hour lecture, 3 hours laboratory weekly

Study of one-, two-, and three-point black and white perspective drawing of objects; shading; free-hand sketching; and rendering. Media shall include pen and pencil.

Art 44 - PRODUCT DESIGN**3 Units**

Prerequisites: Art 4A or Art 8 or consent of the instructor upon presentation of suitable portfolio.
2 hours lecture, 3 hours laboratory weekly

Form and mass as applied to simple product design problems. Re-design of consumer products. Using surface development and model making skills, students carry the problem of designing tools, small household appliances, office and industrial equipment, from idea sketches to working drawings and finished scale models. Examination of manufacturing methods, material limitations. Emphasis on appearance and function.

Art 45 - FASHION ILLUSTRATION**2 Units**

Prerequisites: Art 13 or consent of instructor upon presentation of suitable portfolio.
6 hours laboratory weekly

Analysis of the contemporary figure for style, clothing and implied movement. Elegance, poise, dignity and mood. Wash drawing and dry media for newspaper and magazine layout.

Art 46 - PRESENTATION GRAPHICS**2 Units**

Prerequisites: Art 4A or consent of instructor upon presentation of suitable portfolio.
6 hours laboratory weekly

Utilization of media for presentation materials for Commission and City Council consideration. Students will prepare flip charts, graphs, over-head projection transparencies and slide presentations.

For information regarding Work Experience credit in the Art program, refer to Page 224 in this catalog.

aviation training

AT 1 - AVIATION GROUND SCHOOL**3 Units**

Prerequisites: None
3 hours lecture weekly

Basic Ground School approved by Federal Aviation Administration, designed to prepare the student for FAA private pilot examination.

behavioral sciences

BSc 1 - INTRODUCTION TO THE BEHAVIORAL SCIENCES**6 Units**

Prerequisites: Satisfactory score on placement test
6 hours lecture weekly

An interdisciplinary approach to the study of the subject matter of psychology and sociology. A course designed to introduce the non-major student in psychology and sociology to these behavioral sciences in such a way as to compare and contrast the two disciplines. A course created to explore the motives, emotions, perceptions, attitudes, personality and intellectual development of the human being (3 units Psych 2 and 3 units of Soc 1)
Baccalaureate Level

BSc 2 - INTERPERSONAL BEHAVIOR

6 Units

Prerequisites: Behavioral Science 1; or Soc 1 or Psych 1A or Psych 2

6 hours lecture weekly

A study of the overlapping portions of psychology and sociology which is concerned with describing, explaining and understanding human relationships, social adaptability, and the modification of the individual through interaction with others. Topics of study include small group formation, group dynamics, attitude formation and change, leadership, power, social perception, social determinants of personality, group processes in education and mental health and specific social problems. (3 units Psych 3 and 3 units Psych 5 or Soc 5)
Baccalaureate Level



biological sciences

Faculty: David Bishop, William Brisby, Richard Gilman,
Larry Miller, Jack Reynolds, Department Head; Carol Snyder.

biology

The word "biology" is from two Greek words meaning "life" and "science"— or the science of life. Thus, the biologist is concerned with the world of living things— men and microbes, wild and domestic animals, plants and insects, birds and fish. Some scientists in this field conduct research to expand our knowledge about living organisms; others teach in colleges and universities and also conduct research. Still others apply biological knowledge to the solution of practical problems in drug research, agriculture, and conservation. Graduates also find satisfying employment in fisheries, forestry, wildlife management, food processing, public health, fermentation, and medical research.

REQUIRED COURSES IN THE MAJOR

California State University, Northridge

Biol 2A/B	General Biology
Math 15	Intro Statistics
Chem 1A/B	General Chemistry
Chem 7A/B	Organic Chemistry
Ph 2A/B	General Physics

University of California, Santa Barbara

Biol 2A/B	General Biology
Chem 1A/B	General Chemistry
Chem 7A/B	Organic Chemistry
Math 16A/B	Applied Calculus
Ph 2A/B	General Physics
For Lan	Foreign Language

physical therapy

Physical Therapists help persons with muscle, nerve, joint, or bone diseases or injuries to overcome their disabilities. A student majoring in physical therapy may anticipate employment in a doctor's office, in a public or private hospital, in a clinic, or he may have a private practice of his own. Opportunities may also be found in public agencies, governmental services, and in industrial applications.

REQUIRED COURSES IN THE MAJOR

University of California, Los Angeles

Chem 1A/B	General Chemistry
Biol 2A/B	General Biology
Phys 1	Intro to Physiology
An 1	General Human Anatomy
Ph 2A/B	General Physics
Math 7	College Alg./Trig
For Lan	Foreign Language

dental

Most graduates of the dental curriculum enter the field of general practice. However, today more and more dentists are entering the field of public health. Specialty fields such as oral surgery, orthodontics, and the control of dental disease offer opportunities for those interested and qualified in the additional work that will prepare them for those specialties.

REQUIRED COURSES IN THE MAJOR

University of California, Los Angeles

Chem 1A/B	General Chemistry
Chem 5	Quantitative Analysis
Chem 7A/B	Organic Chemistry
Biol 2A/B	General Biology
Math 16A	Applied Calculus

University of Southern California

Chem 1A/B	General Chemistry
Chem 5	Quantitative Analysis
Chem 7A/B	Organic Chemistry
Biol 2A/B	General Biology
Math 16A	Applied Calculus

dental hygiene

The major in dental hygiene prepares the student for work in a private dental office, in the field of public health, in public schools, in industrial clinics, in public and private hospitals, or as a research worker.

REQUIRED COURSES IN THE MAJOR

University of California, Los Angeles

Biol 2A/B	General Biology
Chem 1A/B	General Chemistry
Engl 1	Composition and Lit
Psych 2	General Psychology
For Lan	Foreign Language

medicine

The field of medicine has been considered for over three thousand years to be one of the humane arts. The curriculum leading to the degree of Doctor of Medicine provides the student with the means by which he may prepare himself for the demanding profession in which he is responsible for the care of patients; for the cure and prevention of illness; and for teaching and research. Graduates may elect further training for a choice of careers; special practice in surgery; pediatrics; psychiatry; academic medical; public health; and in industrial medicine.

REQUIRED COURSES IN THE MAJOR

University of California, Los Angeles

Chem 1A/B	General Chemistry
Chem 5	Quantitative Analysis
Chem 7A/B	Organic Chemistry
Biol 2A/B	General Biology
Math 16A	Applied Calculus

University of Southern California

Chem 1A/B	General Chemistry
Chem 5	Quantitative Analysis
Chem 7A/B	Organic Chemistry
Biol 2A/B	General Biology
Math 16A	Applied Calculus

wild animal training & management

The Wild Animal Behavior Program is a two-year program.

With the rapid development of recreational animal parks, ecologically oriented zoos, and animal entertainment centers, there has been a corresponding need for trained and experienced personnel to work with these animals. This major has been developed for those who are interested and qualified to work as animal handlers and eventually as professional trainers. The individual who pursues this course of study will be trained in working with wild or exotic animals, as well as obtaining a background of knowledge in related fields which he may eventually use in developing his own show or facility.

Applications for this program may be obtained in the Counseling Office.

REQUIRED COURSES IN THE MAJOR

Bio 1	Principles of Biology
Bio 4A	Wild Animal Behavior I
Bio 4B	Wild Animal Behavior II
Bio 5A/B	Wild Animal Training
Zoo 3A/B	Vertebrate Natural History
Bio 49A/B	Directed Work Experience
Psych 2	General Psychology
Art 4A	Color & Design
ThA 3	Voice and Diction
ThA 20	Theatre Production
Bus 29	Intro to Bus and Econ
Bus 32	Small Business Management

veterinary medicine

Career opportunities are many and varied for those trained to alleviate and prevent diseases in animals. Caring for the nation's animals attracts the majority of the graduates into private practice. However, fields such as teaching, research, government service, space medicine, public health, bio-medical research, laboratory animal medicine, and drug research are attracting more and more of those trained in veterinary medicine.

REQUIRED COURSES IN THE MAJOR

California State College, Davis

Chem 1A/B	General Chemistry
Chem 7A/B	Organic Chemistry
Chem 5	Quantitative Analysis
Ph 2A/B	General Physics
Biol 2A/B	General Biology
AH 1	Intro. Animal Husbandry

courses in biological sciences

An 1 - GENERAL HUMAN ANATOMY

4 Units

Prerequisite: Bio 1 or Bio 2A or equivalent
2 hours lecture, 6 hours laboratory weekly

The functional anatomy of human organs and organ systems with some histological studies, using non-human mammals for dissection, but with emphasis on the human structure and demonstrations on cadaver.

Equivalent to Biology 211, 212, CSUN
Accepted for credit, UC (all branches)

Biol 1 - PRINCIPLES OF BIOLOGY

4 Units

Prerequisites: Satisfactory score on placement test
3 hours lecture, 3 hours laboratory weekly

Introductory biology for students not majoring in the natural sciences. Emphasis on basic concepts, especially genetics, evolution and ecology. Particular attention will be given to the implications of biological ideas in human affairs. (F)

Equivalent to Biol 100, CSUN
Accepted for credit, UC (all branches)

Biol 2A/B - GENERAL BIOLOGY

4-4 Units

Prerequisites: Satisfactory score on placement test. Biol 2A for 2B.
Chem 1A is recommended and can be taken concurrently.
3 hours lecture and 3 hours laboratory weekly.

This is a full year course for those wishing two semesters of biology, and for the science and preprofessional majors.

Biol 2A - This course surveys the major plant and animal groups, and covers the origin of life, cell structure and function, bio-energetics and physiological processes (especially in vascular plants and vertebrate animals).

Equivalent to Biology 150, 150L, CSUN
Accepted for credit, UC (all branches)

Biol 2B - This course continues physiological processes in organisms and considers the areas of classical and molecular genetics, embryology, evolution, ecology and behavior.

Equivalent to Biology 151, 151L, CSUN
Accepted for credit, UC (all branches)

Biol 3A/B - MARINE BIOLOGY

4-4 Units

Prerequisites: Biol 1 or 2A for 3A, 3A for 3B
3 hours lecture, 3 hours laboratory weekly

Biol 3A - Lecture and laboratory course with emphasis upon physical oceanography and the invertebrate life forms in the marine environment.

Biol 3B - An ecological study of marine organisms with emphasis on the higher forms of marine life. A study of the vocational and avocational utilization of the oceans with emphasis on man's effect upon the marine environment.
Accepted for credit, CSUN
Accepted for credit, UC (all branches)

Biol 4A - WILD ANIMAL BEHAVIOR I

3 Units

Prerequisites: One semester of Biology and one semester of Psychology. Consent of instructor.
2 hours lecture, 3 hours laboratory weekly

An introduction to wild animal behavior for those interested in working professionally in the field of wild animal training and research. Lectures will be held at Africa USA in Fillmore.

Biol 4B - WILD ANIMAL BEHAVIOR II

3 Units

Prerequisites: Biol 4A and consent of the instructor
3 hours lecture weekly

This course deals with the fundamentals of operant conditioning as it applies to the professional animal training field. The second half consists of elementary veterinary procedures that students should understand in working with wild animals.

Biol 5A/B - ANIMAL TRAINING

4-4 Units

Prerequisites: Biology 4A and consent of instructor
1 hour lecture, 9 hours laboratory weekly

Students will proceed with the application of techniques observed in Biol 4A. Each student will train an animal or animals for possible exhibition. Proper care of animal in all respects will be emphasized.

Biol 10 - SEASHORE LIFE

2 Units

Prerequisites: None
1 hour lecture, 3 hours laboratory weekly

An overview of the marine environment of Southern California with the study of the distribution and zonation of common seashore plants and animals.
Accepted for credit, CSUN
Accepted for credit, UC (all branches)

Biol 12 - PARAMEDICAL BIOLOGY**3 Units**

Prerequisites: None
3 hours lecture weekly

This course is designed to prepare those students desiring to take anatomy, microbiology and physiology but who do not need biology credit for admittance to nursing and health science schools. Material covered will be basic biology and terminology pertinent to future enrollment in the advanced courses. This course is not transferable nor does it count for lab science credit.

Biol 14 - NATURAL HISTORY OF THE CONEJO**3 Units**

Prerequisites: None
3 hours lecture - walking weekly

A study of the natural features, animals and plants of the Conejo Valley. The local ecological communities are visited and described. Some attention is given to cultivated areas. The course may be given in other areas from time to time with a change in the title to indicate the location of the study.
Accepted for credit, CSUN

Biol 22A/B - DIRECTED STUDIES IN BIOLOGY**1-3/1-3 Units**

Prerequisite: A course in the specific field with a recommending grade and consent of instructor and Division Chairman.
1-3 hours tutorial weekly

Designed for selected students who are interested in furthering their knowledge of biology on an independent study basis. Assigned problems will involve library, laboratory, and field work. Maximum of 6 units.
Accepted for credit, CSUN, 3 units maximum
Accepted for credit, UC (all branches)

Bot 1 - GENERAL BOTANY**5 Units**

Prerequisite: Satisfactory score on placement test.
3 hours lecture, 6 hours laboratory weekly

Introductory study of morphology, anatomy and physiology of seed plants; emphasis on such biological principles as physical and chemical aspects of life, cellular organization, reproduction, and heredity. (F)
Accepted for credit, CSUN
Accepted for credit, UC (all branches)

Bot 3 A/B - PLANT IDENTIFICATION**2-2 Units**

Prerequisites: One semester of Biology
1 hour lecture, 3 hours laboratory weekly

A field course in the identification of plants. The fall semester deals with trees and fall flowers. The spring semester deals with ferns and spring flowers. A basic part of the course concerns the principles of taxonomy. Local natural biotic communities are studied together with the horticultural species, both native and exotic.

Accepted for credit, CSUN
Accepted for credit, UC (all campuses)

Bot 4 A/B - BOTANY WORKSHOP**2-2 Units**

Prerequisites: Consent of instructor
1 hour lecture, 3 hours laboratory weekly

Qualified students are assigned to community projects requiring botanical knowledge. Instruction and actual practice will include all phases of work in a botanic garden.

Micro 1 - PRINCIPLES OF MICROBIOLOGY**5 Units**

Prerequisites: Chem 12, and Biol 2A or Biol 12
(concurrent enrollment is acceptable).
3 hours lecture, 6 hours laboratory weekly

Bacteria, algae, fungi, Rickettsiae, viruses and protozoa; emphasis on bacterial morphology, anatomy, staining, classification, metabolism and growth, and effects of physical and chemical agents on bacteria; applied microbiology with some emphasis on pathogenic forms and immunity.

Equivalent to Biology 215, CSUN
Accepted for credit, UC (all branches)

Phys 1 - INTRODUCTION TO HUMAN PHYSIOLOGY**4 Units**

Prerequisites: Chem 12 or equivalent and Biol 2A
3 hours lecture, 3 hours laboratory weekly

Functioning of the human organism; consideration of organ systems and basic structure as necessary to understand the physiological principle involved; laboratory experiments and/or demonstrations to illustrate basic physiological principles, techniques and instruments.

Equivalent to Biology 281, 282, CSUN
Accepted for credit, UC (all branches)

Zoo 3 A/B - VERTEBRATE NATURAL HISTORY**2-2 Units**

Prerequisites: One semester of biology or consent of instructor
1 hour lecture, 3 hours laboratory weekly

Studies of local vertebrates (excluding fishes) in the field. Lectures will emphasize taxonomy and special adaptations of birds, mammals, reptiles and amphibians. Laboratory will emphasize identification and ecological relationships. Migratory birds and mammals will be covered in the fall and breeding birds, reptiles and amphibians will be covered in the spring.

Accepted for credit, CSUN

For information regarding Work Experience credit in the Biological Science program, refer to Page 224 in this catalog.





broadcasting

Faculty: Alfred Miller, Robert Reynolds, Richard Studebaker

There are ever increasing demands for personnel in the broadcasting industry. The Broadcasting program provides specific pre-employment training for students wishing to prepare for careers in radio and television. It also furnishes the necessary background for students who plan to seek a baccalaureate or higher degree in the broadcasting field in a senior college. Students may plan careers in any field that involves public information or public opinion.

REQUIRED COURSES IN THE MAJOR
Transfer Program

California State University, Northridge		University of California, Los Angeles	
Broad 1	Mass Communications	ThA 2A	Fundamentals of Acting
Broad 2	Broadcast Studio Operations	ThA 20A/B	Theatre Production
Journ 2	News Reporting	Engl 15A/B	English Literature
Broad 7	Radio Production Workshop		

REQUIRED COURSES IN THE MAJOR
A.A. Degree Program

Broad 1	Mass Communications
Broad 2	Broadcast Studio Operations
Broad 3	Television Production Workshop
Broad 4A	Television Directing
or	
Broad 4B	Remote Telecasting
Broad 5	Radio-Television Writing
Cine 1	History of the Motion Picture
Photo 1	Beginning Photography

courses in broadcasting

Broad 1 - MASS COMMUNICATIONS

3 Units

Prerequisites: None

3 hours lecture, 1 hour laboratory weekly

This course will acquaint the student with the origins, development and contemporary role of newspapers, magazines, cinema, radio, TV, and related fields such as advertising and public relations. Will survey the history and the application of mass communications. The course will also involve related critical and practical applications of this information. (Co-number Journ 1)

Equivalent to Journ 100, CSUN

Broad 2 - BROADCAST STUDIO OPERATION

3 Units

Prerequisites: Broad 1 or concurrent with Broad 1

2 hours lecture, 3 hours laboratory

A technical theory course in basic television circuits, cameras, control board, video-tape recorders, lighting, microphones, and overall television station operation. Some practical experience in the various aspects of production, explanation of program patterns, studio procedures, use of equipment, production of programs and radio-television acting.

Accepted for credit, CSUN

Broad 3 - TELEVISION PRODUCTION WORKSHOP

3 Units

Prerequisites: Broad 2

1 hour lecture, 6 hours laboratory weekly

This course involves intermediate work in production, camera work, technical direction, lighting, etc. The creation of new program concepts and types is stressed. Each student is responsible for producing his own half-hour experimental TV program. (F)

Equivalent to RTV 140, CSUN

Broad 4A - TELEVISION DIRECTING AND EDITING

3 Units

Prerequisites: Broad 2 and 3

1 hour lecture, 6 hours laboratory weekly

Advanced directing of special projects, experimental, and instructional television programs. Highest quality productions will be included in campus-wide instructional television guide for possible utilization by local cable television systems.

Baccalaureate Level

Broad 4B - REMOTE TELECASTING

3 Units

Prerequisites: Broad 2 and 3

1 hour lecture, 6 hours laboratory weekly

Students enrolled in this course will learn the practices and procedures involved in producing the telecast outside the studio. All work will be by arrangement and will involve producing, directing and crew work on actual productions including football and basketball games, speeches, concerts, dramas, and special events. Field trips are included to inspect major television remote equipment in operation.

Baccalaureate Level

Broad 5 - RADIO-TELEVISION WRITING

3 Units

Prerequisites: English 1A or consent of instructor

3 hours lecture weekly

This course deals with the preparation and analysis of dramatic scripts, program formats, public service announcements, local news, commercials, continuity, discussion programs, special events, talks and interviews. Training is given in the fundamentals of script format, professional methods, and the ethics and restrictions involved in broadcast media. (Co-number English 11). (S)

Accepted for credit, CSUN

Accepted for credit, UC (all branches)

Broad 6 A/B - FCC LICENSE REVIEW

3-3 Units

Prerequisites: None

3 hours lecture weekly.

This course will review basic electronics especially pertaining to broadcasting to prepare the student for the series of Federal Communications Commission examinations eventually leading to the FCC First Class Radiotelephone Operator's License. (Co-numbers: ET 6A/B, Journ 6A/B) (6A-F, 6B-S)

Accepted for credit, CSUN

Broad 7 - RADIO PRODUCTION WORKSHOP

3 Units

Prerequisites: Broad 1 or concurrent enrollment

2 hours lecture, 3 hours laboratory weekly

Class offers integrated work in various radio broadcasting functions. Included are announcing, acting, disc jockeying, basic writing, program direction, program production, advertising, radio interviewing, and station operations.

Equivalent to RTV 130, CSUN

Broad 8 - VOICE AND DICTION**3 Units**

Prerequisites: None
 3 hours lecture weekly

Individual speech improvement, instruction and practice in correct breathing, voice control and diction. The study of correct pronunciation, enunciation and voice production, including the study of dialects, foreign and regional. This course is designed for students in drama, forensics, broadcasting or education. (Co-number Speech 3, ThA 3)
 Equivalent to Drama 106, CSUN

Broad 9 - ACTING FOR FILM AND TV**3 Units**

Prerequisites: ThA 2A or equivalent, or permission of instructor
 2 hours lecture, 4 hours laboratory weekly

Learning the techniques required in acting before the camera. Includes terminology, blocking, movement, rapid line learning, etc., as it pertains to film and TV, and as it varies from stagework; microphone techniques and opportunities to work in student-directed films and television shows.
 (Co-numbered ThA 9)

Broad 22A/B - DIRECTED STUDIES IN BROADCASTING**1-3/1-3 Units**

Prerequisite: A course in the specific field and the consent of the instructor and Division Chairman
 1-3 hours tutorial weekly

Designed for selected students who are interested in furthering their knowledge of broadcasting on an independent study basis. Assigned problems will involve library, laboratory, and field work. Maximum of 6 units.

For information regarding Work Experience credit in the Broadcasting program, refer to Page 224 in this catalog.

business

Faculty: William Rodgers, Department Head; Kenneth Ainge, Sharon Biderman, Donald Bowen, Tanya Burke, Marjorie Corbell, William Dickneider, Peter Gucciardo, Richard Perry

business administration

A business administration program is designed to prepare students for eventual responsible executive positions in business and government. Training is provided also for those who wish to equip themselves for professional types of employment, such as business research and statistics, operations research, advertising, real estate appraisal, and business and economic consulting.

REQUIRED COURSES IN THE MAJOR**California State University, Northridge**

Econ 1A/B Principles of Economics
 Bus 1A/B Accounting Principles
 Bus 33A Business Law I
 Math 7 or College Alg./Trig.
 Math 12 or College Algebra w/Business Applications
 Math 16A Applied Calculus
 Math 25A or Calculus w/Analytic Geom I

CSU, San Jose

Econ 1A/B Principles of Economics
 Bus 1A/B Accounting Principles
 Bus 33A Business Law I
 Math 15 Introductory Statistics

business management

This program is designed to provide the student with job skills to permit him to serve in a business management position in business or industry. A student is assisted in permanent placement upon completion of the A.A. degree in Management.

REQUIRED COURSES IN THE MAJOR

Bus 29	Intro to Bus/Econ
or	
Bus 30*	Introduction to Business
Bus 37+	Marketing
Bus 31*	Business Organization and Management
Bus 39*	Business Communications
Bus 36	Merchandising
Bus 33A	Business Law I
Psych 3	Personal & Social Adjustment
Bus 50*	Elements of Supervision
Bus 44	Business Mathematics

RECOMMENDED COURSES FOR THE MAJOR

Bus 3*	Applied Accounting
DP 1+	Intro to Data Processing

*A student currently employed in the field may receive an In-Service Certificate in Business Management upon successful completion of the courses marked * and 6 additional units in General Education, for a total of 21 units.

+A student not currently employed in the field may receive a Pre-Service Certificate in Business Management upon successful completion of the courses marked * plus the courses marked + and 9 additional units in General Education, including 6 units of Hum 1A or Hum 1B, for a total of 30 units.

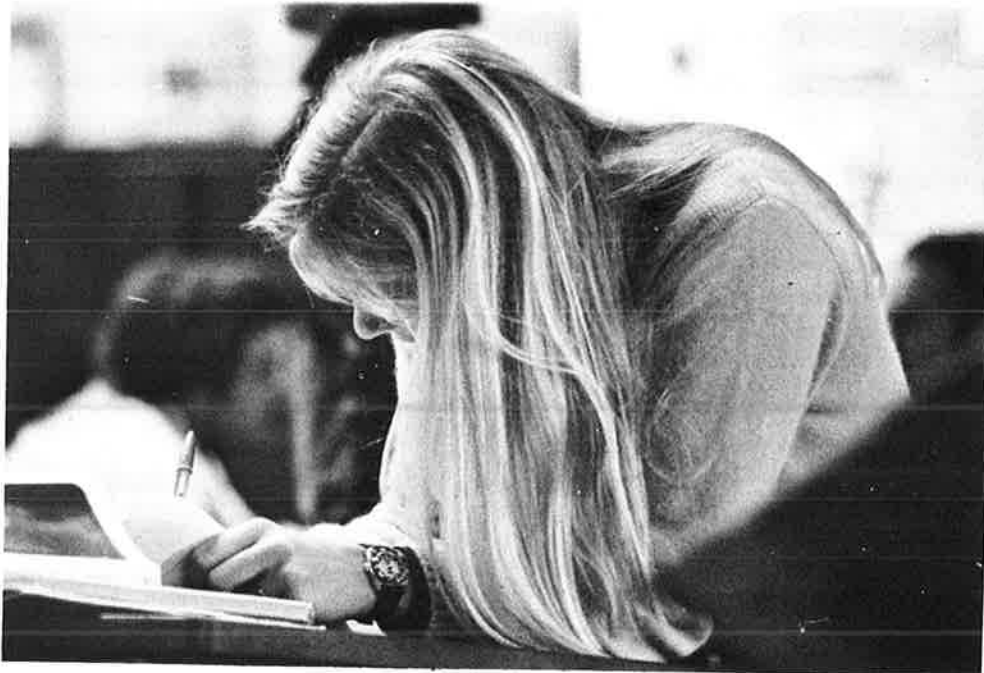

industrial supervision

This program is designed both for students wishing to enter into the industrial supervisory field and those now currently employed in an industry supervisory position. Students may qualify for a Certificate in Industrial Supervision that is both highly practical as well as theoretical. This program is designed to provide assistance to management in the development of qualified foremen and supervisors for industry.

REQUIRED COURSES FOR THE MAJOR

Bus 50*	Elements of Supervision
Bus 31*	Business Organization & Management
Bus 51*	Personnel Management
Bus 52+	Labor Management Relations
Bus 53*	Cost and Job Control for Supervisors
Bus 54*	Human Relations in Business
Bus 33A	Business Law I
Bus 9A-B	Business Lectures
Bus 33A	Business Law I
Psych 3	Personal & Social Adj.
Bus 39+	Business Communications

Evening students may substitute 6 units of General Education electives for Certificate Program and 12 units for the A.A. degree.

*A student currently employed in the field may receive an In-service Certificate in INDUSTRIAL SUPERVISION upon successful completion of the courses marked * and 6 additional units in General Education, for a total of 21 units.

+A student not currently employed in the field may receive a Pre-service Certificate in INDUSTRIAL SUPERVISION upon successful completion of the courses marked * plus the courses marked + and 9 additional units in General Education, including 6 units of Hum 1A or Hum 1B, for a total of 30 units.

retailing/marketing

Training in the marketing field can lead to employment by insurance companies, manufacturing firms, retailers, and wholesalers. Sales people are required for such diverse fields as specialty shops and automobile dealers. The movement of goods and services through good marketing procedures is a prime necessity of our economic system.

REQUIRED COURSES IN THE MAJOR

Bus 29*	Intro to Bus/Econ
or	
Bus 30*	Introduction to Business
Bus 37*	Marketing
Bus 35*	Salesmanship
Bus 31	Business Organization and Management
Bus 36*	Retail Merchandising
Bus 33A	Business Law I
Bus 50	Elements of Supervision
DP 1	Intro to Data Processing
Bus 38+	Advertising

RECOMMENDED COURSES IN THE MAJOR

Bus 3*	Applied Accounting
Bus 39+	Business Communications

A student currently employed in the field may receive an In-Service Certificate in RETAILING/MARKETING upon successful completion of the courses marked * and 6 additional units in General Education, for a total of 21 units.

+A student not currently employed in the field may receive a Pre-Service Certificate in RETAILING/MARKETING upon successful completion of the courses marked * plus the courses marked + and 9 additional units in General Education, including 6 units of Hum 1A or Hum 1B, for a total of 30 units.

stenography

This program is designed to provide entry-level employment in a secretarial position requiring a high level of stenographic ability.

REQUIRED COURSES IN THE MAJOR

Bus 11+	Beginning Typewriting
Bus 12+	Intermediate Typewriting
Bus 13*	Advanced Typewriting
Bus 14	Production Typewriting
Bus 20A*	Beginning Shorthand
Bus 20B*	Intermediate Shorthand
Bus 21*	Speed Building/Transcription
Bus 15	Secretarial Procedures
Bus 7	Calculating Machines
Bus 16	Office Machines
Bus 39*	Business Communications
Bus 19	Records Management

A student currently employed in the field may receive an In-Service Certificate in STENOGRAPHY upon successful completion of the courses marked * and 6 additional units in General Education, for a total of 21 units.

+A student not currently employed in the field may receive a Pre-Service Certificate in STENOGRAPHY upon successful completion of the courses marked * plus the courses marked + and 9 additional units in General Education, including 6 units of Hum 1A or Hum 1B, for a total of 30 units.

typing

This program is designed to provide entry-level job skills in a secretarial position emphasizing typing and machine transcription responsibilities with a minimum amount of stenography.

REQUIRED COURSES IN THE MAJOR

Bus 11+	Beginning Typewriting
Bus 12+	Intermediate Typewriting
Bus 13*	Advanced Typewriting
Bus 14*	Production Typewriting
Bus 7+	Calculating Machines
Bus 16	Office Machines
Bus 3	Applied Accounting
Bus 40	Personal Finance
Bus 19*	Records Management

RECOMMENDED COURSES FOR THE MAJOR

Bus 20A*	Beginning Shorthand
Bus 20B*	Intermediate Shorthand
Bus 39+	Business Communications

*A student currently employed in the field may receive an In-Service Certificate in SECRETARIAL upon successful completion of the courses marked * and 6 additional units in General Education, for a total of 21 units.

+A student not currently employed in the field may receive a Pre-Service Certificate in SECRETARIAL upon successful completion of the courses marked * plus the courses marked + and 9 additional units in General Education, including 6 units of Hum 1A or Hum 1B, for a total of 30 units.



special banking & finance program

The Department of Business and Economics is currently developing a program in banking and finance jointly sponsored by Moorpark College and the American Institute of Banking. The curriculum includes a Certificate Program and an Associate of Arts Degree in the area of banking and finance.

Special courses included in this curriculum are Principles of Bank Operations, Analysis of Financial Statements, and Installment Credit.

Considerable opportunities exist in the field of banking and finance with banks, savings and loans, finance companies and credit card companies. Additional information on this program may be secured by contacting Mr. William Rodgers, Chairman - Department of Business and Economics.



courses in business



Bus 1A/B - ACCOUNTING PRINCIPLES

3-3 Units

Prerequisites: Satisfactory math score or completion of Bus 3 or equivalent. Grade of C or better in 1A for 1B.
3 hours lecture weekly

Basic principles of accounting as a foundation for advanced study, and as a vocational skill; the accounting cycle, voucher system; problems involved in accounting for notes, expenses, assets, payroll, and for sole proprietorship; partnership; corporation; or manufacturing enterprise; financial statement analysis. Primarily for business administration majors. (F,S)
Equivalent to Bus 220A/B, CSUN
Accepted for credit, UC (all branches)

Bus 2 - ACCOUNTING - DATA PROCESSING LAB

1 Unit

Prerequisite: None
3 hours laboratory weekly

A lab course where students will have the opportunity to complete a realistic practice set using conventional means, and data processing techniques. The student will be exposed to solutions of accounting and management problems by use of current data processing techniques. Recommended for all accounting, management or marketing students.

Bus 3 - APPLIED ACCOUNTING**3 Units**

Prerequisites: None

2 hours lecture, 3 hours laboratory weekly.

Fundamentals of double-entry bookkeeping theory and application; the bookkeeping cycle and its application to sole proprietorship in trading concerns and service enterprises, financial statements; accounting for notes and securities; banking and petty cash transactions. (F,S)

Not open to students who have passed Bus 1A

Bus 7 - CALCULATING MACHINES**3 Units**

Prerequisites: None

2 hours lecture, 3 hours laboratory weekly.

Development of skill in the operation of the familiar makes of rotary calculators with problems to emphasize the arithmetic of percentage and interest; operation of the 10-key adding machine by the "touch" method. Practice on the rotary calculators and electronic calculators in the solution of more advanced problems; operation of the key-driven calculator by the "touch" system. (F,S,S)

Equivalent to Bus 212, CSUN

Bus 8 - PERSONAL TYPING**1½ Units**

Prerequisites: None

2 hours lecture, 3 hours laboratory weekly (8 weeks)

A personal typewriting course that consists of learning the mechanics of the typewriter and how to operate it. The students will attend daily class for 8 weeks and will learn basic typewriting skills. (F,S)

individualized typing laboratory

ITL is the new concept in typing classes at Moorpark College--the Individualized Typing Laboratory. The course is designed specifically for each student based upon his own goals (personal or career oriented and a prior typewriting background. Continuous enrollment will be offered to any college-registered student in any of the courses offered in the lab. Each student will be provided with individual assistance and evaluation from a certificated instructor. Each student will be able to progress at the rate of his capabilities and/or other time commitments.

The Audio Visual Tutorial (AVT) method of instruction presents short units of instruction on tapes and slides which are viewed in individual study carrels. The instruction provides for flexible, individualized scheduling as there are no regularly scheduled classes.

ITL will operate on an entirely free basis. Students will complete assignments at a time suitable to them, as long as they are in attendance five hours a week. An instructor will be available at all times to explain and give assistance.

The following 4 courses will be taught under this plan:

Bus 11A/B - BEGINNING TYPING

1½-1½ Units

Prerequisites: None

2 hours lecture, 3 hours laboratory weekly

Mastery of the keyboard, rhythmic writing; syllable, word and sentence practice; practice in simple business letters and tabulations; attainment of minimum speed of 35 words per minute. Elec. machines. (F,S)
Equivalent to Bus 101, CSUN

Bus 12A/B - INTERMEDIATE TYPING

1½-1½ Units

Prerequisite: Typing speed of 35 wpm, or C or better
from a previous typing class

2 hours lecture, 3 hours laboratory weekly

Skill building in typing office problem materials to meet business production standards. Individual speed improvement requirements set. (F,S)
Baccalaureate Level

Bus 13A/B - ADVANCED TYPING

1½-1½ Units

Prerequisites: Grade of C or better in Bus 12A/B/C
or speed of 50 wpm

2 hours lecture, 3 hours laboratory weekly

Advanced typewriting using electric typewriters with emphasis on business forms, multiple-page manuscripts, and intensive speed and accuracy development. (F,S)
Equivalent to Bus 201, CSUN

Bus 14A/B - PRODUCTION TYPING

1½-1½ Units

Prerequisites: Grade of C or better in Bus 12A/B/C or
speed of 60 wpm

2 hours lecture, 3 hours laboratory weekly

Emphasis of skill building on office-quality.
Baccalaureate Level

Bus 15 - SECRETARIAL PROCEDURES

5 Units

Prerequisites: Minimum typing speed of 50 wpm. Shorthand is
recommended for students enrolling in this course.
3 hours lecture, 6 hours laboratory weekly.

Instruction and practice in performing various office duties including methods of handling of mail, arranging itineraries, procuring office supplies, using the telephone, and improving human relations. Theory and practice in the selection and operation of dictation and transcribing machines, duplicating machines, copying machines, and proportional spacing typewriters. Field trips. (S)
Baccalaureate Level

Bus 16 - OFFICE MACHINES

3 Units

Prerequisites: Bus 11A/B or equivalent
2 hours lecture, 3 hours laboratory weekly

Course provides students with instruction in the operation of the following equipment: spirit duplicators, mimeographs, dry copiers, collator, proportional spacing typewriter, mimeoscope, and thermofax. (F)
Accepted for credit, CSUN

Bus 19 - RECORDS MANAGEMENT

2 Units

Prerequisites: None

1 hour lecture and 3 hours laboratory weekly

In this course the student will develop a sound foundation in the methods and systems of storing and retrieving information; plus gain insight into related management functions. (F)

Baccalaureate Level

Bus 20A - BEGINNING SHORTHAND

4 Units

Prerequisite: Bus 11A/B or typing speed of 40 wpm.

4 hours lecture, 1 hour laboratory weekly

Basic principles of reading and writing shorthand. Thorough study of Gregg theory, Diamond Jubilee Series. Students should attain a minimum speed of 60 wpm. Extensive dictation of practice material. (F,S)

Equivalent to Bus 102, CSUN

Bus 20B - INTERMEDIATE SHORTHAND

5 Units

Prerequisites: Two semesters of college shorthand (with grades of C or better) or 2 years of high school shorthand and one semester of college shorthand

5 hours lecture, 1 hour laboratory weekly

Increased speed on sustained dictation developed through the use of expert shortcuts and methods. Further development of accuracy in taking dictation to meet office standards. Specialization in vocabularies for medical and legal offices. Students should attain a minimum speed of 120 wpm. (F,S)

Baccalaureate Level

Bus 21 - SPEED BUILDING AND TRANSCRIPTION

5 Units

Prerequisites: Grade of C or better in Bus 20A, or one year of high school shorthand, and typing speed of 50 wpm.

4 hours lecture, 1 hour laboratory weekly.

Course comprises intensive review of shorthand principles, building dictation speed with unpracticed material. Students should attain a minimum speed of 80 wpm. (F,S)

Baccalaureate Level

Bus 22A/B - DIRECTED STUDIES IN BUSINESS

1-3/1-3 Units

Prerequisite: A course in the specific field and the consent of the instructor and division chairman.

1-3 hours tutorial weekly.

Designed for selected students who are interested in furthering their knowledge of business on an independent study basis. Assigned problems will involve library, laboratory, and field work. Maximum of 6 units.

Bus 23 - REFRESHER SHORTHAND

1 Unit

Prerequisites: Previous training in shorthand

2 hours lecture, 1 hour laboratory weekly (for 8 weeks)

This course is designed as a quick, yet thorough, review of Gregg Shorthand for those who have previously studied the system. Students *must* have had a complete course in Gregg. Course reviews all basic theory and transcription principles. Student may register for 2 eight-week sessions if beneficial. (F,S)

Bus 24 - REFRESHER/SECRETARIAL SKILLS**1-5 Units**

Prerequisite: None
1-5 hours lab

Course to refresh skills in one or more of five areas: filing, duplicating machine operation, calculating machine operation, transcribing machine operation, and business communication skills. With instructor's approval, students can receive one unit in each of above areas for completing a basic review program of skills.

Bus 29 - INTRODUCTION TO BUSINESS AND ECONOMICS**3 Units**

Prerequisites: None
3 hours lecture weekly

This course explores important concepts of business and economics by applying them to today's events in the world, the U.S. and Ventura County. Ideas about profits, supply and demand, money, insurance, costs, pricing, and management will be examined. Emphasis will be placed on the practical use of these concepts in one's everyday life. This class might be called "Econcepts of Business." (Co-numbered Econ 29)
Accepted for credit, CSUN

Bus 30 - INTRODUCTION TO BUSINESS PRINCIPLES**3 Units**

Prerequisites: None
3 hours lecture weekly

Purpose, organization and terminology of business, including such topics as management, insurance, budgeting and accounting, business law, organization, marketing and data processing. (F,S)
Baccalaureate Level

Bus 31 - BUSINESS ORGANIZATION AND MANAGEMENT**3 Units**

Prerequisite: None
3 hours lecture weekly

Basic functions of a business organization and manager's responsibilities in planning, organizing, directing, controlling, coordinating and executing the organizational objectives. (F,S)
Baccalaureate Level

Bus 32 - SMALL BUSINESS MANAGEMENT**1½-3 Units**

Prerequisites: None
3 hours lecture weekly

The role of the small businessman in the American economy, training in performing the various functions of business including setting up, staffing and organizing, advertising, selling, budgeting, and personnel for retail stores, service firms and industrial organizations. (F,S)
Baccalaureate Level

Bus 33A - BUSINESS LAW I**3 Units**

Prerequisite: Satisfactory score on Placement Test
3 hours lecture weekly

Fundamental principles of law as they relate to business transactions. Origins of legal system, law of contracts, enforceable agreements, real and personal property law, bailments, securities, transactions, court system; case approach emphasized. (F,S)
Equivalent to Bus 280, CSUN

Bus 33B - BUSINESS LAW II

3 Units

Prerequisite: Satisfactory score on Placement Test
3 hours lecture weekly

Principles of law as applied to employer-employee relationships, agency-legal relationships; rights and liabilities of parties, business organizations, and negotiable instruments; case approach emphasized. (S)
Accepted for credit, CSUN

Bus 34 - INCOME TAX LAW

2 Units

Prerequisites: None
2 hours lecture weekly

This course is designed to help students to understand principles of tax laws, court decisions, and administrative rulings as they apply to individual income taxes and preparation of returns. California income tax law is also discussed. (F)

Bus 35 - SALESMANSHIP

3 Units

Prerequisites: None
3 hours lecture weekly.

Elements of effective salesmanship; sales personality, development of the sales plan, securing prospects, counseling buyers, the demonstration, handling objections, self-management, and public relations.
Baccalaureate Level

Bus 36 - RETAIL MERCHANDISING

3 Units

Prerequisites: None
3 hours lecture weekly

Merchandise control and budgeting, location, equipment, advertising, discount stores, shifts in consumption patterns, credits and collections, and store services.
Baccalaureate Level

Bus 37 - MARKETING

3 Units

Prerequisites: None
3 hours lecture weekly

Marketing management from the viewpoint of the manager who researches and plans the product, organizes his staff, and controls the sales, advertising, and channels of distribution; case problem approach emphasized.
Baccalaureate Level

Bus 38 - ADVERTISING

3 Units

Prerequisites: None
3 hours lecture weekly

Introduction to the field of advertising. Media, budgeting, market research, layout, copywriting, advertising agencies. Student receives actual practice in the planning of an advertising campaign.
Baccalaureate Level

Bus 39 - BUSINESS COMMUNICATIONS

3 Units

Prerequisites: None
3 hours lecture weekly

Understanding of the theories of communication and barriers that prevent effective communication from taking place. Students develop the ability to write business letters in a variety of circumstances. Emphasis on vocabulary development and improvement of written communication skills.
Baccalaureate Level

Bus 40 - PERSONAL FINANCE**3 Units**

Prerequisites: None
3 hours lecture weekly

Basic course designed to improve student's management of personal financial affairs. Problem solving and practical experience in the development of an individual's budgets, investments, insurance, loans, taxes, social security, etc.
Baccalaureate Level

Bus 41 - CONSUMER LAW**3 Units**

Prerequisite: None
3 hours lecture weekly

Law for the consumer or layman surveying citizen's rights and obligations in our society. Practical application of law to common business transactions.

Bus 44 - BUSINESS MATH**3 Units**

Prerequisite: Math 9B or equivalent (may be taken concurrently)
3 hours lecture weekly

A review of fundamental arithmetic and algebraic processes with application to business problems. Fractions, decimals, skills in areas of mark-up, discounts, interest, installment debt and other business practices are presented. NOTE - this meets the college math requirement. (F,S) (Co-number: Math 44)

Bus 50 - ELEMENTS OF SUPERVISION**3 Units**

Prerequisites: None
3 hours lecture weekly

A basic course covering in general terms the total responsibilities of a supervisor; organization, duties and responsibilities, human relations, grievances, training, rating promotion, quality and quantity control.
Baccalaureate Level

Bus 51 - PERSONNEL MANAGEMENT**3 Units**

Prerequisites: Bus 50 or consent of instructor
3 hours lecture weekly

Personnel management as a staff function in the process of manpower administration in the organization. Policies and methods of obtaining and developing an efficient work force, including manpower planning, recruitment, selection, placement, training, management development, performance, evaluation, compensation practices, safety, benefits, and administration.
Baccalaureate Level

Bus 52 - LABOR MANAGEMENT RELATIONS**3 Units**

Prerequisite: Bus 50, Bus 51 or consent of instructor
3 hours lecture weekly

History and development of the labor movement, development of labor legislation – the National Labor Relations Acts, the Wagner Act, the Taft-Hartley Act; supervisor's responsibility for good labor relations, union contract and grievance procedure.
Baccalaureate Level

Bus 53 - COST AND JOB CONTROL FOR SUPERVISORS**3 Units**Prerequisite: Bus 50 or consent of instructor
3 hours lecture weekly

Determination of costs in industry; cost control and related factors materials, waste, salvage, quality control, quantity control, control of time, supervisor's responsibility for costs. Determination of job methods control and improvements; basic principles of work simplification including time and motion study techniques. Baccalaureate Level

Bus 54 - HUMAN RELATIONS FOR SUPERVISORS**3 Units**Prerequisites: Bus 50 or consent of instructor
3 hours lecture weekly

Designed to help the supervisor improve techniques of dealing with others. Emphasis on understanding human behavior, individualizing contacts with subordinates and applying management principles to interpersonal relationships. (Co-number Urban 54)
Baccalaureate Level

For information regarding Work Experience credit in the Business program, refer to Page 224 in this catalog.

Faculty: Eugene Berg, Richard Kurtik, Robert Miller, David Murphy,
Susan Patterson, David Wagner

chemistry

Chemists are concerned with the composition and properties of substances and changes in their composition; they search for new knowledge of the chemistry of matter and for ways of using this knowledge. Chemistry is by far the largest field of employment in the sciences. A wide range of opportunities awaits the chemist in business, industry, government, and in the field of education. Approximately three-fourths of all chemists are employed by private industry in such fields as petroleum, primary metals, electrical equipment, aerospace, paper, food, and rubber. The graduate can find many applications for his training, such as teaching, research, management, production, and sales. Also government agencies of all sorts are in need of personnel with such training.

REQUIRED COURSES IN THE MAJOR**California State University, Northridge**

Chem 1A-B	General Chemistry
Chem 5	Quantitative Analysis
Chem 7A	Organic Chemistry
Math 25ABC	Calculus with Analytic Geometry
Math 35	Applied Differential Eq.
Ph 4	Mechanics of Solids & Fluids
Ph 5	Electricity and Magnetism
Ph 6	Heat, Sound, Optics & Modern Physics
Ger 1A-B	German

University of California, Santa Barbara

Chem 1A-B	General Chemistry
Chem 5	Quantitative Analysis
Chem 7A-B	Organic Chemistry
Math 25ABC	Calculus with Analytic Geometry
Ph 4	Mechanics of Solids & Fluids
Ph 5	Electricity and Magnetism
Biol 2A	General Biology
Ger 1A-1B	German
or	
Fr 1A-1B	French



courses in chemistry

Chem 1A - GENERAL CHEMISTRY

5 Units

Prerequisites: High School Chemistry, or Chem 12,
and Math 3 or equivalent

3 hours lecture, 6 hours laboratory weekly

This course is required of all majors in chemistry and most other fields of science and technology, and is also transferable as a laboratory science course or general education requirement for majors in any field.

Lecture: This course will describe matter in terms of composition and structure from the viewpoint of the atomic theory, atom structure and atom bonding. Properties of matter will be considered from a kinetic molecular theory, gas laws, colligative properties, and nuclear chemistry.

Laboratory: Some basic arts and techniques of Experimental Investigation will be explored. Spectroscopy, Gravimetric Volumetric Analysis, Stoichiometry solutions, Qualitative Analysis.

Equivalent to Chem 101, CSUN

Accepted for credit, UC (all branches)

Chem 1B - GENERAL CHEMISTRY

5 Units

Prerequisite: Chem 1A

3 hours lecture, 6 hours laboratory weekly

Lecture: Molecular interactions, reaction dynamics, thermochemistry, and thermodynamics, chemical, physical and solution equilibrium, electro-chemistry. Why and how chemical reactions occur. Systematic descriptive chemistry.

Laboratory: Volumetric and gravimetric analysis, Kinetics, electro-chemical determinations, calorimetry, equilibrium, acid-base reactions. (F,S)

Equivalent to Chem 102, CSUN

Accepted for credit, UC (all branches)

Chem 5 - QUANTITATIVE ANALYSIS

4 Units

Prerequisites: Grade of C or better in Chem 1A/B or equivalent
or consent of instructor

2 hours lecture, 6 hours laboratory weekly

The course will consider analytical chemical techniques. The emphasis will be in instrumental analytical procedures. The analysis will be Gravimetric, Volumetric, Potentiometric and Spectrophotometric. (F)

Equivalent to Chem 211, CSUN

Accepted for credit, UC (all branches)

Chem 7A/B - ORGANIC CHEMISTRY

5-5 Units

Prerequisites: Grade of C or better in Chem 1A/B or consent of instructor

3 hours lecture, 6 hours laboratory weekly

A thorough study of organic chemistry. Emphasis is placed on application of modern principles to a study of the structure, reactivity and synthesis of aliphatic and aromatic compounds. Techniques, preparation and identification of organic chemicals using modern instrumental methods.

Accepted for credit, CSUN

Accepted for credit, UC (all branches)

Chem 10A - DESCRIPTIVE CHEMISTRY

1 Unit

Prerequisites: Consent of instructor

16 hours lecture

A description of the basic principles of chemistry and science. Emphasis will be placed on structure of the atom as it relates to bonding and chemical reactions.

Accepted for credit, CSUN

Chem 10B - DESCRIPTIVE CHEMISTRY

1 Unit

Prerequisites: Chem 10A or consent of instructor

16 hours lecture

A description of the basic principles of chemistry. Emphasis will be placed on the oxidation of materials including chemical rates and heats of reaction.

Accepted for credit, CSUN

Chem 10C - DESCRIPTIVE CHEMISTRY

1 Units

Prerequisites: Chem 10A, 10B or consent of instructor

16 hours lecture

A description of the basic principles of chemistry. Emphasis will be placed on the structure and reactivity of dangerous chemicals. Included will be radioactive materials, explosives and flammable materials.

Accepted for credit, CSUN

Chem 12 - ELEMENTARY CHEMISTRY I**4 Units**

Prerequisite: Math 1 recommended
3 hours lecture, 3 hours laboratory weekly.

A course designed for non-science majors, emphasizing principles of inorganic chemistry, structure of atoms and molecules, periodic table and chemical calculations. This course fulfills prerequisite requirements for Chem 1A.
Equivalent to Chem 103, CSUN

Chem 13 - ELEMENTARY CHEMISTRY II**4 Units**

Prerequisite: Chem 12
3 hours lecture, 3 hours laboratory weekly.

A continuation of Chem 12. A course emphasizing properties of solution, chemical equilibrium, acids and bases, and reaction Kinetics. The laboratory experiences are designed for practical applications in Home Economics, Agriculture and Environmental Chemistry.
Equivalent to Chem 104, CSUN

Chem 22A/B - DIRECTED STUDIES IN CHEMISTRY**1-3 Units**

Prerequisites: A course in the specific field and the consent
of the instructor and Division Chairman
1-3 hours tutorial weekly

Designed for selected students who are interested in furthering their knowledge of chemistry on an independent study basis. Assigned problems will involve library, laboratory, and field work. Maximum of 6 units.
3 unit maximum credit, CSUN
Accepted for credit, UC (all branches)

cinematography

Cine 1 - HISTORY OF THE MOTION PICTURE**3 Units**

Prerequisites: None
3 hours lecture weekly

An historical and critical survey, with examples of the motion picture both as a developing art form and as a medium of mass communication.
Accepted for credit, CSUN

Cine 2A/B - ART AND TECHNIQUES OF FILM**3-3 Units**

Prerequisites: Suggested - Journ 1/Broad 1, Photo 1A and Cine 1
2 hours lecture, 3 hours laboratory weekly

A basic course presenting techniques of motion picture photography, script writing, and film production. Several areas are covered including documentary, educational, and expressive modes. Productions in both super 8 and 16mm.
Baccalaureate Level

For information regarding Work Experience credit in the Cinematography program, refer to Page 224 in this catalog.

communication arts

The Communication Arts program cluster offers career opportunities related to the significant and rapidly growing field of Mass Communication. Career opportunities involve those in newspapers, magazines, television, radio, advertising, public relations, photography, cinematography, industry and/or government communications, and teaching. Five basic courses are recommended from the programs in the cluster that will afford an opportunity to the student to get a basic understanding and introduction to fields of possible interest. Those basic classes are the following:

Broad 1/ Journ 1	Introduction to Mass Communications
Photo 1	Beginning Photography
Art 4A	Color and Design
GC 4	Layout and Design Techniques
Cine 1	History of the Motion Picture

The different fields of study comprising the Communication Arts program cluster are those listed below:

Broadcasting
Cinema
Commercial Art/Applied Design
Graphic Communications
Journalism
Photography

The curriculum patterns and course descriptions for these six areas of concentration are to be found under their respective headings in this section of the catalog.

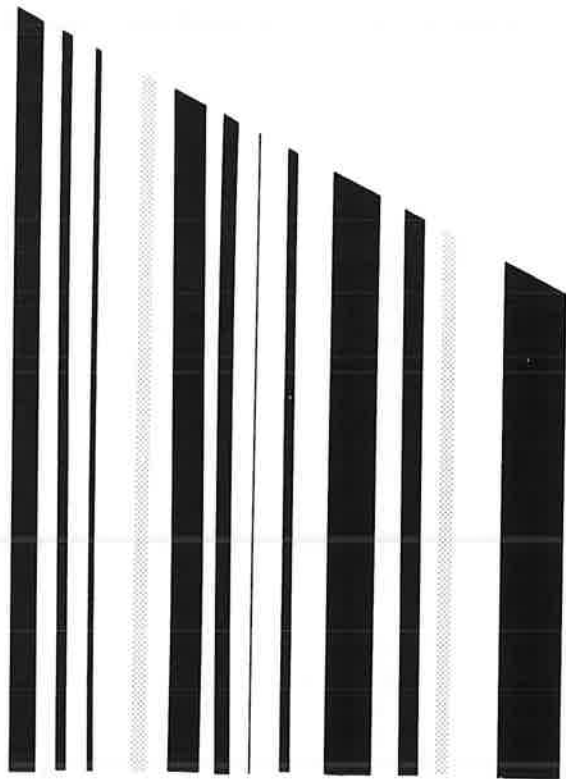
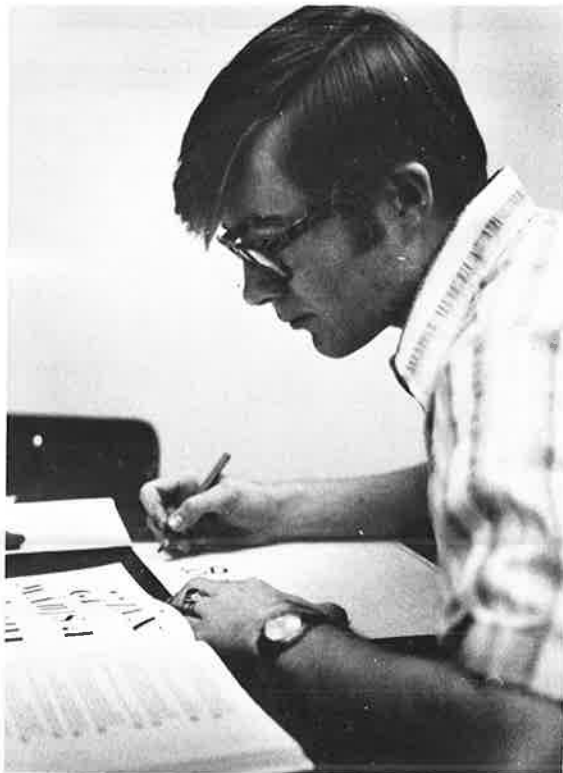

data processing

Designed to prepare students for employment in business utilizing data processing equipment. Training is provided in data processing machines, data processing systems and computer programming. Completion of this curriculum should qualify students for employment as entry-level programmers or as management trainees in stored programming.

REQUIRED COURSES IN THE MAJOR

DP 1*	Intro to Data Processing	Bus 31*	Bus Org. & Manage.
DP 4A*	Computer Program. I	Bus 1A+	Accounting Principles
DP 4B*	Computer Program. II	Bus 1B+	Accounting Principles
DP 6*	Data Process. Systems		
DP 5	Computer Program. BAL		
DP 9	Computer Programming Laboratory		

*A student currently employed in the field may receive an In-service Certificate in DATA PROCESSING upon successful completion of the courses marked * and 6 additional units in General Education, for a total of 21 units.

+A student not currently employed in the field may receive a Pre-service Certificate in DATA PROCESSING upon successful completion of the courses marked * plus the courses marked + and 9 additional units in General Education, including 6 units of Hum 1A or Hum 1B, for a total of 30 units.

DATA PROCESSING TRANSFER MAJORS

The data processing course offerings may be used as preparation for transfer as a data processing major to specific four year schools. Students are prepared for systems analyst and programmer positions in industry, commerce, finance, education and government service by this curriculum.

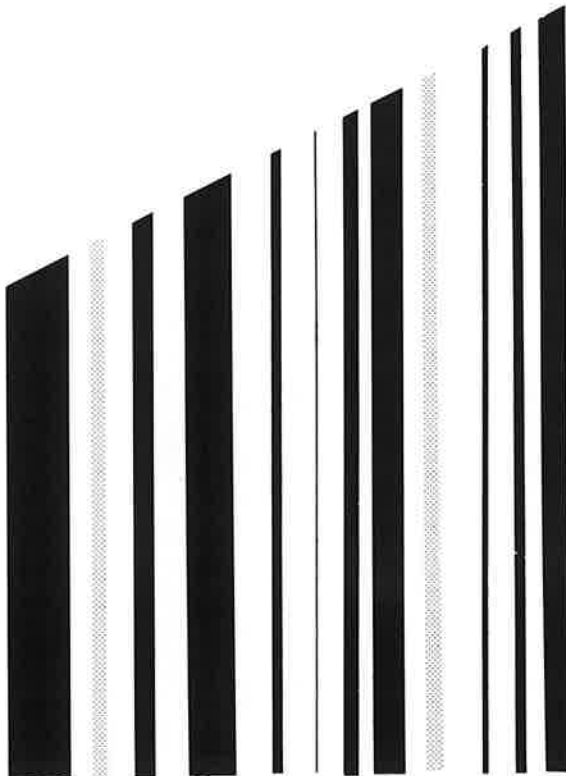

REQUIRED COURSES FOR THE TRANSFER MAJOR

Cal Poly At Pomona

DP 1	Intro to Data Processing	Bus 37	Marketing
DP 4A	Computer Program. I	Bus 1A/B	Accounting Principles
DP 4B	Computer Program. II	Econ 1A/B	Principles of Econ.
DP 6	Data Process. Systems		
DP 9	Computer Program. Laboratory		
Bus 31	Bus. Org. & Management		
Bus 33A	Business Law I		

courses in data processing

DP 1 - INTRODUCTION TO DATA PROCESSING

3 Units

Prerequisites: None. (For Data Processing majors only.)

3 hours lecture weekly

Basic methods, techniques and systems of data processing, development of data processing functions as applied in manual, mechanical, electro-mechanical and electronic data processing systems. (F,S)

Equivalent to DP 211, Cal Poly Pomona

Accepted for credit at UC (all branches)

Accepted for credit, CSUN

DP 4A - COMPUTER PROGRAMMING I

3 Units

Prerequisite: DP 1 and 2 years of high school algebra or Math 7 with a grade of C or better.

3 Hours lecture weekly

Familiarization with basic digital computer programming concepts; study of programming using COBOL. Discussion of absolute and symbolic programming systems.

Equivalent to DP 231, Cal Poly Pomona

Equivalent to Bus 224, CSUN

DP 4B - COMPUTER PROGRAMMING II

3 Units

Prerequisites: DP 1 and DP 4A. Concurrent enrollment in DP 9 recommended

3 hours lecture weekly

A study of automatic programming systems and their applications to the solution of business data processing problems; using COBOL, disc concepts. (F,S)

Accepted for credit at Cal Poly Pomona

Accepted for credit at UC (all branches)

Equivalent to Bus 222, 223, CSUN

DP 5 - COMPUTER PROGRAMMING BAL

3 Units

Prerequisites: DP 1, DP 4A and DP 4B or approval of the instructor. High School algebra or Math 3 desirable. Concurrent enrollment in DP 9 recommended

3 hours lecture weekly

Familiarization with programming for the third generation "byte" computers stressing the IBM/360 series.

Accepted for credit at Cal Poly Pomona

Accepted for credit, CSUN

DP 6 - DATA PROCESSING SYSTEMS**3 Units**

Prerequisite: DP 1, or consent of instructor
3 hours lecture weekly

Data processing systems and procedures, analysis of various existing business data processing principles. Required of most business and economics departments for non-data and data systems concepts. (S)
Equivalent to DP 222, Cal Poly Pomona
Accepted for credit, CSUN

DP 7A - COMPUTER PROGRAMMING RPG**1½ Units**

Prerequisites: DP 1 or approval of the instructor. Concurrent enrollment in DP 9 recommended
3 hours lecture weekly for 8 weeks

Basic computer programming concepts and development techniques. Laboratory development and problem solution using IBM Report Program Generator.
Accepted for credit, UC (all branches)

DP 7B - GENERAL PURPOSE SIMULATIVE SYSTEM**1½ Units**

Prerequisites: DP 1 and at least one semester of computer programming
3 hours lecture weekly for 8 weeks

Familiarization with concepts and techniques of using a computer for the operation of simulation models.
Accepted for credit, UC (all branches)

DP 8A - OPERATING SYSTEMS**1½ Units**

Prerequisites: DP 1 and at least one semester of computer programming
3 hours lecture weekly for 8 weeks

Concepts, techniques and use of operating systems. Methods of coding and maintenance of operating systems for computers with multi-processing capabilities.
Accepted for credit, UC (all branches)

DP 8B - DATA MANAGEMENT**1½ Units**

Prerequisites: DP 1 and at least one semester of computer programming
3 hours lecture weekly for 8 weeks

Familiarization with concepts and techniques of data files construction, management and control.
Accepted for credit, UC (all branches)

DP 9 - COMPUTER PROGRAMMING LABORATORY*1 Unit**

Prerequisites: DP 4A, 4B, 5 or 18 concurrent, or consent of instructor
3 hours laboratory weekly

Laboratory experience to accompany computer programming classes. Actual programming of problems to support the lecture portions of the classes. This course offered on "Credit-No Credit" basis only.

*** DP 10 - DATA PROCESSING METHODS FOR BUSINESS** **2 Units**
Prerequisite: None.
2 hours lecture weekly.

An introductory course covering the history, development and application of data processing principles. Required of most business and economics departments for non-data processing majors. Not open to students who have completed DP 1. Accepted for credit, CSUN

*May be repeated for credit up to 4 times.

DP 11 - KEYPUNCH OPERATION **1 Unit**
Prerequisite: High school typing or equivalent or consent of instructor.
1 hour lecture, 3 hours laboratory (8 weeks)

The basic operation principles of the IBM 029 keypunch with laboratory experience on the equipment. (F,S)

DP 18 - COMPUTER PROGRAMMING - FORTRAN **3 Units**
Prerequisite: Math 3 or one and one-half years of high school algebra.
Concurrent enrollment in DP 9 recommended.
3 hours lecture weekly

Familiarization with basic digital computer programming concepts. Designed to introduce physical science, life science, social science, business, engineering and mathematics students to the computer in problem solving, emphasizing the use of FORTRAN language. (F,S) (co-number Math 18)
Equivalent to Bus 223, CSUN
Accepted for credit, UC (all branches)

DP 20 - INTRODUCTION TO NUMERICAL METHODS **3 Units**
Prerequisites: Math 18/DP 18 and Math 16
OR Math 18/DP 18 and Math 25A
3 hours lecture weekly

Power series calculation of functions; error analysis; roots of equations; nonlinear simultaneous equations; matrices, determinants, and linear simultaneous equations; numerical integration; interpolation and curve fitting. These numerical methods will be practically applied on the latest computer hardware using Fortran IV language and de-bugging of practice problems. (Co-number Math 20)
Baccalaureate Level

DP 22A/B - DIRECTED STUDIES IN DATA PROCESSING **1-3/1-3 Units**
Prerequisite: Advanced standing and consent of instructor
and Division Chairman
1-3 hours tutorial weekly

Designed for selected students who are interested in furthering their knowledge of Data Processing on an independent study basis. Assigned work can involve the programming of a complete data processing application under the direction and guidance of an instructor. (Maximum 6 units)

For information regarding Work Experience credit in the Data Processing program, refer to Page 224 in this catalog.



early childhood development

Faculty: Dolores Deutsch, Coordinator; Dorothy Nasatir

Early Childhood Development courses offer students a range of academic and participatory experience in the areas of Child Growth and Development and Nursery Education. There is a developing need for trained teachers and aides to work with young children in Nursery School Programs. The increasing number of working mothers with children and the need for working with children from the economically disadvantaged groups has increased the demand in the private nursery school as well as the Headstart day centers. It is an exciting and useful career for part-time and full-time employment, for both men and women. It provides an opportunity to be of service in an area of great need.

REQUIRED COURSES IN THE MAJOR

ECD 30A*	Child Growth & Development	Select 2 from the following 4 Specialty Areas
ECD 38*	Observation in the Nursery School	ECD 51 Music in the Nursery School
ECD 39A*-B+	Supervised Participation in the Nursery School	ECD 52 Art in the Nursery School
ECD 40*	Child, Family & Community	ECD 53 Science in the Nursery School
ECD 41*	Nursery School Programs	ECD 54 Literature in the Nursery School
ECD 43+	Parent & Teachers Communications & Conferencing	HS 5 First Aid & Safety
		Psych 2+ General Psychology

RECOMMENDED COURSES FOR THE MAJOR

ECD 42† Nursery School Administration
and Supervision

*A student currently employed in the field may receive an In-service Certificate in Nursery Education upon successful completion of the courses marked * and 6 additional units in General Education, for a total of 21 units.

+A student not currently employed in the field may receive a Pre-service Certificate in Nursery Education upon completion of the courses marked * plus the courses marked + and 9 more units of General Education, including 6 units of Hum 1A or Hum 1B, for a total of 30 units.

†Required for approval and licensing by the State Department of Social Welfare as Director and/or Administrator of a Nursery School facility.

courses in early childhood development

ECD 22A/B - DIRECTED STUDIES IN EARLY CHILDHOOD DEVELOPMENT

1-3/1-3 Units

Prerequisites: A course in the specific field and the consent of the instructor and Division Chairman.

1-3 hours tutorial weekly

Designed for selected students who are interested in furthering their knowledge of Early Childhood Development on an independent study basis. Assigned problems will involve library, laboratory, and field work. Maximum of 6 units.

ECD 30A - CHILD GROWTH & DEVELOPMENT I

3 Units

Prerequisites: None

3 hours lecture weekly

A study in depth of the social, emotional and physical development of the normal child in relation to the home and the early years of school; special attention to prenatal and infant development.
Accepted for credit, CSUN

ECD 30B - CHILD GROWTH AND DEVELOPMENT II

3 Units

Prerequisites: ECD 30A

3 hours lecture weekly

Knowledge and understanding of how the social, intellectual, physical and emotional growth of the baby and young child affects the child from infancy to adolescence; emphasis on the relationship of early childhood development to the child's later functioning academically, psychologically and socially in school, with his peers, and in his family.
Accepted for credit, UC (all branches)

ECD 31A - GROWTH & DEVELOPMENT OF THE EXCEPTIONAL CHILD I

3 Units

Prerequisites: ECD 30A

3 hours lecture weekly

The social, emotional, and physical development of the exceptional child in relation to the home, community, hospital and nursery school. Special attention to the child's motor, speech, perceptual and psychological development.
Accepted for credit, UC (all branches)

ECD 31B - GROWTH & DEVELOPMENT OF THE EXCEPTIONAL CHILD II

3 Units

Prerequisites: ECD 30A and ECD 31A or consent of instructor
3 hours lecture weekly

Identifying and understanding children with learning disabilities such as hyperactive, highly gifted, mentally retarded, and those with communication or perceptual difficulties. To assist potential teachers and parents in planning and implementing programs and curriculum for these children at school and at home.
Accepted for credit, UC (all branches)

ECD 38 - OBSERVATION IN THE NURSERY SCHOOL

3 Units

Prerequisites: None
2 hours lecture, 3 hours laboratory weekly

An introduction to child growth and development and working with young children in the nursery school setting. Students will observe children's activities in the nursery school (with guidance) and then will participate in the actual program with limited assignments.
Accepted for credit, CSUN

ECD 39A - SUPERVISED PARTICIPATION IN THE NURSERY SCHOOL

3 Units

Prerequisites: ECD 30 and ECD 38 or permission of instructor
2 hours lecture, 3 hours laboratory weekly

Training in nursery school procedures and practices for students who will be teaching young children or those who are now employed in nursery schools, Head Start Centers, and day-care facilities. Students will gain practical experience while actually working with the young children in the nursery school setting.

ECD 39B - SUPERVISED PARTICIPATION IN THE NURSERY SCHOOL

3 Units

Prerequisites: ECD 39A or permission of instructor
2 hours lecture, 3 hours laboratory weekly

Extended training in observation, participation and planning of the nursery education experiences of young children in community nursery school settings; i.e., child care facility, private and church programs, Head Start and special education in addition to the campus laboratory experience.

ECD 40 - CHILD, FAMILY AND COMMUNITY

3 Units

Prerequisites: None
3 hours lecture weekly

Pattern of child-rearing in contemporary society. Interaction of family and community. Significance of personal and social values in family life and community action. Individual and social resources for family health and welfare and improving child development.
Accepted for credit, CSUN

ECD 41 - NURSERY SCHOOL PROGRAMS

3 Units

Prerequisites: None
3 hours lecture weekly

A survey of philosophies and programs in the field of Nursery Education. Experience in planning a curriculum for a nursery school program. Special emphasis provided for selection and arrangement of equipment and materials to furnish a rich environment for the mental and physical growth of nursery school children.
Accepted for credit, CSUN

ECD 42 - NURSERY SCHOOL ADMINISTRATION AND SUPERVISION 3 Units
Prerequisites: ECD 40 and ECD 41 or consent of instructor
3 hours lecture weekly

Origin of nursery school movement in California. Types and essentials of nursery schools, including licensing, legislation standards, daily routines, teacher responsibility, and public relations. This course will include principles and practices of communication skills for the teacher and administrator with other staff members in the Nursery School and between the school and the home.

ECD 43 - PARENT AND TEACHER COMMUNICATIONS AND CONFERRING 3 Units
Prerequisites: ECD 40
3 hours lecture weekly

A course to increase knowledge and effectiveness in parent-teacher conferencing with an emphasis on techniques that facilitate skillful communication. Understanding parental and teacher goals and expectations in relationship to the young child.

ECD 44 - FAMILY DYNAMICS IN THE TEACHING-LEARNING PROCESS 3 Units
Prerequisites: None
3 hours lecture weekly

This course will offer research, materials and experiences which will provide parents and other adults in the community with an opportunity to study the varied aspects of the education of young children; there will be a focus on establishing closer ties between the school and the family and on the parent as a teacher.

ECD 50 - EARLY CHILDHOOD INSTITUTE 1-3 Units
Prerequisites: None

A short term lecture-workshop series designed primarily for a nursery school personnel in the teaching and administrative roles. This course will provide opportunity to gain understanding and skills in the areas of communication with children, parents, staff, and community agencies.

ECD 51 - MUSIC IN THE NURSERY SCHOOL 3 Units
Prerequisites: None
3 hours lecture weekly

Designed to help teachers in understanding the growth and development of children in relation to music at home and at school. Also to help prospective teachers of young children gain skill in conducting a music program in the Nursery School. In particular, emphasis will be placed on skill, construction and playing of simple musical instruments, creative rhythm, and composing songs.

ECD 52 - ART IN THE NURSERY SCHOOL 3 Units
Prerequisites: None
3 hours lecture weekly

To provide opportunities for teachers to learn how to help their children in the field of art. To help teachers in understanding the growth and development of children in relation to creative experience both at home and at school. The development of practical materials in the creative arts and an understanding of the individual child to his own creative expression.

ECD 53 - SCIENCE IN THE NURSERY SCHOOL

3 Units

Prerequisites: None
3 hours lecture weekly

To provide opportunities for teachers to learn how to help their children in the field of science. To help teachers in understanding the growth development of children in relation to science both at home and at school; the development of practical materials in a science area.

ECD 54 - LITERATURE IN THE NURSERY SCHOOL

3 Units

Prerequisites: None
3 hours lecture weekly

Exploration of various experiences appropriate to the development of young children including picture books, flannel graphs, poetry, puppetry, records television, dramatic play. Emphasis on developing language concepts and skills.

ECD 55 - CREATIVE MOVEMENT ACTIVITIES FOR CHILDREN

3 Units

Prerequisites: None
3 hours lecture weekly

A presentation of methods and materials which parents and teachers of pre-school and early elementary aged children can utilize in encouraging and directing creative movement experiences in the school, home, or various organizations (YMCA, church). (Co number PE 97)

For information regarding Work Experience credit in the Early Childhood Development program, refer to Page 224 in this catalog.



economics

Faculty: William Dickneider, Peter Gucciardo, Richard Moore

The major in economics is designed for students interested in an understanding of the operation of our economy and the operation of the business firm. The economic major leads to careers in industry or government, to graduate study in the field of economics, to professional careers as economists and to careers in teaching. The major also offers valuable preparation for careers in law and journalism.

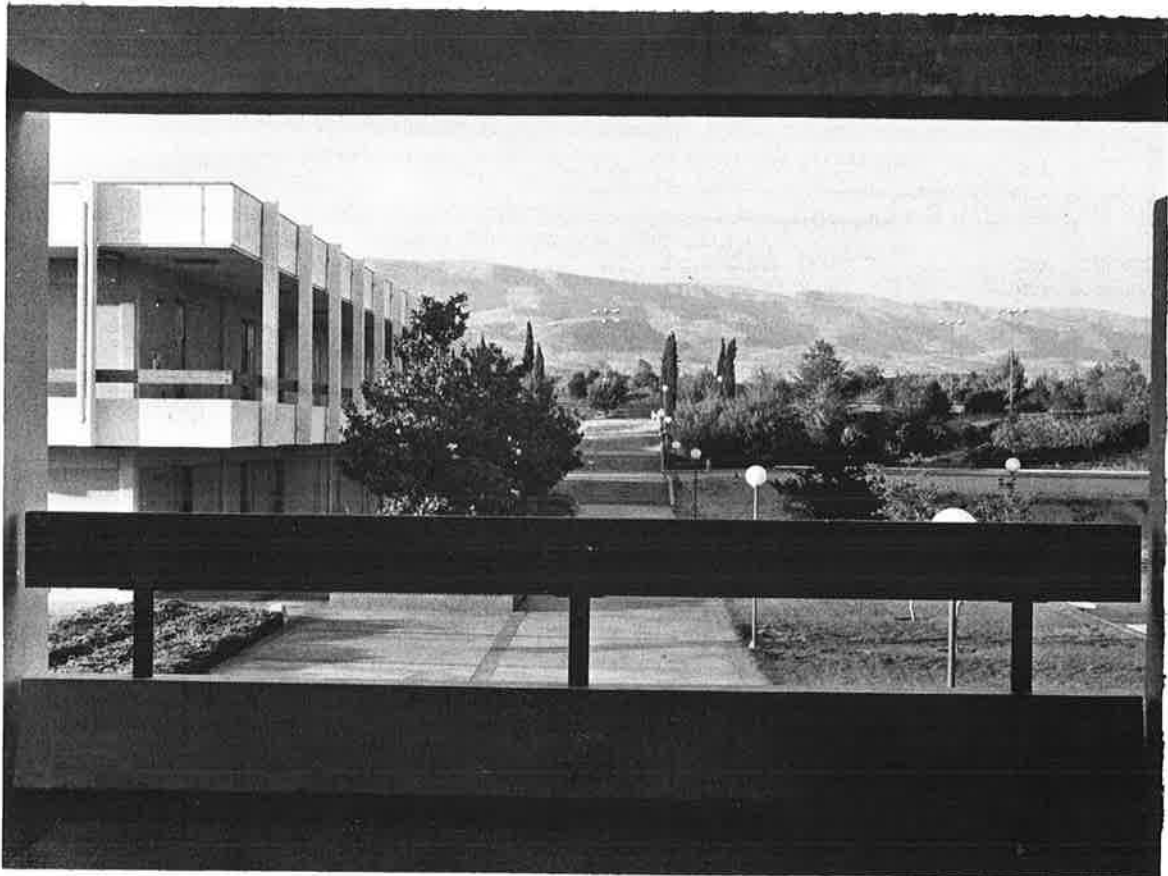

REQUIRED COURSES IN THE MAJOR

California State University, Northridge

Econ 1A-1B	Principles of Economics
Bus 1A-1B	Accounting Principles
Math 12	Coll Algebra/w Bus. Appl.
Math 14	Finite Math
Phil 1A	Introduction to Philosophy

University of California, Santa Barbara

Econ 1A-1B	Principles of Economics
Math 15	Introductory Statistics
Math 25A	Calculus w/Analytical Geom
For Lan	Foreign Language

courses in economics

Econ 1A/1B - PRINCIPLES OF ECONOMICS

3-3 Units

Prerequisites: Satisfactory score on placement test; classes
may be taken concurrently or in any order desired
3 hours lecture weekly

ECON 1A: Students will develop a method of thinking about daily events by exploring macro-economic theory and applying it to current issues. An examination of economic growth and of our economy as a circulatory system; reasons for unemployment and inflation. Students will also analyze the taxing, spending, and money policies used by the government to affect the economy and analyze the use of money and banking in our economy.

Equivalent to Econ 150, CSUN

Accepted for credit, UC (all branches)

ECON 1B: Students will develop a method of thinking about daily events by exploring micro-economic theory and applying it to current issues. Demand and supply forces that determine prices and the effects of those prices on human behavior; how big and small businesses make their pricing and production decisions and how those decisions affect society. Economic reasons for environmental pollution and possible solutions from the point of view of cost-benefit analysis. Students will also study the distribution of national income, the coordination of international trade, and the creation of periodic crises in the international monetary system.

Equivalent to Econ 160, CSUN

Accepted for credit, UC (all branches)

Econ 10 - THE AMERICAN ECONOMY

3 Units

Prerequisites: None
3 hours lecture weekly.

A survey of the American economy with emphasis on the development, functioning, and significance of economic institutions of concern to citizens. The monetary system, consumer-producer relationships, the role of government and fiscal policy, business cycle, international funds, and unemployment are examined in detail.

Accepted for credit, CSUN

Econ 29 - INTRODUCTION TO BUSINESS AND ECONOMICS

3 Units

Prerequisites: None
3 hours lecture weekly

This course explores important concepts of business and economics by applying them to today's events in the world, the U.S. and Ventura County. Ideas about profits, supply and demand, money, insurance, costs, pricing, and management will be examined. Emphasis will be placed on the practical use of these concepts in one's everyday life. This class might be called "Econcepts of Business." (Co-numbered Bus 29)

Econ 22A/B - DIRECTED STUDIES IN ECONOMICS**1-3/1-3 Units**

Prerequisites: A course in the specific field and consent of the instructor and Division Chairman.

1-3 hours tutorial weekly.

Designed for the curious and responsible student who has already demonstrated sufficient proficiency in economics. Intent is to permit by means of independent study the student's further pursuit of economics. Maximum of 6 units.
Accepted for credit, UC (all branches)



education

Ed 1 - INTRODUCTION TO EDUCATION**3 Units**

Prerequisites: None
3 hours lecture weekly

An introduction to a career in education and the issues and problems involved at all levels of American Education. Includes such areas as the historical, social, philosophical and psychological foundations and organization of education, and examines the contribution of educators to the profession, students, and the community.

Accepted for credit, CSUN

Ed 7 - INSTRUCTIONAL MATERIALS LABORATORY**2 Units**

Prerequisites: Teaching Credential or consent of instructor
1 hour lecture, 3 hours laboratory weekly

A comprehensive laboratory course for the purpose of developing instructional materials for the classroom. Materials covered are charts, posters, slides, filmstrips, overhead transparencies, slide-tape, presentations, photocopies and thermal master.

Ed 10A - INSTRUCTIONAL SKILLS I**3 Units**

Prerequisites: Satisfactory score on Placement Test
3 hours lecture weekly

A survey of educational philosophies, problems, principles, objectives, methods, and materials which classroom aides will encounter in elementary or secondary school. Special attention given to practical learning theory, techniques for individualizing instruction, components of an integrated lesson, assessment measures, and curriculum content, especially in the basic skills. Multi-media presentations. Aide utilization and differentiated staffing clarified. Course may be taken to meet Pre-service or In-service needs.

Ed 10B - INSTRUCTIONAL SKILLS II**3 Units**

Prerequisites: Ed 1A
3 hours lecture weekly

Expanded treatment of course content introduced in Education 1A. Particular emphasis given to teaching reading, listening, math, and language arts. Aides will give demonstration lessons. Attention given to learning disabilities.

Ed 12 - BEHAVIORAL PRINCIPLES**3 Units**

Prerequisites: Consent of instructor
3 hours lecture weekly

An introduction to behavioral theory in learning principles. Consideration will be given to experimental analysis of behavior, antecedent, and consequences, as well as a demonstration of ability to alter behavior using contingencies of reinforcement and stimulus control. Emphasis will be on class discussion and peer learning as well as selected class studies.

Ed 13 - BEHAVIORAL TECHNIQUES**3 Units**

Prerequisites: Ed 12 and consent of instructor
3 hours lecture weekly

This course will examine counter-conditioning theory and practice, including the formulation of a counter-conditioning therapy program which will be implemented with a selected subject. Emphasis will be on developing a competence in utilizing counter-conditioning techniques.

Ed 14 - CONTINGENCE MANAGEMENT**3 Units**

Prerequisites: Ed 13 and consent of instructor
3 hours lecture weekly

A review of contingencies of reinforcement as they apply to educational and mental health settings. Laboratory assignments will focus on the application of contingencies of reinforcements involving the effect of behavioral consequences, transfer from continuous interval schedules of reinforcement and behavioral self-control experiments.

Ed 15 - APPLIED BEHAVIOR FOR PARENTS**3 Units**

Prerequisites: Ed 14 and consent of instructor
3 hours lecture weekly

A review of the basic principles of human behavior, especially as applied to child management and child development. Attention will be given to the use of behavior modification methods in improving children's behavior.

Ed 22A/B - DIRECTED STUDIES IN EDUCATION**1-3/1-3 Units**

Prerequisites: Consent of instructor and Division Chairman
1-3 hours tutorial weekly

Designed for selected students who are interested in furthering their knowledge of education on an independent study basis. Assigned problems will involve library and field work. Maximum of 6 units.

Ed 48A/B - EDUCATION PRACTICUM

1-3/1-3 Units

Prerequisites: Ed 1A (may be taken concurrently) and consent of instructor

On-the-job training without financial compensation as an instructional aide under the continuous direction and supervision of an instructor. Prior to enrollment in the course, the student must meet with the director of the instructional aide program for approval and assignment to his/her class.

For information regarding Work Experience credit in the Education program, refer to Page 224 in this catalog.

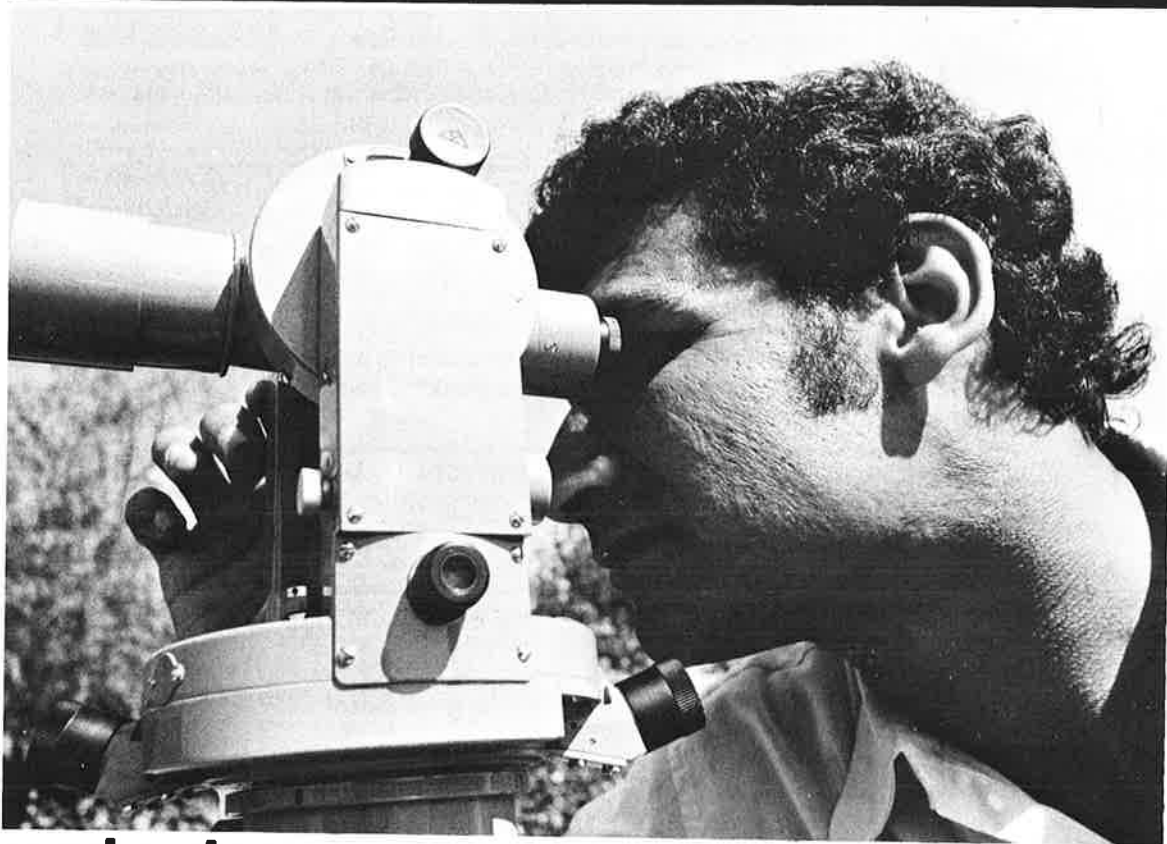

engineering

The engineering profession offers diversified and meaningful opportunities to those who are qualified and who complete the necessary academic work. The minimum education for the engineer is a Bachelor of Science degree, but many find higher degrees desirable.

Engineering specialties are many and students should carefully select courses which will apply in their chosen field. With minor exceptions, however, the first two years of all engineer programs are identical. This work may be completed at Moorpark College, and the student subsequently transfers to a four-year college for the final two years. Because of differences in engineering schools, the programs listed below, although representative, should be checked with counselors and with the college to which the student will transfer. The student would do well to carefully study the catalog of the transfer institution.

The study of engineering is stimulating and satisfying, but it is also rigorous. Students lacking adequate high school preparation should plan to spend the extra time (generally one or two semesters) necessary to make up deficiencies. These students are welcome in Moorpark College's engineering program and every effort will be made to aid in their successful completion of the program.

REQUIRED COURSES FOR THE MAJOR

California State University, Northridge		University of California, Los Angeles	
Engr 1	The Engineering Profession	Engr 1	The Engineering Profession
Engr 4	Engineering Graphics	Engr 4	Engineering Graphics
Engr 6	Computer Solutions to Engineering Prob.	Engr 6	Computer Solutions to Engineering Prob.
Engr 12	Engineering Statics & Strength of Materials	Engr 12	Engineering Statics & Strength of Materials
Engr 18	Engineering Materials	Engr 18	Engineering Materials
Math 25A/B/C	Calculus w/Analytic Geometry I, II, III	Math 25A/B/C	Calculus w/Analytic Geometry I, II, III
Math 35	Applied Differential Equations	Math 35	Applied Differential Equations
Ph 4	Mechanics of Solids & Fluids	Ph 4	Mechanics of Solids & Fluids
Ph 5	Electricity & Magnetism	Ph 5	Electricity & Magnetism
Ph 6	Heat, Sound, Optics & Modern Physics	Ph 6	Heat, Sound, Optics & Modern Physics
Chem 1A/B	General Chemistry	Chem 1A/B	General Chemistry

Civil Engineering students should have Engr 8A, Plane Surveying.

Chemical and Nuclear Engineers should contact the school to which they intend to transfer before completing this course sequence.

courses in engineering

Engr 1 - THE ENGINEERING PROFESSION

½ Unit

Prerequisite: None

1 hour lecture weekly (8 weeks)

A study of the engineering profession; its requirements, opportunities, and responsibilities. Presentations by members of the engineering profession. (F)
Accepted for credit, UC (all branches)
Accepted for credit, Cal Poly SLO

Engr 4 - ENGINEERING GRAPHICS WITH DESCRIPTIVE GEOMETRY

4 Units

Prerequisite: Major in Engineering or consent of instructor,
2 lecture, 6 hours laboratory weekly.

Introduction to elementary design, including experimental design of a structure, machine, circuit, or process. Graphic computations and analysis, including graphic calculus and nomography. Preparation of working drawings. Descriptive geometry.
Engr 4 with Engr 1 equivalent to Engr 107, CSUN
Accepted for credit, UC (all branches)
Equivalent to ET 141 Cal Poly SLO

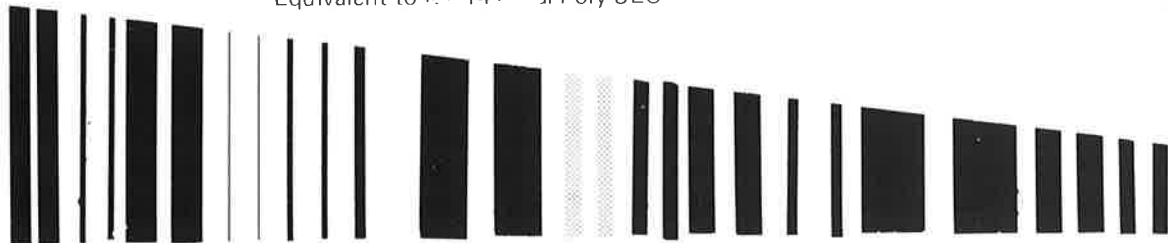

Engr 6 - COMPUTER SOLUTIONS TO ENGINEERING PROBLEMS **3 Units**

Prerequisite: Math 25A
3 hours lecture weekly

The use of digital computers in the solution of engineering problems, programming and programming languages. Emphasis will be placed on the solution of engineering problems using the FORTRAN and PL 1 programming languages.

Accepted for credit, UC (all branches)

Equivalent to Engr 200, CSUN

Equivalent to Engr 251, Cal Poly SLO

Engr 8A - SURVEYING **3 Units**

Prerequisites: Consent of instructor
2 hours lecture, 3 hours laboratory weekly

Affords the student the opportunity to make engineering measurements. The student studies in detail these three areas of land measurement - horizontal, angular and elevation. The theory of random errors, the probability curve and the theory of least squares is explained and applied.

Engr 8B - ADVANCED SURVEYING **3 Units**

Prerequisites: Engr 8A
2 hours lecture, 3 hours laboratory weekly

Lectures, laboratory instruction on vertical control, precise leveling; horizontal control; triangulation, trilateration, traverse; electronic distance measurements, least square adjustment of control survey observations; state coordinate system; astronomical observations for azimuth and latitude.

Engr 8A and 8B equivalent to AE 237, 238 and 239, Cal Poly SLO

Engr 12 - ENGINEERING STATICS AND STRENGTH OF MATERIALS **4 Units**

Prerequisites: Math 25A
4 hours lecture weekly

Vector algebra, equivalent force systems, free body diagrams and equilibrium, structural mechanics, behavior of deformable solids, stress and strain tension, compression, flexure, torsion, beams, columns, statically indeterminate problems, multiaxial stresses, theories of strength.

Equivalent to Engr 240, CSUN

Equivalent to ME 205 or 211 Cal Poly SLO

Engr 18 - ENGINEERING MATERIALS **3 Units**

Prerequisites: Chem 1B, Ph 5
3 hours lecture weekly

Application of basic principles to the selection and use of engineering materials; analysis of the internal structures of materials and dependence of properties upon these structures; the study of the behavior of materials in service.

Equivalent to either WM 306 or WM 335, Cal Poly SLO

Accepted for credit UC (all branches)

Equivalent to Engr 227 if 226L is taken after transfer, CSUN

Engr 45A - SLIDE RULE **1 Unit**

Prerequisites: None
2 hours lecture weekly (2nd 8 weeks)

Use of all 33 scales of a Log Log Decitrig Slide Rule; mathematical principles involved in the construction and use of the various scales. (Co-numbered Math 45A)

Engr 45B - SMALL COMPUTERS AND CALCULATORS

1 Unit

Prerequisites: Knowledge of basic algebra (high school algebra or Math 1)
2 hours lecture weekly (2nd 8 weeks)

Use of calculator, plotter, other accessories. Programming also includes instruction in use of pocket electronic calculators. Emphasis is on "hands-on" experience. (Co-numbered Math 45B)

Faculty: Tom Harris, John Thomsen, Ray Hobson

engineering technology

APPLIED DESIGN TECHNOLOGY

The field of applied design includes Technicians, Draftsmen, and Engineering Aides performing tasks related to the design and preparation for manufacturing of mechanical and electromechanical products. Two options are offered: Mechanical Design and Industrial Design. The mechanical designer assists in the design of mechanical components and assemblies, while the industrial designer works in the preparation for manufacturer and sale of the products.

REQUIRED COURSES IN THE MAJOR

ET 1	Engineering Technology	Mechanical Option	
ET 2*	Mechanical Drafting	ET 31†	Mechanics
ET 3*	Graphics and Engineering Sketching	ET 32†	Strength of Materials
		ET 34	Hydraulics
ET 10A*	Electronics Drafting	Industrial Option	
ET 14*	Technical Illustration	Art 4A1	Color and Design
ET 30*	Technical Materials	Art 4B†	Color and Design
Math 7	College Algebra w/Trig.	Bus 37†	Marketing
Ph 11A/B	Technical Physics		
Engr 45A	Slide Rule		

*A student currently employed in the field may receive an In-service Certificate in APPLIED DESIGN TECHNOLOGY upon successful completion of the courses marked * and 6 additional units of General Education, for a total of 22 units.

††A student not currently employed in the field may receive a Pre-service Certificate in APPLIED DESIGN TECHNOLOGY upon successful completion of the courses marked * plus the courses marked either † or †† and 9 additional units in General Education, including 6 units of Hum 1A or 1B.

CONSTRUCTION TECHNOLOGY

The construction industry has an ever present need for the technicians and draftsmen to do detail design, surveys, estimating, and inspection. They work closely with Architects, Civil Engineers and Contractors to assure safe and economical construction. The Construction Technology program trains technicians and draftsmen for these positions.

REQUIRED COURSES IN THE MAJOR

ET 1	Engineering Technology	ET 32	Strength of Materials
ET 2 or	Mechanical Drafting	ET 34	Hydraulics
ET 3	Graphics and Engineering Sketching	Engr 8A	Plane Surveying
ET 15	Civil Engineering Drafting	Ph 11A	Technical Physics
ET 16	Residential Construction Drafting	Math 2	Fundamentals of Geometry
ET 17	Commercial Construction Drafting	Math 3	Intermediate Algebra
ET 30	Technical Materials	Math 45A	Slide Rule
ET 31	Mechanics		

ELECTRONICS ENGINEERING TECHNOLOGY

Technological developments in the electronics and space industries have resulted in an increased number of job opportunities for individuals who have a technical education. This education must include the development of manipulative skills and the acquiring of technical knowledge through courses of instruction. Programs with this emphasis are presently available in the areas of electronics.

REQUIRED COURSES IN THE MAJOR

California State College, Long Beach

ET 20A	Basic Electronics: DC
ET 20B	Basic Electronics: AC
ET 20C	Solid State Devices
ET 28	Electronic Management
ET 10A/B	Electronic Drafting
Math 16A	Applied Calculus
Ph 11A/B	Technical Physics

California State Polytechnic Univ.

ET 20A	Basic Electronics: DC
ET 20B	Basic Electronics: AC
ET 20C	Solid State Devices
ET 28	Electronic Management
ET 10A/B	Electronic Drafting
Math 16A	Applied Calculus
Ph 11A/B	Technical Physics

courses in engineering technology

ET 1 - ENGINEERING TECHNOLOGY

½ Unit

Prerequisites: None
1 hour weekly (8 weeks)

An introductory course describing the requirements, opportunities, and responsibilities of technicians in the various fields of engineering and technology. Members of the profession will speak. (F)
Accepted for credit, Cal Poly SLO

ET 2 - MECHANICAL DRAFTING

3 Units

Prerequisites: None.
2 hours lecture, 3 hours laboratory weekly.

An introduction to drafting and graphic practice. Use and care of drafting equipment and instruments; lettering, theory of orthographic projection, pictorial drawings, sketches, working drawings. Prerequisite to all drafting and design courses. Designed to satisfy general education fine arts requirement. (F)
Equivalent to ET 131, Cal Poly SLO

ET 3 - GRAPHICS AND ENGINEERING SKETCHING

3 Units

Prerequisite: ET 2 or consent of instructor.
2 hours lecture, 3 hours laboratory weekly

Advanced orthographic projection: auxiliaries, sections, dimensioning, working drawings, charts, scales, perspective drawings, and freehand sketching.
Equivalent to either ET 142 or ET 151, Cal Poly SLO

ET 5 - BASIC ELECTRICITY

3 Units

Prerequisites: None
2 hours lecture, 3 hours laboratory weekly

This course presents the fundamentals of electrical circuits especially as used in technical equipment. The lecture sessions will present basic theory for motor circuits, lighting circuits, control circuits, etc. The laboratory work will complement the lecture with actual testing and troubleshooting of typical equipment such as motor operated equipment, light control circuits, etc.

ET 6AB - BASIC ELECTRONICS FOR FCC LICENSING**3-3 Units**

Prerequisites: ET 5 or ET 20A/B
3 hours lecture weekly.

Basic electronics circuits pertaining to radio and television broadcasting. Intended to prepare the student for the series of Federal Communications Commission examinations eventually leading to the first radio telephone operators license. (Co-number: Broadcasting 6A/6B, Journ 6A/B)

ET 10A/B - ELECTRONICS DRAFTING**3-3 Units**

Prerequisites: Mechanical Drafting or consent of instructor,
ET 10A for 10B
2 hours lecture, 3 hours laboratory weekly

ET 10A – Review of basic drafting as applied to electronics. Practice and development of skills in drawing symbols, block diagrams and schematic diagrams. Students will have an opportunity to redesign circuit diagrams.

ET 10B – Practice and development of advanced drafting work such as printed circuits, wiring diagrams, mechanical construction and special diagrams.
Equivalent to either EE 146 or EL 146, Cal Poly SLO

ET 14 - TECHNICAL ILLUSTRATION**3 Units**

Prerequisites: ET 2 or consent of instructor.
2 hours lecture, 3 hours laboratory weekly.

Preparation of technical illustrations to meet the standards of industry; drawings from blueprints, technical orders and freehand sketches, technical aspects of preparing work for reproduction; axonometric and perspective projection.
Equivalent to IT 245, Cal Poly SLO

ET 15 - CIVIL ENGINEERING DRAFTING**3 Units**

Prerequisites: ET 2 or equivalent or consent of instructor.
2 hours lecture, 3 hours laboratory weekly.

Computations and procedures peculiar to construction engineering office activities; maps and land descriptions; highway design procedures; water supply and sewer design; quantities and estimates; structures.
Accepted for credit, Cal Poly SLO

ET 16 - RESIDENTIAL CONSTRUCTION DRAFTING*3 Units**

Prerequisites: ET 2 or equivalent or consent of instructor.
2 hours lecture, 3 hours laboratory weekly.

Design and drafting of residential construction with consideration given to cost, location, client needs, and available materials. Preparation of complete working drawings. Includes field trips to construction sites. Appropriate codes are studied.

ET 17 - COMMERCIAL CONSTRUCTION DRAFTING*3 Units**

Prerequisites: ET 2 or equivalent or consent of instructor.
2 hours lecture, 3 hours laboratory weekly.

Design and drafting of commercial construction with consideration given to cost, location, client needs, and available materials. Preparation of complete working drawings. Includes field trips to construction sites. Appropriate codes are studied.

* ET 16 and 17 are equivalent to Arch 231-32 at Cal Poly, SLO upon review of the student's portfolio.

ET 20A - BASIC ELECTRONICS: DC**4 Units**Prerequisites: Basic Algebra; Concurrent Math 2, 3 or 7,
ET 51

3 hours lecture, 3 hours laboratory weekly

Passive D.C. circuit theory. Use of Ohm's and Kirchhoff's laws to solve simple D.C. circuit problems. Application of basic theorems, such as equivalent circuit, for solving more complex circuits. The D.C. characteristics of resistors, inductors and capacitors will be studied. Laboratory work provides practical applications of theoretical relationships.

ET 20B - BASIC ELECTRONICS: AC**4 Units**

Prerequisites: ET 20A, ET 51

3 hours lecture, 3 hours laboratory weekly

Passive circuit response to A.C. signals. Use of Ohm's and Kirchhoff's laws in A.C. circuits. The A.C. response of circuits with resistance, reactance and impedance. Laboratory work emphasizes practical aspects of A.C. relationships.

ET 20C - SOLID STATE DEVICES**5 Units**

Prerequisites: ET 20B

4 hours lecture, 3 hours laboratory weekly

Active electronic circuits. Comparison of linear and nonlinear systems. Gain; frequency response; principles of feedback. Solid state and vacuum devices. Device application; small signal amplifiers; power amplifiers; oscillators; special purpose applications. Laboratory emphasizes application of active circuit theory.

ET 20D - PULSE AND LOGIC CIRCUITS**5 Units**

Prerequisites: ET 20C (ET 20D will be listed as ET 20CX in the Fall 1973 Schedule)

4 hours lecture, 3 hours laboratory weekly

Analysis of pulse circuits; transient AC circuits; waveshaping circuits; switching circuits and oscillators; flip-flops; logic circuits; memory; Boolean Algebra. Laboratory will emphasize physical design and operation of pulse circuits. Equivalent to ET 232, Cal Poly SLO

**ET 22A/B - DIRECTED STUDIES IN ENGINEERING
TECHNOLOGY****1-3/1-3 Units**Prerequisites: A course in the specific field and the consent of
the instructor and Division Chairman

1-3 hours tutorial weekly

Designed for selected students who are interested in furthering their knowledge of technology on an independent study basis. Assigned problems will involve library, laboratory and field. Maximum of 6 units. Accepted for credit, Cal Poly SLO

ET 28 - ELECTRONIC MEASUREMENTS**3 Units**

Prerequisites: ET 20B (or concurrent enrollment)

2 hours lecture, 3 hours laboratory weekly

Theory and practice in the use of laboratory equipment used to test electronic devices and circuits. Typical tests are for gain, frequency response, frequency and time measurement; component and circuit evaluation, calibration of electronic test equipment. Laboratory work emphasizes the use of electronic measuring equipment and also the design of measurement systems to obtain specified information. Equivalent to EL 113, EL 153, Cal Poly, SLO

ET 30 - TECHNICAL MATERIALS**3 Units**

Prerequisites: None
3 hours lecture weekly

Introduction to the properties of materials including physical properties, limitation, design considerations, and measurement procedures.
Accepted for credit, Cal Poly SLO

ET 31 - MECHANICS**3 Units**

Prerequisite: Math 2 or concurrent enrollment
3 hours lecture weekly

A non-calculus course relating to the principles of plane statics and dynamics and their application to engineering problems; force systems, equilibrium conditions, force analysis of structures, friction, fluid statics, kinematics in plane motion.
Accepted for credit, Cal Poly SLO

ET 32 - STRENGTH OF MATERIALS**3 Units**

Prerequisite: ET 31
3 hours lecture weekly

Principles of applied mechanics of materials, utilizing basic mathematics in stress-strain concepts, beam analysis, joints and connections, and stress analysis.
Accepted for credit, Cal Poly SLO

ET 34 - HYDRAULICS**3 Units**

Prerequisite: Math 2 or concurrent enrollment
3 hours lecture weekly

An introduction to the principles of hydrology and hydraulics with application of these principles to the design of engineering structures.
Accepted for credit, Cal Poly SLO

ET 36 - CONSTRUCTION COST ESTIMATING**3 Units**

Prerequisites: Math 1 and ET 35
3 hours lecture weekly

Principles and practices in making quantity surveys and labor estimates for construction projects. Three field trips.

ET 39 - CONSTRUCTION METHODS FOR HOMEOWNERS**3 Units**

Prerequisites: None
2 hours lecture, 3 hours laboratory weekly

Fundamentals of home improvement including plans and permits, patio slabs and covers, room additions and improvements. Techniques will be discussed, demonstrated and used by students during the lab sessions. Includes field trips.

ET 51 - MATHEMATICS FOR ELECTRONICS**3 Units**

Prerequisites: Basic Algebra
3 hours lecture weekly

Review and application of basic mathematical and algebraic skills to electronic circuit problems. Various methods of solution used for series and parallel circuits. Use of the slide rule in calculations.

For information regarding Work Experience credit in the Engineering Technology program, refer to Page 224 in this catalog.

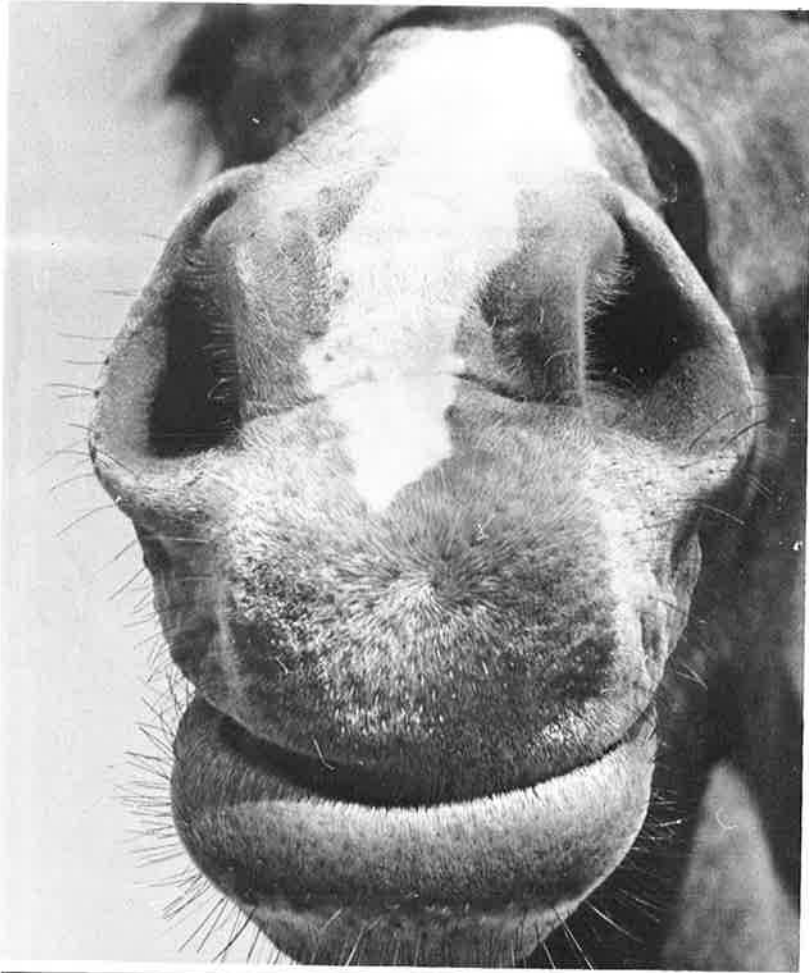

english

Faculty: Sidney Adler, Judith Allen, Richard Black, John Davie,
Richard Edwards, Hugo Ekback, John Hanft,
Diana Ho, Philip Houser, Taylor Klose,
Julie Landstad, Norman Mallory, Earl Owen,
Jon Popiel, Michael Seely, Pamela Sheridan,
Howard Siegel, Michael Strumpf, Sinclair Wall

Aristotle points out that history is concerned with facts, while philosophy is concerned with theory, and that it is in literature that precepts and concepts are viewed at once. Poets, writers of fiction, and dramatists are the pulse of the time. The field of literature is concerned with the psychology of the human condition, a sensitivity to the beauties, innuendoes, and ironies of language, and a critical understanding of great books. Classics have been defined as "Books that everyone wants to have read, but no one wants to read." In the study of literature, the great books are read and evaluated. Career opportunities include teaching, journalism, criticism, free-lance writing, radio and television writing, and trade publication work.

REQUIRED COURSES IN THE MAJOR

California State University, Northridge

Engl 1 Composition & Lit
Engl 15A/B English Literature
For Lan Foreign Language

University of California, Los Angeles

Engl 1 Composition & Lit
Engl 15A/B English Literature
For Lan Foreign Language

courses in english

Engl 1 - LITERATURE AND WRITTEN EXPRESSION

1½ Units

Prerequisites: Satisfactory placement score
3 hours lecture weekly for eight weeks

The objective of these English courses is to do the following:

1. To explore and analyze literature
2. To improve skills of self-expression and composition

The structure of these English courses gives the student these options:

1. The student may choose from any of the courses listed
2. The student may take a different instructor for each eight-week segment

Listed below are the current English 1 courses. Two English 1 courses are equivalent to the traditional English 1A course (3 units); four English 1 courses are equivalent to the traditional English 1A and 1B courses (6 units.) All courses listed are not offered each semester.

Accepted for credit, CSUN

1-A	Composition/Short Story
1-B	Composition/Poetry
1-C	Composition/Novel
1-D	Composition/Drama
1-E	Composition/Essay
1-F	Composition/English Focus; The following genre:

Rites of Passage - Deals with the literature of birth, puberty, and death now and in the past

Existentialism in Literature - Explores themes and topics as expressed in modern American and European literature.

Satire - Looks at the art of comic ridicule from examples both past and present.

Modern Poetry - Scrutinizes current trends in poetry and traces antecedents.

Christian Literature - Studies the Bible and other related works as truth, fact, and allegory.

Shakespeare - Studies a selection of Shakespeare's major works and relates them to the present.

Utopian Literature - Samples the ideals and hopeful plans of a select group of dreamers.

Of Men and the Sea - Explores man's relationship with the sea as represented in various plays, stories, and poems.

Mythology - Studies myth and its connection with man and society in major literature works.

Cinema - Explores examples of the cinematic art which you talk about, write about and mirror.

Comedy - Captures Falstaff, Natty Bumppo, Lenny Bruce and others as best it can.

Study and Writing of Song Lyrics

Women's Lit

Literature of War

Literature of American Indian - Studies the American Indian both past and present through his own scripture, fiction, poetry and song.

Literature of Risk - Grapples with man and woman facing marriage, patriotism, duty, death, and other rituals of life.

- Contemporary American Jewish Prose Fiction - Examines the relationship between form and meaning in the prose fiction of contemporary writers such as Bernard Malamud, Philip Roth, Saul Bellow, I.B. Singer, and Bruce J. Friedman.
- Recent American Fiction - Deals with literature of the Sixties, by men like Mailer, Updike, Roth, Cleaver, and Albee.
- Literature of the American West - Deals with the energies, idealisms, viciousness and generosity found in stories, poems, and novels about the settling of the west.
- Literature of Rural America - Studies in short works of fiction by Mark Twain, Sinclair Lewis, Sherwood Anderson, Willa Cather, William Faulkner and others. The life style, attitudes and values of small towns in America.
- Experimental Literature - Reading, discussion and writing about literature which deviates from the ordinary, traditional paths. Covers such writers as Franz Kafka, Donald Barthelme, and William Gass.
- Representative Women Writers - Reading, discussion and writing about such writers as Doris Lessing, Denise Levertov, Sylvia Plath, Joyce Carol Oates.
- Experimental Film - Viewing and analysis of student made and experimental films.
- Blues Literature - A treatment of tragic poetry and detailed examination of renowned Blues singers from the past to B.B. King.
- Beatles Literature - A detailed examination of the poetic lyrics of songs written by the Beatles.
- Soviet Russia - Study of fiction and poetry of 'Soviet realist' writing.
- Lit of the 60's - The writings of American authors of the generation of the 60's.
- Institutions in Lit - The literature of prisons, schools, mental hospitals, and others. Social, political and economic institutions as manifested in fiction and poetry.
- Sports Literature - Stories, poems, novels and non-fiction writing on competitive sports, sea-travel, and other individual and team endeavors.
- California Literature - The writings of Bret Hart, Mark Twain and others of California vintage.

NOTE: Humanities 6 and Humanities 5A and 5B, 8, 15 and 16 also offer English 1 credit. (See page .)

Engl 2 - PREPARATORY ENGLISH

3 Units

Prerequisite: Required of all students needing further work in written expression.

3 hours lecture weekly

Emphasis on English grammar, spelling, vocabulary building, sentence structure, and diction; frequent practice in writing short themes and in reading and analyzing selected essays. (Evenings and Summer only)

Engl 3 - WRITING WORKSHOP

5 Units

Prerequisites: Required of all students needing further work in written expression

4 hours lecture, 3 hours laboratory weekly.

Intensive practice in written expression with emphasis on major problems such as developing ideas, organization, and clarity of statement. Students will be expected to write regularly. Work will be evaluated on an individual basis.

Engl 4A/B - ENGLISH AS A SECOND LANGUAGE

3-3 Units

Prerequisites: None

2 hours lecture, 3 hours laboratory weekly

Identifies areas of weakness in speech, writing, reading, vocabulary, spelling for students for whom English is not the principle language. Strengthens these areas so that the student will be capable of communicating well in English. Some emphasis will also be placed on American customs.

Accepted for credit, UC (all branches)

Engl 10A - CREATIVE WRITING

3 Units

Prerequisite: English 1 or consent of instructor

3 hours lecture weekly

A writing workshop designed to concentrate on the techniques of writing fiction; practice in writing original works; discussion and analysis of students' writings.

Accepted for credit, CSUN

Accepted for credit, UC (all branches)

Engl 10B - CREATIVE WRITING

3 Units

Prerequisites: English 1 or consent of instructor

3 hours lecture weekly

A writing workshop designed to concentrate on the techniques of writing poetry; practice in writing original works; discussion and analysis of students' writings.

Engl 11 - RADIO-TELEVISION WRITING

3 Units

Prerequisite: Engl 1 or consent of instructor

3 hours lecture weekly

This course deals with the preparation and analysis of dramatic scripts, program formats, public service announcements, local news, commercials, continuity, discussion programs, special events, talks and interviews. Training is given in the fundamentals of script format, professional methods, and the ethics and restrictions involved in the broadcasting medias. (Co-number Broad 5.)

Accepted for credit, UC (all branches)

Accepted for credit, CSUN

Engl 13 - MAJOR AMERICAN WRITERS

3 Units

Prerequisite: Engl 1

3 hours lecture weekly.

Reading from the works of Emerson to Le Roi Jones, including Thoreau, Whitman, Twain, Crane, Faulkner, Hemingway, and selected modern poets.

Accepted for credit, UC (all branches)

Accepted for credit, CSUN

Engl 15A/B - SURVEY OF ENGLISH LITERATURE**3-3 Units**

Prerequisite: Engl 1 as required by transfer institution.
3 hours lecture weekly.

First semester--English literature in its cultural framework from Anglo-Saxon times to the Romantic Period.

Second semester--English literature in its cultural framework from the rise of Romanticism to the present.

Accepted for credit, UC (all branches)

Equivalent to Engl 258-259, CSUN

Engl 17 - SHAKESPEARE**3 Units**

Prerequisite: Engl 1

3 hours lecture weekly.

A survey of twelve plays, including romantic comedies, chronicles, tragedies, "dark" comedies, and romances; lectures; critical papers, and class discussions.

Accepted for credit, UC (all branches)

Accepted for credit, CSUN

Engl 18 - THE MODERN AMERICAN NOVEL**3 Units**

Prerequisites: Engl 1

3 hours lecture weekly.

An analysis of structure and meaning in the works of Dreiser, Hemingway, Dos Passos, Faulkner, Lewis, Wolfe, Bellow, Ellison, Malamud, and I.B. Singer. Written and oral presentations will supplement lectures and classroom discussions.

Accepted for credit, UC (all branches)

Accepted for credit, CSUN

Engl 19 - INTRODUCTION TO SHORT STORY**3 Units**

Prerequisite: Eligibility for English 1

3 hours lecture weekly.

The form and meaning of short-stories through intensive analysis of structure and meaning in selected American, British and continental examples.

Accepted for credit, UC (all branches)

Accepted for credit, CSUN

Engl 21 - CONTEMPORARY NOVELS**3 Units**

Prerequisites: English 1

3 hours lecture weekly

Reading and analysis of post-World War II novels, American and foreign, selected in view of their popularity as well as their innovative importance and literary quality.

Accepted for credit, CSUN

Engl 22A/B - DIRECTED STUDIES IN ENGLISH**1-3/1-3 Units**

Prerequisite: A course in the specific field and the consent of the instructor and division chairman.

1-3 hours tutorial weekly.

Designed for selected students who are interested in furthering their knowledge of English on an independent study basis. Assigned problems will involve library, laboratory, and field work. Maximum of 6 units.

Maximum credit 3 units, CSUN

Engl 25 - PLAYWRITING**3 Units**

Prerequisites: None
3 hours lecture weekly

Designed for the student to develop his skills in writing for the theatre with a possible opportunity of production. (Co-numbered ThA 25)
Accepted for credit, UC (all branches)

**Engl 27 - CONTEMPORARY FRENCH LITERATURE
IN TRANSLATION****3 Units**

Prerequisites: None
3 hours lecture weekly

Readings in contemporary French literature (Camus, Satre, Ionesco, Proust).
(Co-number, French 4)
Accepted for credit, CSUN

Engl 28 - HISPANIC CULTURE AND CIVILIZATION**3 Units**

Prerequisites: One year college Spanish or reading
ability in Spanish
3 hours lecture weekly

Reading and discussion in Spanish of the civilization and culture of the Spanish speaking countries, emphasizing one or two countries each semester. (Co-number, Span 4)

Engl 30 - MASTERPIECES OF WORLD LITERATURE**3 Units**

Prerequisite: Engl 1
3 hours lecture weekly.

A survey of representative authors from the time of Homer to the Renaissance, with intensive study of selected Greek, Roman, Medieval, and Renaissance masterpieces.
Accepted for credit, UC (all branches)
Accepted for credit, CSUN

Engl 31 - MASTERPIECES OF WORLD LITERATURE**3 Units**

Prerequisite: Engl 1
3 hours lecture weekly.

A survey of major literature from the Renaissance to the present, including such authors as Locke, Moliere, Rousseau, Goethe, Emerson, Tolstoi, Ibsen, and Mann.
Accepted for credit, UC (all branches)
Accepted for credit, CSUN

Engl 35A - SURVEY OF AMERICAN LITERATURE**3 Units**

Prerequisite: Engl 1
3 hours lecture weekly.

Significant American writers from the early seventeenth century to 1800, with emphasis on the intrinsic political, social, and intellectual trends of the periods they represent.
Accepted for credit, UC (all branches)
Accepted for credit, CSUN

Engl 35B - SURVEY OF AMERICAN LITERATURE

3 Units

Prerequisite: Engl 1
3 hours lecture weekly.

Significant American writers from 1800 to the present, with emphasis on the intrinsic political, social, and intellectual trends of the periods they represent.

Accepted for credit, UC (all branches)

Accepted for credit, CSUN

Engl 39A/B - MAJOR CIVILIZATIONS THROUGH DRAMA

3-3 Units

Prerequisites: None
2 hours lecture, 3 hours laboratory weekly

The tribal age, the age of cities, and the development of modern history to be recreated through research and produced in plays. A sense of history to be developed out of creative experiences based on historical study of the Greek, the Roman, Medieval, and the modern.

Engl 40 - WRITING RESEARCH PAPERS

1½ Unit

Prerequisite: Consent of instructor
3 hours lecture weekly (8 weeks)

Instruction will be given on all phases of preparing a research paper. Such problems as selecting, framing and narrowing a topic, sequencing and outlining, data collection and presentation, bibliography preparation, documentation, argument and logic will be discussed and explored. Students will be expected to complete a research paper during the course.

**Engl 45 - MEXICAN-AMERICAN LITERATURE
IN ENGLISH**

3 Units

Prerequisite: Satisfactory score on placement test
or consent of instructor.
3 hours lecture weekly.

Critical analysis in seminar form of Mexican-American literature. Concern is to present a point of view from the artistic eyes of the Mexican-American. Discussions will emphasize a cross cultural examination of poetry, prose, fiction and non-fictional works. The class will have an opportunity to experience and discuss pertinent ideas and feelings which best lend realism to the literature in question.

Equivalent to Mex-Amer. 201, CSUN

Accepted for credit, UC (all branches)

Engl 46 - AFRO-AMERICAN LITERATURE

3 Units

Prerequisite: None
3 hours lecture weekly.

Critical analysis in seminar form of Afro-American literature. Concern is to present a point of view from the artistic eyes of the Afro-American. Selected major figures from both the 19th and 20th centuries will be covered, with emphasis given to the most recent authors. The class will have an opportunity to experience and discuss pertinent ideas and feelings which best lend realism to the literature in question.

Equivalent to Afro-American 230, CSUN

Accepted for credit, UC (all branches)

Engl 47 - MAGAZINE EDITING**3 Units**

Prerequisites: Engl 1 or consent of instructor
2 hours lecture, 3 hours laboratory weekly

This is a course in the analysis, development, composing and layout of magazines or similar publications. Emphasis is given to coordinating feature stories and related articles with attractive pictorial displays. Instruction is also given in the graphic arts as related to the magazine production. (Co-numbered Journ 11A/B)

Engl 48A/B - COMMUNICATION SKILLS PRACTICUM**1-3 Units**

Prerequisites: Permission of instructor
6 - 18 hours weekly

During the first year, on-the-job training without financial compensation in the Communication Skills Center as an instructor's aide, under the continuous direction and supervision of a college English/Reading instructor. Prior to enrollment in the course, the student must meet with the instructor for approval and assignment to this class and must pass a basic proficiency test in Communication Skills.

For information regarding Work Experience credit in the English program, refer to Page _____ in this catalog.

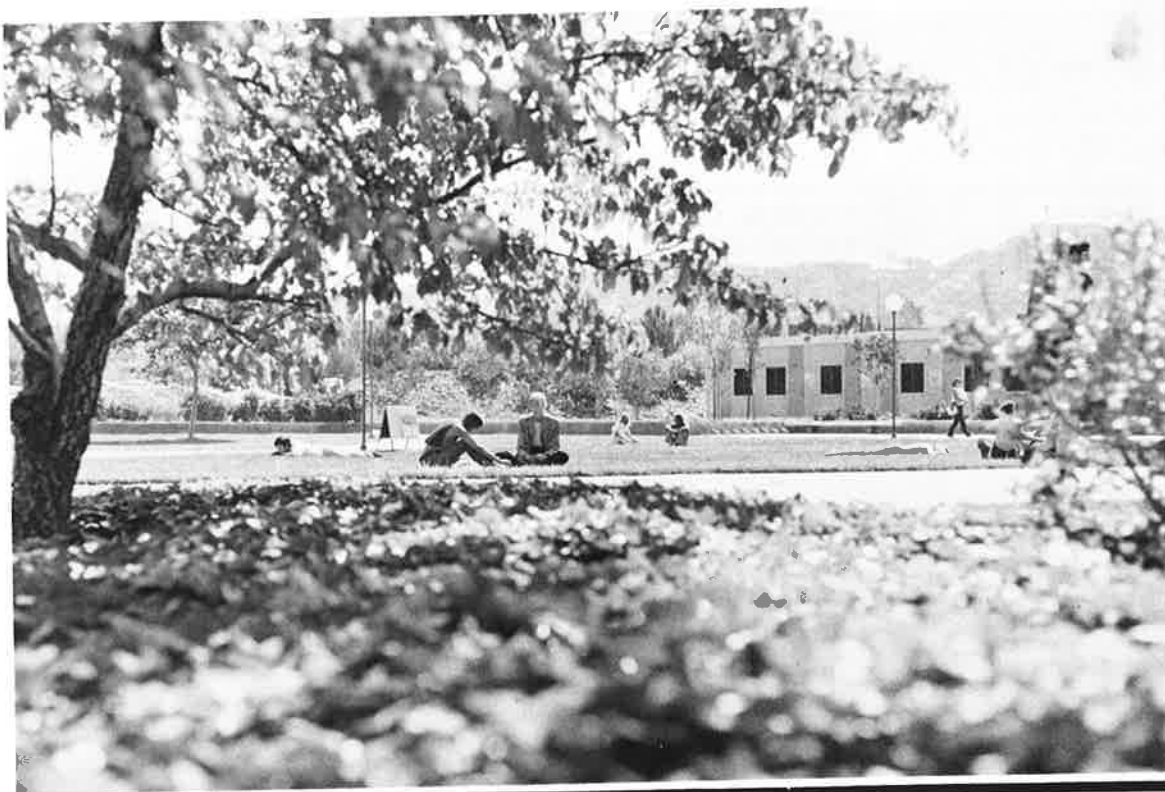

environmental science

Faculty: Byron Edde, Robert Miller, Jack Reynolds,
Eugene Berg

courses in environmental science

Env Sci 1 - ENVIRONMENTAL SCIENCE 4 Units
Prerequisites: Satisfactory score on Placement Test
3 hours lecture, 3 hours laboratory weekly

A discussion of current problems relating to physical and biological science with emphasis on those problems that deal with man and his environment, including such topics as energy resources, food, populations, pesticides, water, air and weather. Students will work with equipment used in fields of pollution. (Physical Science credit)
Accepted for credit, CSUN
Accepted for credit, UC (all branches)

Env Sci 2 - ENVIRONMENT AND MAN 4 Units
Prerequisites: Satisfactory score on Placement Test
3 hours lecture, 3 hours laboratory weekly

Relationships between man and his environment in an industrialized culture. Emphasis is upon the biological principles involved in human ecology. Living systems/energy use; man's effect upon the land, noise impact on organism response, conservation, recreation and niche needs are main tonics.
Accepted for credit, UC (all branches)
Accepted for credit, CSUN

Env Sci 30 - ENVIRONMENTAL STUDIES FOR TEACHERS 2 Units
Prerequisites: None
2 hours lecture weekly

An introductory course in environmental studies covering topics which include basic ecology, population, food and nutrition, water supply and water pollution, heavy metals, radiation, solid wastes and pesticides. Emphasis on classroom demonstrations and student projects. It can provide elementary and secondary teachers with the knowledge necessary for presenting studies in the human environment and/or it can serve as a general education science option.

courses in environmental technology

Env Tech 10A - WATER DISTRIBUTION SYSTEMS I 3 Units
Prerequisites: None
3 hours lecture weekly

Introduction to water distribution systems, Water sources and quality; definitions; water systems characteristics; operational mathematics; pipe installation and maintenance; meters; pumps and motors; safety; public relations. Prepares student for American Water Works Association Grade IV examination.

Env Tech 10B - WATER DISTRIBUTION SYSTEMS II **3 Units**
 Prerequisites: Env Tech 10A or AWWA Grade IV Certificate
 3 hours lecture weekly

Intermediate water distribution systems; designed to prepare the student for the AWWA Grade III Distribution Systems Operator's examination.

Env Tech 10C - WATER DISTRIBUTION SYSTEMS III **3 Units**
 Prerequisites: Env Tech 10B or consent of instructor
 3 hours lecture weekly

Water distribution and testing. Emphasis is on the more advanced aspects of water distribution and testing. Layout of systems; planning; operation. Laboratory emphasizes the testing of potable water including chemical and biological assays. Prepares the student for the AWWA Grade II Distribution Systems Operator examination.

Env Tech 10C - ADVANCED WATER DISTRIBUTION SYSTEMS **3 Units**
 Prerequisites: Env Tech 10C or consent of instructor
 3 hours lecture weekly

Water System management. Advanced planning; budgeting; procurement; personnel relations; public relations. Prepares the student for the AWWA Grade I Distribution Systems Operator examination.

For information regarding Work Experience credit in the Environmental Technology program, refer to Page 224 in this catalog.

escrow

The Moorpark College Escrow Program prepares the student for employment in the growing field of Escrow. It provides qualifications for openings in Escrow Departments in Banks, Savings and Loans, private Escrow offices and similar establishments. Students can earn an A.A. degree in Escrow as well as an Escrow Certificate. The Certificate Program is approved by and offered in cooperation with the California Escrow Association.

REQUIRED COURSES IN THE MAJOR

Escrow 1*	Principles of Escrow
Escrow 2*	Escrow Practice
Escrow 3*	Escrow Case Problems
Real Estate 91*	Real Estate Principles
Real Estate 92*	Legal Aspects of RE
Real Estate 95*	Real Estate Finance
Business 44+	Business Math
Business 39+	Business Communications
Business 3	Applied Accounting
Business 30	Introduction to Business
Hum 1A/B	Man in Society

*A student employed in the field may receive an In-service Certificate in ESCROW upon successful completion of the courses marked * and 6 additional units in General Education, for a total of 24 units.

+A student not currently employed in the field may receive a Pre-service Certificate in ESCROW upon successful completion of the courses marked * plus the course marked + and 9 additional units in General Education, including 6 units of Hum 1A or Hum 1B, for a total of 33 units.

courses in escrow

Escrow 1 - PRINCIPLES OF ESCROW

3 Units

Prerequisites: None
3 hours lecture weekly

A basic course in the Methods and Techniques of escrow procedure for various types of business transactions with emphasis on real estate. This course is designed to introduce the student to the field of escrow.

Escrow 2 - ESCROW PRACTICES

3 Units

Prerequisites: Escrow 1 or consent of instructor
3 hours lecture weekly

An advanced course covering more unusual and different types of escrows and evaluating possible solutions.

Escrow 3 - ESCROW CASE PROBLEMS

3 Units

Prerequisites: Escrow 2
3 hours lecture weekly

Further study of more unusual and difficult types of escrows. Actual case problems are presented and discussed. Conflicts and disputes in escrows are studied.

For information regarding Work Experience credit in the Escrow program, refer to Page 224 in this catalog.

fire science

Faculty: Jack Fleming, Coordinator

This responsible and life-saving work is in demand in many communities. The current program provides training to meet this demand. Class sessions may be repeated each week to adjust to the working hours of the fire protection personnel.

REQUIRED COURSES IN THE MAJOR

- FSc 91 Introduction to Fire Science
- ✓ FSc 92 Fundamentals of Fire Prevention
- ✓ FSc 94 Hazardous Materials I
- FSc 97 Fire Hydraulics
- ✓ FSc 98 Building Construction for Fire Protection
- ✓ FSc 99 Fire Company Organization and Management

A student currently employed in the field may receive an In-Service Certificate in FIRE SCIENCE upon successful completion of the above Fire Science courses, except FSc 91, and 6 additional units in General Education, for a total of 21 units.

A student not currently employed in the field may receive a Pre-Service Certificate in FIRE SCIENCE upon successful completion of the above FSc courses and FSc 100, Fire Apparatus and Equipment, and 9 additional units in General Education, including 6 units of Hum 1A or Hum 1B, for a total of 30 units.

FSc 50 - FIRE SCIENCE INSTITUTE

1 Unit

Prerequisites: Fire Science Major, Fire Service Personnel
17 hours lecture weekly

A short term lecture/workshop series on specialized fire science technology designed for fire service personnel.

FSc 91 - INTRODUCTION TO FIRE SCIENCE

3 Units

Prerequisites: None
3 hours lecture weekly

An introduction to the Fire Service and Fire Protection; career opportunities in fire protection and related fields; history of fire protection; fire loss analysis, public, quasi-public and private fire protection services; specific fire protection functions; fire chemistry and physics.

FSc 92 - FUNDAMENTALS OF FIRE PREVENTION

3 Units

Prerequisites: FSc 91 or consent of instructor
3 hours lecture weekly

Organization and function of fire prevention; inspections; surveying and mapping procedures; recognition of fire and life hazards; engineering a solution of a fire hazard; enforcing the solution of a fire hazard; public relations as affected by fire prevention.

FSc 93 - FIRE FIGHTING TACTICS AND STRATEGY

3 Units

Prerequisites: FSc 91 and 92 or consent of instructor
3 hours lecture weekly

Principles of fire control through the utilization of manpower, equipment, and extinguishing agents on the fireground.

FSc 94 - HAZARDOUS MATERIALS I

3 Units

Prerequisites: FSc 91, 92 and 93 or consent of instructor
3 hours lecture weekly

An introduction to basic fire chemistry and physics. Problems of flammability as encountered by firefighters when dealing with fuels and oxidizers. Elementary fire fighting practices pertaining to hazardous materials in storage and transit.

FSc 95 - FIRE PROTECTION EQUIPMENT AND SYSTEMS

3 Units

Prerequisites: FSc 91, 92 and 93 or consent of instructor
3 hours lecture weekly

A study of portable fire extinguishing equipment; protection systems for special hazards; sprinkler systems; and fire detection and alarm systems.

FSc 96 - RELATED CODES AND ORDINANCES

3 Units

Prerequisites: FSc 91, 92 and 93 or consent of instructor
3 hours lecture weekly

Familiarization and interpretation of national, state and local codes; ordinances and laws which influence the field of fire prevention.

FSc 97 - FIRE HYDRAULICS**3 Units**

Prerequisites: FSc 91 or consent of instructor
3 hours lecture weekly

Review of basic mathematics; hydraulic laws and formulas as applied to the fire service; application of formulas and mental calculation to hydraulic problems; water supply problems; underwriters requirements for pumps.

FSc 98 - BUILDING CONSTRUCTION FOR FIRE PROTECTION**3 Units**

Prerequisites: FSc 91 and 92 or consent of instructor
3 hours lecture weekly

Fundamentals of building construction as it relates to fire protection. Classification by occupancy and types of construction with emphasis on fire protection features including: building equipment, facilities, fire resistive materials and high rise considerations.

FSc 99 - FIRE COMPANY ORGANIZATION AND MANAGEMENT**3 Units**

Prerequisites: FSc 91 and 92 or consent of instructor
3 hours lecture weekly

Review of fire department organization; planning, organizing and supervising to meet the needs of the fire department, with emphasis on the company officer's role.

FSc 100 - FIRE APPARATUS AND EQUIPMENT**3 Units**

Prerequisites: FSc 91, 92 and 93 or consent of instructor
3 hours lecture weekly

Fire apparatus design, specifications and performance capabilities; effective utilization of apparatus in fire service emergencies.

FSc 101 - RESCUE PRACTICES**3 Units**

Prerequisites: FSc 91, 92, 93 and 100 or consent of instructor
3 hours lecture weekly

Rescue problems and techniques; emergency rescue equipment; toxic gases; chemicals and diseases; radiation hazards; care of victims including emergency childbirth, respiration and resuscitation, extrication, and other emergency conditions.

FSc 102 - HAZARDOUS MATERIALS II**3 Units**

Prerequisites: FSc 19, 92, 93 and 94
3 hours lecture weekly

A second semester course in Hazardous Materials covering handling, identification, and fire fighting practices involving explosive, toxic, and radioactive materials in storage and transit.

FSc 103 - FIRE INVESTIGATION I

3 Units

Prerequisites: FSc 91, 92 and 93 or consent of instructor
3 hours lecture weekly

Determining causes of fires (accidental, suspicious and incendiary); types of fires; related laws; introduction to arson and incendiarism; recognizing and preserving evidence; interviewing witnesses and suspects; arrest and detention procedures, court procedures and giving court testimony.

For information regarding Work Experience credit in the Fire Science program, refer to Page 224 in this catalog.

Faculty: Philip Houser

french

With the growing interdependence of nations, persons with facility in foreign language are needed more than ever. Specialists work in such areas as anthropology, economics, political science, literature, and sociology. Still the principal area of employment is in teaching on the elementary, secondary and college levels. Other careers may be found in interpreting, translating, research, diplomacy and other government work, libraries, and the publishing business.

REQUIRED COURSES IN THE MAJOR

California State University, Northridge

Fr 1A/1B Elementary French
Fr 2A/2B Intermediate French

University of California, Santa Barbara

Fr 1A/1B Elementary French
Fr 2A/2B Intermediate French

courses in french

Fr 1A/B - ELEMENTARY FRENCH

4-4 Units

Prerequisite: For Fr 1A, consent of counselor; for Fr 1B, Fr 1A or
2 years of high school French with grades of C or better.
5 hours lecture, 1 hour laboratory weekly.

Intensive study of the French Language and culture; special emphasis will be given to the skills and knowledge necessary for speaking and writing French and the unique nature of the people and their history; the language laboratory will be used extensively in the class and students will be expected to arrange an additional hour of language lab time each week.

Equivalent to French 101 and 102, CSUN
Accepted for credit, UC (all branches)

Fr 2A/B - INTERMEDIATE FRENCH

4-4 Units

Prerequisite: For Fr 2A, Fr 1B or 3 years of high school French with grades of C or better; for Fr 2B, Fr 2A or 4 years of high school French with an equivalent fluency.

5 hours lecture, 1 hour laboratory weekly

Further study of spoken and written French and of French culture; development of ability to read with greater ease by study and discussion in French of representative literary works; continued emphasis on oral and written expression. All students will be expected to spend an additional hour of study per week in the language laboratory. (Fr 2A-F, Fr 2B-S)

Equivalent to French 201 and 202, CSUN

Accepted for credit, UC (all branches)

Fr 4 - CONTEMPORARY FRENCH LITERATURE IN TRANSLATION

3 Units

Prerequisites: None

3 hours lecture weekly

Readings in contemporary French literature (Camus, Sartre, Ionesco, Proust). (Co-Number Engl 27)

Fr 22A/B - DIRECTED STUDIES IN FRENCH

1-3/1-3 Units

Prerequisites: A course in the specific field and consent of instructor and Division Chairman

1-3 hours lecture weekly (tutorial)

Designed for selected students who are interested in furthering their knowledge of French on an independent basis. Assigned problems will involve library and field work. Maximum of 6 units.

Accepted for credit, UC (all branches)

Maximum 3 units credit, CSUN

(See English 1 offerings for courses covering French literature in English translation)

general studies

Gen St 1 - THE ART OF INVESTIGATION

3 Units

Prerequisites: Satisfactory score on Placement Test
3 hours lecture weekly

An interdisciplinary course intended to introduce students to the various investigative techniques employed by natural and social scientists and the arts. Students are provided with an opportunity to gain a working familiarity with some of the characteristic methodologies employed by investigators in these fields. Accepted for credit, UC (all branches)

Gen St 2 - METHODS OF CREATIVITY

3 Units

Prerequisites: Satisfactory score on Placement Test
3 hours lecture weekly

This course examines the scope of the senses. Student will discover their capacity for sensual response to their experiences. Special projects and creative methods and solutions to problems will also be explored. Humanities Group C credit.

Baccalaureate Level



geography

Faculty: Roger Boedecker, Joseph Glantz

Students interested in studying the earth and its peoples in their relationships and regional variations may enroll in courses which will permit them to become a major in geography. These courses allow the student to acquire a general background of these spatial relations and processes. Courses offered include both empirical and theoretical approaches in understanding geography at a variety of scales ranging from global to local. The underlying purpose of the program is to encourage analysis of why things and people are where they are.

REQUIRED COURSES IN THE MAJOR

California State University

Geog 1	Physical Geography
Geog 2	Cultural Geography
Geog 3	Geog of World Affairs

University of California, Los Angeles

Geog 1	Physical Geography
Geog 2	Cultural Geography

courses in geography

Geog 1 - ELEMENTS OF PHYSICAL GEOGRAPHY

3 Units

Prerequisite: Satisfactory score on placement test
3 hours lecture weekly.

A study of the physical elements of geography, hydrography, land forms, vegetation, and climate; their interrelationships, pattern of distribution on a world scale, and the mutual relationships which exist between man and his physical environment, including ecology and its social ramifications. Map reading and interpretation emphasized. Field trips will be required. (F)

Equivalent to Geog 101, CSUN

Accepted for credit, UC (all branches)

Geog 2 - ELEMENTS OF CULTURAL GEOGRAPHY

3 Units

Prerequisite: Satisfactory score on placement test.
3 hours lecture weekly.

Introduction to the broad field of geography—its objectives, principal divisions, basic principles, and applications to present-day world problems, understanding human society in relation to the earth environment with emphasis on the cultural elements; geographic analysis of the major world regions. Field trips will be required. (F)

Equivalent to Geography 150, CSUN

Accepted for credit, UC (all branches)

Geog 3 - GEOGRAPHY OF WORLD AFFAIRS

3 Units

Prerequisites: Satisfactory score on Placement Test or consent
of instructor
3 hours lecture weekly

A survey of world geography emphasizing the regions, people, and economic activities characteristic of the major political areas of the world. This course is designed for students who desire to improve their understanding of how world affairs are affected by the way man occupies the world.

Equivalent to Geog 181, CSUN

Geog 5 - INTRODUCTION TO METEOROLOGY

3 Units

Prerequisite: None
3 hours lecture weekly.

Introduction to meteorological phenomena; energy, atmospheric circulation, precipitation, storms. Interrelationships between land, sea and atmosphere. Introduction to meteorological instrumentation and reporting. Interpretation of data. Introduction to aviation weather, weather modification. (Co-number Phys Sci 5)

Equivalent to Geography 103, CSUN

Accepted for credit, UC (all branches)

Geog 5L - INTRODUCTION TO METEOROLOGY LABORATORY

1 Unit

Prerequisites: Phy Sc 5/Geog 5
Concurrent or consent of instructor
3 hours laboratory weekly

Laboratory to accompany Geog 5. Introduction to Meteorological observation; cloud identification, instrumentation; interpretation of weather charts and data; weather system identification and analysis. Field trips required. (CO-number Phy Sci 5L)

Geog 9 - ENVIRONMENTAL DESIGN: URBAN GEOGRAPHY **3 Units**

Prerequisites: Satisfactory score on Placement Test; a course in Political Science or Sociology

3 hours lecture weekly

A social science elective, general education course. Study and analysis of the process of urbanization. Population patterns, regional analysis, general land use patterns, and their inter-relationships as well as their correlations with the physical and cultural elements will be included. Emphasis will be on the principles and techniques of land-use planning in urban areas.

Equivalent to Urban Studies 250, CSUN

Accepted for credit, UC (all branches)

Geog 10 - GEOGRAPHY OF CALIFORNIA **3 Units**

Prerequisites: None

3 hours lecture weekly.

An examination of the inter-relationships between the physical and cultural elements of geography as they occur in California's diversity of landscapes. Special attention will be given to the local region. Field trips will be required.

Accepted for credit, CSUN

Accepted for credit, UC (all branches)

Geog 11 - TRAVEL GEOGRAPHY **3 Units**

Prerequisites: None

3 hours lecture weekly.

An examination of the various regions of the world in terms of their attractions, both natural and cultural, for travelers. Attention will be given to both well-known and little-known attractions. Context organization will be based on student interests and experiences.(S) Not designed for transfer.

Geog 13 - TWENTIETH CENTURY WORLD GEOGRAPHY **3 Units**

Prerequisites: None

3 hours lecture weekly.

Exploration of the world in the last third of the 20th Century. Emphasis on the where of what is happening in the world, people and events. Not designed for transfer. (F)

Geog 22 A/B - DIRECTED STUDIES IN GEOGRAPHY **1-3/1-3 Units**

Prerequisites: A course in the specific field with a recommending grade and consent of instructor and Division Chairman.

1-3 hours tutorial weekly.

Designed for selected students who are interested in furthering their knowledge of geography on an independent study basis. Assigned problems will involve library, laboratory, and field work. Maximum of 6 units.

Maximum credit allowed 3 units, CSUN



geology

Faculty: Dorothy Sarnecky

Geology is the science of the earth, and the student in this subject is engaged in one of the most fascinating of endeavors. Geologists study the earth's history, structure, and composition as revealed by rock formations and by animal and vegetable fossils. They search for fuels, minerals, and water supplies. The geologist may enter a career in such industries as mining and petroleum, work with such governmental agencies as the geological or geodetic surveys, or enter research or teaching.

REQUIRED COURSES IN THE MAJOR

Six courses in Geology plus additional Math/Science to equal 20 units are required for the A.A. degree.

All State Universities
All UC Campuses

Geol 21	Physical Geology	Plus any 2 or more of the following	Geol 21	Geology of California
Geol 2L	Physical Geology Lab		Geol 41	Geology of National Parks
or			Geol 51	Field Geology of So. Calif.
Geol 31	Rocks, Minerals, Maps		Geol 61	Environmental Geology
Geol 3	Historical Geology			
Geol 17A/B	Mineralogy			

courses in geology

Geol 2 - PHYSICAL GEOLOGY

Prerequisite: None
3 hours lecture weekly.

3 Units

Materials and structure of the earth; origin and development of land forms; principles and processes of Geology including erosion and sedimentation; volcanic, glacial and earthquake activity, introduction to oceanography. Field trips. For lab take Geo 2L (optional) (F,S)

Equivalent to Geology 101, CSUN
Accepted for credit, UC (all branches)

Geol 2L - PHYSICAL GEOLOGY LABORATORY

1 Unit

Prerequisite: Geol 2L or concurrent
3 hours lecture - laboratory weekly.

Identification of common minerals and rocks. Introduction to topographic, aerial and geologic maps. (Not open to students who have taken Geol 31) (F,S)
Equivalent to Geology 101L, CSUN
Accepted for credit, UC (all branches)

Geol 3 - HISTORICAL GEOLOGY

3 Units

Prerequisites: None
3 hours lecture weekly.

Geologic history of the earth and evolution of life as revealed in the fossil record, with emphasis on the North American continent, origin of the universe and continental drift theories; elementary problems in paleontology, stratigraphy, structure and geologic mapping. Field trips. (F,S - alternate semesters)
Equivalent to Geology 102, CSUN
Accepted for credit, UC (all branches)

Geol 17A/B - MINERALOGY-PETROLOGY

3-3 Units

Prerequisites: None
2 hours lecture, 3 hours laboratory weekly

Introduction to the six crystal systems; identification of 100 of the common metallic and non-metallic minerals and ores by physical methods, occurrence, origin and associations. Origin, occurrence and identification of 100 common igneous sedimentary and metamorphic rocks in hand and field specimens. Introduction to thin-section microscopy.
Accepted for credit, CSUN
Accepted for credit, UC (all branches)

Geol 21 - GEOLOGY OF CALIFORNIA

3 Units

Prerequisites: A previous course in Geology
3 hours lecture weekly.

Study of the geomorphic provinces of California, including topograph, structure, geologic history, lithology and mineral resources. Field project required. Field trips. (F,S - alternate semesters)
Accepted for credit, CSUN
Accepted for credit, UC (all branches)

Geol 22A/B - DIRECTED STUDIES IN GEOLOGY

1-3/1-3 Units

Prerequisites: Consent of instructor and Division Chairman
1-3 hours tutorial weekly.

Directed studies for Geology majors and minors, Maximum of six units.
3 units maximum accepted, CSUN
Accepted for credit, UC (all branches)

Geol 31 - ROCKS, MINERALS AND MAPS

2 Units

Prerequisites: None
2 hours lecture, 1 hour laboratory weekly.

Identification, classification, origin and occurrence of common rocks and minerals in hand and field specimens: The use and interpretation of topographic, aerial and geologic maps. All day field trips. (F,S)
Accepted for credit CSUN
Accepted for credit, UC (all branches)

Geol 41 - GEOLOGY OF THE NATIONAL PARKS AND MONUMENTS 3 Units

Prerequisites: None
3 hours lecture weekly.

Survey of the physical and historical geology of the national parks and monuments with emphasis on western America. Written report required. Field trips. Not open to students who have had Geol. 2. (F, S - alternate semesters)

Accepted for credit, CSUN
Accepted for credit, UC (all branches)

Geol 51 - FIELD GEOLOGY OF SOUTHERN CALIFORNIA 1-3 Units

Prerequisites: A previous course in geology and/or consent of instructor
Lecture and Field trip - variable

Field studies and discussion of geologic processes as exemplified at various localities. Time and place to be announced.

Geol 61 - ENVIRONMENTAL GEOLOGY 3 Units

Prerequisites: None
3 hours lecture weekly

Study of geologic hazards in the classroom and field. Application of geology to environmental problems such as landslides, earthquakes, floods, etc. Emphasis on local conditions.

Faculty: Jane Chapman

german

With the growing interdependence of nations, persons with facility in foreign language are needed more than ever. Specialists work in such areas as anthropology, economics, political science, literature, and sociology. Still the principal area of employment is in teaching on the elementary, secondary and college levels. Other careers may be found in interpreting, translating, research, diplomacy and other government work, libraries, and the publishing business.

REQUIRED COURSES IN THE MAJOR

California State University, Northridge
Ger 1A/1B Elementary German
Ger 2A/2B Intermediate German

University of California, Santa Barbara
Ger 1A/1B Elementary German
Ger 2A/2B Intermediate German

courses in german

Ger 1A/B - ELEMENTARY GERMAN 4-4 Units

Prerequisite: For Ger 1A, consent of counselor; for Ger 1B, Ger 1A or 2 years of high school German or an equivalent fluency.
5 hours lecture, 1 hour laboratory weekly

Intensive study of the German Language and culture; special emphasis will be given to the skills and knowledge necessary for speaking and writing German and the unique nature of the people and their history; the language laboratory will be used extensively in the class and students will be expected to arrange an additional hour of language lab time each week.

Equivalent to German 101 and 102, CSUN
Accepted for credit, UC (all branches)

Ger 2A/B - INTERMEDIATE GERMAN

4-4 Units

Prerequisite: For Ger 2A, Ger 1B or 3 years of high school German with grades of C or better or equivalent fluency; for Ger 2B, Ger 2A or 4 years of high school German.

5 hours lecture, 1 hour laboratory weekly

Further study of spoken and written German and of German culture; development of ability to read with greater ease by study and discussion in German of representative literary works; continued emphasis on oral and written expression. All students will be expected to spend an additional hour per week of study in the language laboratory.

Equivalent to German 201 and 202, CSUN

Accepted for credit, UC (all branches)

Ger 22A/B - DIRECTED STUDIES IN GERMAN

1-3/1-3 Units

Prerequisite: A course in the specific field and consent of the instructor and Division Chairman

1-3 hours lecture weekly (tutorial)

Designed for selected students who are interested in furthering their knowledge of German on an independent study basis. Assigned problems will involve library and field work. Maximum of 6 units. (F,S)

Accepted for credit, UC (all branches)

3 units maximum allowed, CSUN

(See English 1 offerings for courses covering German literature in English Translation.)

Faculty: Tanya Burke, John Gray,
Ray Hobson

graphic communications

With the printing industry anticipating a growth rate that will more than double, the field of Graphic Communications offers unlimited opportunity for those who qualify. Employment at all levels from technicians to management will be available in such areas as creative layout and design, advertising, sales, photography, lithography and bindery operations. Advancements in computer controlled equipment and chemical processes provide opportunities for the math and science oriented person as well.

REQUIRED COURSES IN THE MAJOR

GC 1	Intro to Graphic Communications	GC 6B	Advanced Process Camera
GC 2	Duplicating Processes	GC 6C	Color Separation Photography
or		GC 7	Stripping & Platemaking
GC 4	Advertising, Layout and Design Techniques	GC 8A	Lithography
GC 5A	Copy Prep & Composing Systems	GC 8B	Advanced Lithography
GC 6A	Process Camera	GC 9	Graphic Comm. Lab
		GC 11A	Screen Processes
		GC 15	Letterpress Composing and Printing

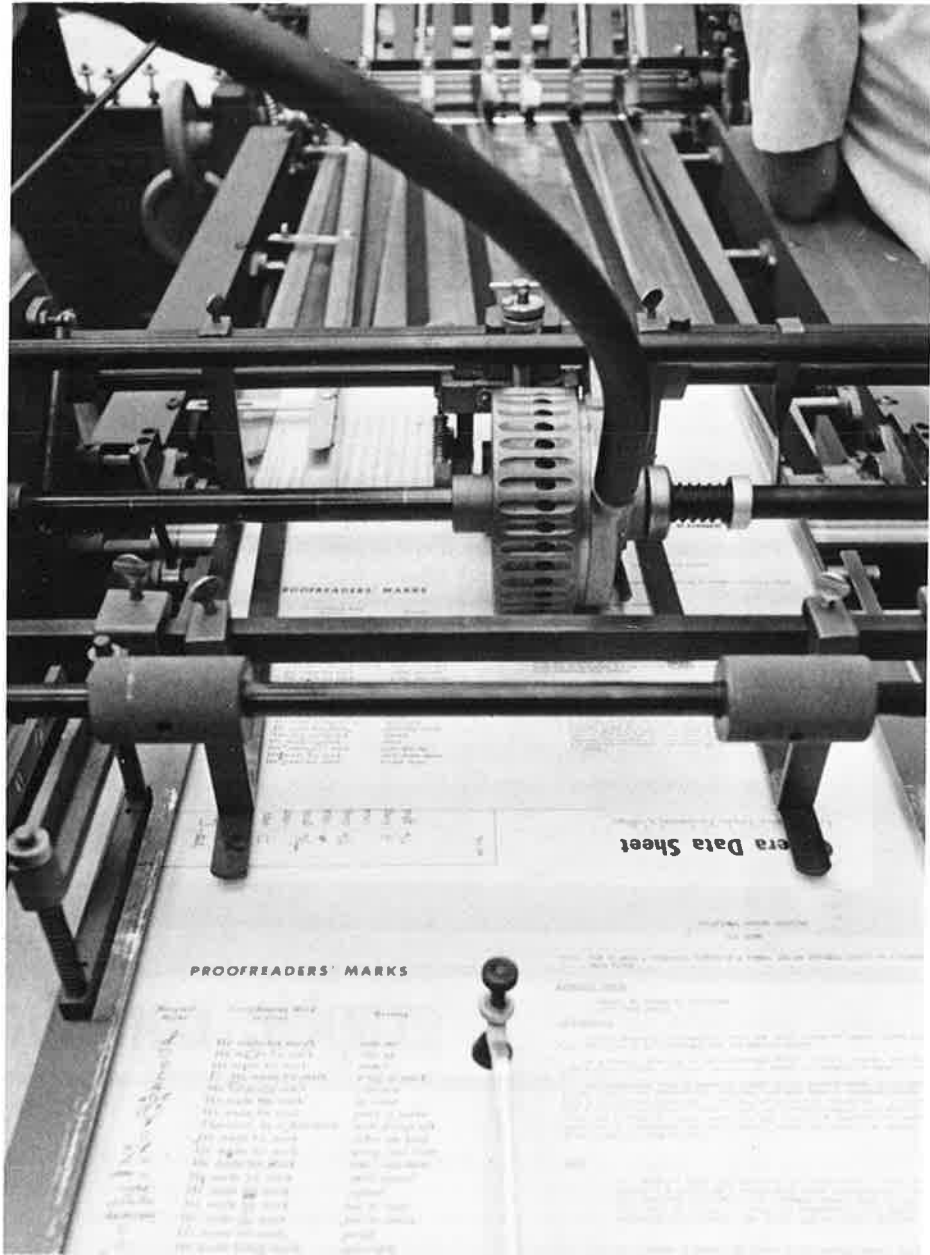

courses in graphic communications

GC 1 - INTRODUCTION TO GRAPHIC COMMUNICATIONS

3 Units

Prerequisites: None
3 hours lecture weekly.

An orientation to the concepts in Graphic Communications with an overview of printing practices, design, layout, composition, press work, binding, process camera, and related items.

Equivalent to GRC 101, Cal Poly SLO

GC 2 - DUPLICATING PROCESSES**2 Units**

Prerequisites: Satisfactory score on placement test.
6 hours laboratory weekly

Characteristics and operation of duplicators, including spirit, stencil, scanner, offset duplicators, thermofax, ozalid reproduction and dry copying. Practice in the use of multi-color duplication, and the preparation of overhead transparencies.

GC 4 - ADVERTISING LAYOUT AND DESIGN TECHNIQUES**3 Units**

Prerequisites: None
2 hours lecture, 3 hours laboratory weekly.

Fundamentals of layout and design for graphic reproduction including the principles of design, and the techniques of layout and paste-up. Preparation of line and tone copy for offset reproduction. Designing roughs and visuals and preparation of single and multi-color mechanicals for use in commercial and publication printing. Study of the point system, type identification and copy markup systems. (Co-numbered Journ 7)
Equivalent to GRC 122, Cal Poly SLO

GC 5A-B - COPY PREPARATION AND COMPOSING SYSTEMS**3,3 Units**

Prerequisites: GC 1, Bus 11B, and consent of instructor
2 hours lecture, 3 hours laboratory weekly.

Practical work in the operation of the IBM MT/SC cold-type setting machine, plus work with Varsity, composer and Headliner systems. Specific instruction is given in newspaper, textbook, magazine, and other commercial composing work.

GC 6A - PROCESS CAMERA**3 Units**

Prerequisites: GC 1 or consent of instructor
2 hours lecture, 3 hours laboratory weekly.

Characteristics of photographic materials for the graphic arts. Theory and practice in the use of gallery camera for the production of line and half-tone negatives, densitometry, sensitometry. Applications for special process screens.
Equivalent to GRC 227, Cal Poly SLO

GC 6B - ADVANCED PROCESS CAMERA**3 Units**

Prerequisites: GC 6A, Process Camera, or consent of instructor
2 hours lecture, 3 hours laboratory weekly.

Advanced theory and practice of the Gallery camera for the production of half-tone negatives, especially duotones and tritones, rescreening, advanced densitometry and sensitometry, introduction to retouching, dot etching and color separation photography.
Accepted for credit, Cal Poly SLO

GC 6C - COLOR SEPARATION PHOTOGRAPHY**3 Units**

Prerequisites: GC 6B or equivalent trade experience
2 hours lecture, 3 hours laboratory weekly

Equipment, materials, and techniques for color separation photography. Three and four color separations from opaque and transparent copy. Introduction to dot etching and color etching.

GC 7 - STRIPPING AND PLATEMAKING

3 Units

Prerequisites: GC 6A, Process Camera, or consent of instructor
2 hours lecture, 3 hours laboratory weekly.

Planning for lithographic press plates. Ruling, scribing, opaquing, and retouching negatives, preparation of supports for stripping, layout and assembly of stripped flats. Selection, care and making of pre-sensitized and deep etch lithographic plates. Proofing techniques.

Equivalent to GRC 228, Cal Poly SLO

GC 8A - LITHOGRAPHY

3 Units

Prerequisites: GC 1 or consent of instructor
2 hours lecture, 3 hours laboratory weekly.

Theory and practice in the use of single-color sheet-fed off set presses, Sheet feeders, printing units, inking units, dampening units and deliveries, Characteristics of paper and inks for offset photography.

Equivalent to GRC 229, Cal Poly SLO

GC 8B - ADVANCED LITHOGRAPHY

3 Units

Prerequisites: GC 8A, or consent of instructor
2 hours lecture, 3 hours laboratory weekly.

Survey of single and multi-color sheet fed offset presses. Emphasis in process color printing and precision control of inking and dampening. Practice in quality control.

Accepted for credit, Cal Poly SLO

GC 9 - GRAPHIC COMMUNICATIONS LABORATORY

1-2 Units

Prerequisites: Consent of instructor
3 6 hours laboratory weekly.

Practice in production of offset printing, planning, typesetting, copy preparation, camera, preparation of plates, presswork, bindery and finishing. Major emphasis on printing estimates.

Accepted for credit, Cal Poly SLO

GC 11A - SILK SCREEN PRINTING PROCESSES

2 Units

Prerequisites: GC 1 or consent of instructor
1 hour lecture, 3 hours laboratory weekly

Silk screen process reproduction methods with applications to industry and communications. Includes paper, tusche and glue, knife cut and photographic stencils, printing mediums, surfaces, and industrial applications such as printed circuits and packaging.

Equivalent to GRC 357, Cal Poly SLO

GC 11B - ADVANCED SILK SCREEN PRINTING PROCESSES

2 Units

Prerequisites: GC 11A or consent of instructor
1 hour lecture, 3 hours laboratory weekly

Advanced techniques of silk screen printing with emphasis on individual experiences. Exploration of production procedures. Creative, artistic utilization of the various screen stencils.

GC 15 - LETTERPRESS COMPOSING AND PRINTING

3 Units

Prerequisites: GC 1 or consent of instructor
2 hours lecture, 3 hours laboratory weekly

Keyboard and tape operation of linecasting machines. Use of teletypesetting machines, Ludlow, and miscellaneous hot type machines. Operation and maintenance of letterpress presses, imposition, lock-up, makeready, registration, and ink control. Analysis of rollers, inks and paper.

GC 22A/B - DIRECTED STUDIES IN GRAPHIC COMMUNICATIONS 1-3/1-3 Units

Prerequisites: A course in the specific field and the consent of
division chairman

1-3 hours tutorial weekly.

Designed for selected students who are interested in furthering their knowledge of graphic communications on an independent study basis. Assigned problems will involve library, laboratory and field. Maximum of 6 units.

For information regarding Work Experience credit in the Graphic Communications program, refer to Page 224 in this catalog.



health science

The curriculum for the Health Science major shown below is closely coordinated with the Health Science program at California State University, Northridge and is designed to prepare students for positions in allied health professions, public health agencies, voluntary agencies and school programs.

An 1	General Human Anatomy
Biol 2A/B	General Biology
Chem 1A/B	General Chemistry
or	
Chem 12, 13	Elementary Chem I, II
HS 1	Health & Society
Math 12	College Algebra w/Business Applications
Micro 1	Principles of Microbiology
Phys 1	Introduction to Human Physiology
Psych 1A	Introduction to Psychology
Soc 1	Introduction to Sociology

courses in health science

HS 1 - HEALTH AND SOCIETY

2 Units

Prerequisites: None
2 hours lecture weekly.

Consideration of the nature and function of health in our social pattern. An analysis of major health problems designed to contribute to the student's understanding of his role as an individual and as a contributing member of the community's efforts to implement the advances of medicine and the health sciences.

Equivalent to Health 120, CSUN

HS 4 - FAMILY HEALTH AND HOME NURSING

3 Units

Prerequisites: None
3 hours lecture weekly.

This course consists of studying recent national trends in family health, identification and treatment of common diseases in the home; equipment, foods, and first aid methods for treating diseases, drug use, accidents and conditions involving handicapped individuals and pregnancy; and methods of preventative care against diseases in families. (Co-number: HE 26).

Accepted for credit, CSUN

HS 5 - SAFETY AND FIRST AID**2 Units**

Prerequisites: None
2 hours lecture weekly.

The development of positive attitudes toward safety and the application of the concepts of "What constitutes safe living," the prevention of shock, unconsciousness, poisons, fractures, dressings and bandages, care and treatment of athletic injuries. Successful completion of this course qualifies for the standard or the advanced "American Red Cross First Aid to the Injured" certificate. Equivalent to Health 160, CSUN

HS 6 - THE TRAINER & ATHLETIC INJURIES**2 Units**

Prerequisites: None
1 hour lecture, 3 hours laboratory weekly

An introductory course in the basic concepts and skills of the Athletic Trainer. Training room practice, medical aspects of Athletic Training, athletic therapy modalities, strength, conditioning and rehabilitation and diagnostic techniques. Practical experience is provided in taping and for the prevention and care of the athletically injured.
Accepted for credit, CSUN

HS 11 - BACKGROUND FOR ALCOHOLISM--ALIENATION AND ADDICTION**3 Units**

Prerequisites: None
3 hours lecture weekly

A study of alcohol in its relationship to alienation and societal patterns; cultural and family attitudes, causes and addiction, sub-cultures, ethical implications, solutions.

HS 12 - ALCOHOL PROGRAMS INTEGRATION**3 Units**

Prerequisites: None
3 hours lecture weekly

An experimental course combining interactive contact with community agencies, the courts, hospitals, rehabilitation centers and other helping programs. Visits to facilities. Individual field experience by arrangement with instructor.

HS 13 - ALCOHOL PROBLEMS AND PROGRAMS**3 Units**

Prerequisites: HS 11 or 12 suggested
3 hours lecture weekly

An intensified study of the problems facing those whose career fields encompass this area of societal disorientation. Relevant to law enforcement, mental and public health, probation, welfare, nursing, education, the judicial system and related professions. An experiential course involving field experience with cooperating public and private organizations.

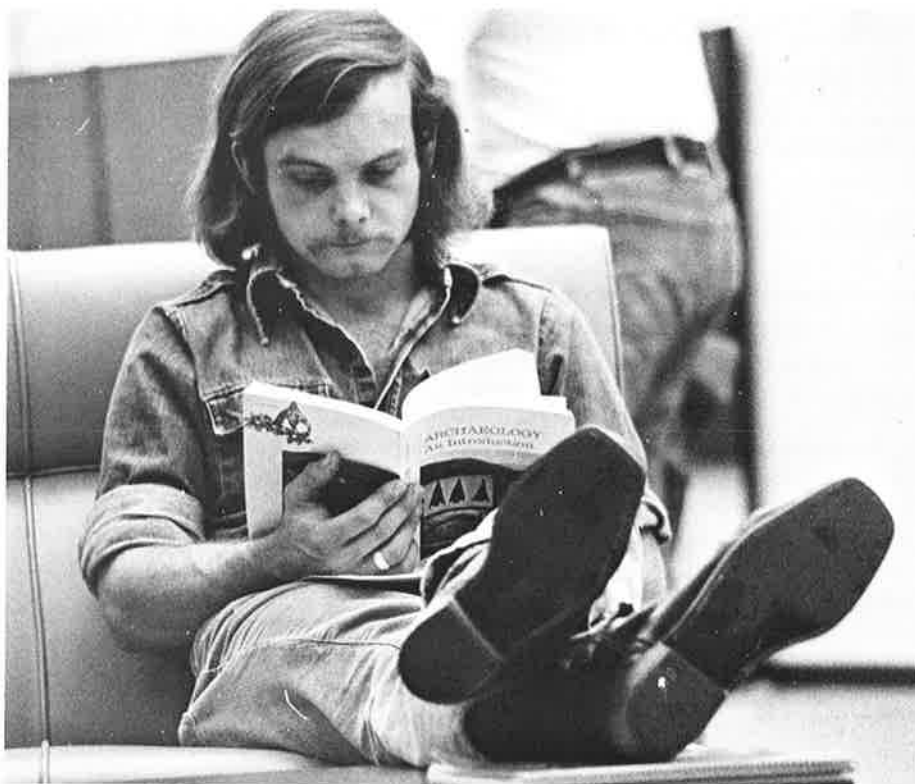

history

Faculty: Arthur Bettini, Cecile Copsey, Joseph Gonzalez,
Randolph Griffith

Historians study the records of the past and write books and articles describing and analyzing past events, institutions, ideas and people. They may use their knowledge of the past to explain current events or to forecast. Approximately 80% of the historians today are employed in schools and colleges. Another 10% are employed in federal government agencies, non-profit foundations, research councils, libraries, and corporations.

REQUIRED COURSES IN THE MAJOR

California State University, Northridge

Hist 1A/1B Intro to West. Civ.
Hist 7A/7B Soc/Pol Hist. of U.S.
For Lan Foreign Language
(3 years of the same
language in high
school or completion
of second semester
of language at college
or a proficiency
examination.)

and one of the following:

Hist 9
Hist 10B
Hist 15B

University of California, Los Angeles

Hist 1A/1B Intro to West. Civ.
For Lan Foreign Language
(3 semesters or 5 quarters)
Engl 1
Phil 1A/1B Intro to Philosophy
or
Engl 2 courses in literature

Plus any three of the following:

Hist 9A/9B
Hist 7A/7B
Hist 15A/15B

courses in history

Hist 1A - AN INTRODUCTION TO WESTERN CIVILIZATION **3 Units**

Prerequisites: Satisfactory score on Placement Test
3 hours lecture weekly

A survey of important events and developments in western civilization from prehistory through the sixteenth century; readings and discussions on important ideas, institutions, and contributions. (F)

This course may be counted for Social Science or Humanities State College General Education requirements.
Equivalent to History 150, CSUN
Accepted for credit UC (all branches)

Hist 1B - AN INTRODUCTION TO WESTERN CIVILIZATION **3 Units**

Prerequisite: Satisfactory score on Placement Test.
3 hours lecture weekly

A survey of important events and developments in western civilization from the seventeenth century to modern times; continued readings and discussions on important ideas and institutions. (F)

This course may be counted for Social Science or Humanities State College General Education elective credit.
Equivalent to History 151, CSUN
Accepted for credit UC (all branches)

Hist 3 - AFRO-AMERICAN HISTORY **3 Units**

Prerequisites: None
3 hours lecture weekly.

Analysis of the history of the Negro in the United States, with special emphasis on contemporary implications on historical events. This course points out the major roles played and contributions made both collectively as a people and as specific individuals in the development of the United States of America.

Accepted for credit, CSUN
Accepted for credit, UC (all branches)

**Hist 4 - HISTORY OF THE MEXICAN PEOPLE IN
THE SOUTHWEST** **3 Units**

Prerequisites: Satisfactory score on Placement Test or
consent of instructor
3 hours lecture weekly.

A survey of the history of the Mejjicano from the pre-Columbian period to the present. Emphasis will be on the Mexican settlement of the region and the contributions of the Mejjicano to the development of the five Southwestern states (Arizona, California, Colorado, New Mexico and Texas). This course satisfies Degree requirements in American Institutions. (F,S,) (Co-numbered MAS 4)
Accepted for credit, UC (all branches)

Hist 5 - UNITED STATES HISTORY**3 Units**

Prerequisites: Satisfactory score on Placement Test
3 hours lecture weekly.

A thematic and problems approach to a survey of American history. Consideration is focused on the historical development of institutions and values that shape present-day America. Topics include: democratic government; the use of nature; work; political and social reform; experiences of discrimination based on sex, race, and nationality; contributions of individuals and groups. This course satisfies Degree requirements in American Institutions.

Hist 6 - HISTORY OF THE AMERICAN INDIAN**3 Units**

Prerequisites: Satisfactory score on Placement Test or consent
of instructor
3 hours lecture weekly

A survey of the history of the indigenous peoples of the Western Hemisphere from pre-Columbian times to the present. Emphasis will be placed on the peoples and cultures of North America, especially as those peoples have inter-mixed and associated with Anglo-Americans.
Accepted for credit, CSUN

Hist 7A - SOCIAL AND POLITICAL HISTORY OF THE UNITED STATES**3 Units**

Prerequisite: Satisfactory score on Placement Test
3 hours lecture weekly.

Survey of the creation and development of American Society to 1865. Analysis of the impact of both individuals and groups, evaluation of issues of religion, race, reform, revolution, responsive government, sectionalism, and expansion. This course satisfies Degree requirements in American Institutions. (F,S)
Equivalent to History 270, CSUN
Accepted for credit, UC (all branches)

Hist 7B - SOCIAL AND POLITICAL HISTORY OF THE UNITED STATES**3 Units**

Prerequisite: Satisfactory score on Placement Test.
3 hours lecture weekly.

An evaluation of social and political adjustment from 1865 to the present. Significant historical events and issues that affect contemporary Americans are surveyed and analyzed by examining significant individuals and groups. Such issues and events as westward expansion, industrial development, ethnic confrontations and contributions, religious toleration, social and political reform movements, and international involvements are explored.

The year sequence of History 7A/7B is required for History majors and recommended for other students who want a thorough survey of the political and social development of the United States: either semester may be taken independently. This course satisfies Degree requirements in American Institutions. Equivalent to History 271, CSUN
Accepted for credit, UC (all branches)

Hist 8 - HISTORY OF CALIFORNIA**3 Units**

Prerequisites: Satisfactory score on Placement Test
3 hours lecture weekly.

A survey of the Indian, Spanish, Mexican, and American periods of California with consideration of political and cultural developments.
Accepted for credit, CSUN
Accepted for credit, UC (all branches)

***Hist 9A - HISTORY OF THE AMERICAS** **3 Units**
Prerequisites: Satisfactory score on Placement Test or consent of instructor
3 hours lecture weekly.

A study of Spanish, Portuguese, French and English conquest, exploration and colonization of the new world, and the main developments in Colonial life in each area up to independence. (F)
Accepted for credit, UC (all branches)

***Hist 9B - HISTORY OF THE AMERICAS** **3 Units**
Prerequisites: Satisfactory score on Placement Test or consent of instructor
3 hours lecture weekly.

A study of the comparative development of the American nations since independence, considering their constitutions, leadership, religions, relations with each other, and their adjustment to the principle of democracy. (S)
Accepted for credit, UC (all branches)

*Hist 9A and Hist 9B combined
are equivalent to History 161, CSUN

Hist 10A/B - AFRICAN HISTORY **3-3 Units**
Prerequisite: Satisfactory score on Placement Test or
consent of instructor.
3 hours lecture weekly.

A survey of African history with attention given to social and economic as well as political aspects of the development of indigenous cultures and the colonial experience.
Accepted for credit, UC (all branches)
Accepted for credit, CSUN

Hist 15A/B - INTRODUCTION TO THE HISTORY OF ASIA **3-3 Units**
Prerequisite: Satisfactory score on Placement Test.
3 hours lecture weekly.

Survey of the countries and cultures of Asia and their contact with the Occident; first semester emphasis on the nineteenth century, and second semester emphasis on the twentieth century.
Accepted for credit, UC (all branches)
Accepted for credit, CSUN

Hist 22A/B - DIRECTED STUDIES IN HISTORY **1-3 Units**
Prerequisite: A course in the specific field with a recommending grade and
consent of instructor and Division Chairman.
1-3 hours tutorial weekly.

Designed for selected students who are interested in furthering their knowledge of history on an independent study basis. Assigned problems will involve library and field work.
3 units maximum credit, CSUN
Accepted for credit, UC (all branches)



home economics

Faculty: Judy Crowe, Polly Stringer

Home Economics curriculum patterns are designed to stimulate personal development, creativity and effective home management. In addition to preparation for a career, curricula are planned to develop techniques and skills beneficial in family and social life. Courses deal with physical, psychological, aesthetic, and economic aspects significant to our changing society.

REQUIRED COURSES IN THE MAJOR

California State University, Northridge		University of California, Santa Barbara	
HE 31	Textiles	HE 31	Textiles
HE 30	Apparel Selection and Grooming	HE 10	Nutrition
HE 10	Nutrition	ECD 30A	Child Growth and Development
Chem 12	Elementary Chemistry I	Chem 1A	General Chemistry
Chem 13	Elementary Chemistry II	Chem 1B	General Chemistry (Foods and Nutrition Option)
Biol 2A	General Biology	Chem 7	Organic Chemistry
Art 4A	Color and Design	Biol 2A	General Biology
Journ 2	News Reporting and Writing (Industrial Option)	Psych 2	General Psychology
Bus 1A	Accounting Principles	Econ 1A	Principles of Economics
Econ 1A/B	Principles of Economics	Soc 1	Intro to Sociology
Soc 1	Intro to Sociology (Dietetics Option)	Speech 1	Intro to Speech
		Art 2	Art Appreciation
		Anth 2	Cultural Anthropology (Textiles Option)

HOME ECONOMICS - AIRLINE HOSTESS

Applicants for airline stewardess training must generally meet the following basic qualifications:

Age: 20 through 27	Marital Status: Single
Height: 5'2" to 5'9"	Vision: 20/50 or better without glasses.
Weight: 100 to 140 pounds	Contacts considered.

Each applicant is required by the airlines to pass a rigid physical examination approved by the medical department of the airlines.

REQUIRED COURSES IN THE MAJOR

HE 10	Nutrition
HE 30	Apparel Selection and Grooming
HE 11	Food Preparation
ECD 30A	Child Growth & Development
Speech 15	Practical Speech
HS 5	Safety & First Aid
Geog 11	Travel Geography

HOME ECONOMICS - COSTUME DESIGN

Home Economics is the field of knowledge and service primarily concerned with strengthening family life through the attainment of well-being of individuals and families, the improvement of homes and the preservation value significant to home life.

PREPARATION FOR THE MAJOR

HE 31	Textiles	HE 36	Advanced Pattern Design
HE 32	Clothing Construction	HE 37A	Tailoring
HE 35	Pattern Design	Art 12A/B	Drawing & Composition
HE 30	Apparel Selection & Grooming	Art 4A	Color and Design

courses in home economics

HE 3 - HOME MANAGEMENT

2 Units

Prerequisites: None
2 hours lecture weekly

A study of management and efficient use of time, energy, and materials within the home. Designed to enable the student to plan utilization of resources in terms of goals of families and their individual members. (F)

HE 4 - HOUSEHOLD EQUIPMENT MANAGEMENT LABORATORY

1 Unit

Prerequisites: None
3 hours laboratory weekly

Selection, use, care and maintenance of materials, surfaces, and mechanical equipment used in the home. Emphasis on selection and experimental testing of equipment and materials.
Accepted for credit, CSUN

HE 5 - INTERIOR DECORATING

3 Units

Prerequisites: None. Art 4A is recommended.
3 hours lecture weekly

Principles and elements of design and color as applied to home interiors. Materials, organization, and arrangement as related to living needs. Offers basic preparation for students who plan to seek employment in the field of interior design. Field trips will be required. (S)
Accepted for credit, CSUN
Accepted for credit, UC (all branches)

HE 10 - NUTRITION

3 Units

Prerequisites: None
3 hours lecture weekly

A study of foods in relation to body needs with emphasis on better health through improved eating habits. Designed to enable students to plan diets for family members of all ages. (F,S)
Equivalent to HE 207, CSUN
Accepted for credit, UC (all branches)

HE 11 - FOOD PREPARATION

3 Units

Prerequisites: None, Lab fee required.
2 hours lecture, 3 hours laboratory weekly.

Selection and preparation of standard food products. Use of imagination is stressed. Students will gain experience in different kitchen environments such as: gourmet, bachelor, young homemakers, apartment and family.
Equivalent to HE 208, CSUN

HE 14 - BACHELOR FOODS

3 Units

Prerequisites: None, Lab fee required.
2 hours lecture, 3 hours laboratory weekly.

Mainly pursuits into the field of food preparation. Creativity, space-age cooking, use of "special" ingredients, and barbecue cooking stressed. Practical meal preparation as well as gourmet cooking. Available to male students only.

HE 15 - COOKING CREATIVELY

3 Units

Prerequisites: Food preparation course in high school or college recommended, Lab fee required.
2 hours lecture, 3 hours laboratory weekly.

Use of imagination in preparation of foods and in meal planning. Use of special ingredients stressed, such as cooking with wine, herbs and spices. Experience in dinner preparation from hors d'oeuvre through desserts.

HE 16 - FOREIGN FOOD COOKERY

3 Units

Prerequisites: Food preparation course in high school or college recommended, Lab fee required.
2 hours lecture, 3 hours laboratory weekly.

Techniques and concepts involved in preparation of foods characteristic of foreign countries. Students will gain experience in preparation of foods characteristic of Mexico, Italy, France, Spain, Germany, China, and Japan.

HE 22A/B - DIRECTED STUDIES IN HOME ECONOMICS

1-3/1-3 Units

Prerequisites: A course in the specific field and the consent of the instructor and Division Chairman.
1-3 hours tutorial weekly.

Designed for selected students who are interested in furthering their knowledge of home economics on an independent study basis. Assigned problems will involve library, laboratory, and field work. Maximum of 6 units.
3 units maximum, CSUN

HE 26 - FAMILY HEALTH AND HOME NURSING

3 Units

Prerequisites: None
3 hours lecture weekly.

This course consists of studying recent national trends in family health, identification and treatment of common diseases in the home; equipment, foods and first aid methods for treating diseases, drug use, accidents and conditions involving handicapped individuals and pregnancy; and methods of preventive care against diseases in families. (Co-number: HS 4)

HE 30 - APPAREL SELECTION AND GROOMING

3 Units

Prerequisites: None
2 hours lecture, 3 hours laboratory weekly

Applications of the principles of design and color harmonies in selection of clothing. Wardrobe and personal grooming and analysis is coordinated pertaining to individual skeletal structure, personality and individual requirements. Exercise and physical movement analysis are integrated into the course with students receiving physical education credit.

Equivalent to HE 170, CSUN
Accepted for credit, UC (all branches)

[REDACTED]

HE 31 - TEXTILES

2 Units

Prerequisites: None
2 hours lecture weekly.

A study of textile fibers, their construction, characteristics, finishes, uses and care. Designed to give a basic knowledge of textiles which will help the student in selecting and caring for textiles. (F,S)
Equivalent to HE 161, CSUN
Accepted for credit, UC (all branches)

HE 32 - CLOTHING CONSTRUCTION

3 Units

Prerequisites: None
2 hours lecture, 3 hours laboratory weekly.

Psychological, sociological aspects of clothing, clothing construction with emphasis on the commercial pattern, relationship of fabric to design, care of clothing, construction techniques and basic fitting. (F)
Equivalent to HE 162, CSUN
Accepted for credit, UC (all branches)

[REDACTED]

HE 35 - FLAT PATTERN DESIGN

3 Units

Prerequisites: HE 32 or consent of instructor, HE 31
(May be taken concurrently)
2 hours lecture, 3 hours laboratory weekly.

Principles and techniques of constructing the basic pattern, original design and construction of a garment using flat pattern methods. Designed to enable the student to create original patterns and garments of appropriate fabrics.
Accepted for credit, UC (all branches)

[REDACTED]

HE 36 - ADVANCED PATTERN DESIGN

3 Units

Prerequisites: HE 35 or consent of instructor
2 hours lecture, 3 hours laboratory weekly.

Designing patterns of any style quickly and accurately. Stress on development of creative ability and quality craftsmanship.
Accepted for credit, UC (all branches)

HE 37A - TAILORING

3 Units

Prerequisite: HE 32 or consent of instructor
2 hours lecture, 3 hours laboratory weekly.

Selection and construction of garments requiring tailoring techniques. Designed to enable the student to select and construct tailored garments of high quality.

[REDACTED]

HE 37B - TAILORING

3 Units

Prerequisites: HE 37A
2 hours lecture, 3 hours laboratory weekly

Advanced Tailoring techniques applied to design and construction of suits and coats. Presentation of couture techniques including fitting, styling and selection of fabric for the custom touch.

[REDACTED]

HE 39 - CREATIVE STITCHERY

2 Units

Prerequisites: None

1 hour lecture, 3 hours laboratory weekly

The course would stimulate the creativity of women to design and make handcrafted items for their homes and family and teach the skills required for making and designing these items. Included will be projects in burlap stitchery, needlepoint, patchwork, quilting, dollmaking, dollclothes tips, crewel stitchery, macrame, crocheting, and decopage.

HE 51A/B/C - INSTITUTE IN CONSUMER EDUCATION

1-1-1 Units

Prerequisites: None

16 hours lecture each unit

Three short-term lecture series in Consumer education with stresses on (51A) Clothing and Textiles, (51B) Foods, and (51C) Household goods. Designed for homemakers on restricted incomes.

For information regarding Work Experience credit in the Home Economics program, refer to Page 224 in this catalog.

hotel & restaurant management

The hotels, motor inns, motels, resorts, restaurants, cafeterias, hospitals and institutional food establishments offer career opportunities leading to responsible and attractive position in the management of these industries. The increase in leisure time and the growth of tourism all indicate a growing demand in the service industry for trained personnel.

REQUIRED COURSES IN THE MAJOR

H&R 1*	Hotel & Restaurant Orientation
H&R 2A+	Basic Food Preparation I
H&R 2B+	Basic Food Preparation II
H&R 3	Supervision of Food Production
H&R 10*	Restaurant Operations
H&R 12*	Food Purchasing
H&R 20*	Menu Planning
H&R 23*	Sanitation and Environmental Control
H&R 24*	Food and Cost Control
	Directed Work Experience
HE 10	Nutrition
Bus 7	Calculating Machines

*A student currently employed in the field may receive an In-Service Certificate in HOTEL & RESTAURANT MANAGEMENT upon successful completion of the courses marked * and 6 additional units in General Education, for a total of 21 units.

+A student not currently employed in the field may receive a Pre-Service Certificate in HOTEL & RESTAURANT MANAGEMENT upon successful completion of the courses marked + plus the courses marked + and 9 additional units in General Education, including 6 units of Hum 1A or Hum 1B, for a total of 30 units.

courses in hotel & restaurant



H&R 1 - HOTEL & RESTAURANT ORIENTATION

1 Unit

Prerequisites: None
1 hour lecture weekly

A lecture course on the organization and job potential of various types of food service establishments. An understanding of the education and experience required of the job positions available from top management down to kitchen helpers.

H&R 2A/B - BASIC FOOD PREPARATION I AND II

2-2 Units

Prerequisites: None
1 hour lecture, 3 hours laboratory

The study and laboratory experience of a quantity food operation. The introduction and application of the principles of good cookery to quantity food production. Emphasizing high production standards, attractive service, use of proper equipment and proper utilization of time. Use of left-overs, methods of food preservation and recipe standardization will be covered.

Baccalaureate Level

H&R 3 - SUPERVISION OF FOOD PRODUCTION

2 Units

Prerequisites: H&R 2A/B
1 hour lecture, 3 hours laboratory

The lecture, laboratory experience in the fundamentals of food production and cookery, emphasizing high standards of production. Includes the preparation of small quantities of the various food groups, and the understanding of the principles underlying their preparation, principles of work-simplification.

H&R 10 - RESTAURANT OPERATIONS

3 Units

Prerequisites: H&R 2A/B
3 hours lecture weekly

Principles and practice of operating a restaurant. Covers such areas as location, organization, capital, equipment standards and labor. Experience is given in operating different areas in the cafeteria.

H&R 12 - FOOD AND BEVERAGE MANAGEMENT AND SERVICES **3 Units**

Prerequisites: H&R 2A
3 hours lecture weekly

The material in the course is designed to familiarize the student with principles and procedures that have been proven in actual operations. Sufficient background information will be provided to help the student obtain a good grasp of these so that he may apply them most readily to present and future situations.

H&R 11 - FOOD PURCHASING

3 Units

Prerequisites: H&R 2A
3 hours lecture weekly

This course provides training in the duties, organization, and policies of the purchasing function in a hotel and restaurant establishment. Instruction is given in the proper techniques for purchasing of foods, food standards and appropriate legislation, comparative and competitive buying of meats, staples, vegetables and canned and frozen foods.
Baccalaureate Level

H&R 20 - MENU PLANNING

1 Unit

Prerequisite: None
1 hour lecture weekly

Examines the basic principles of menu making. Consideration is given to all phases of menu planning, merchandising and control. Factors affecting the planning of a menu will be discussed, including types of operation, seasons of the year, clientele, equipment, and personnel available. (F)

H&R 21 - BEGINNING BAKING

1 Unit

Prerequisites: None
3 hours laboratory weekly

This course provides instruction to students in the methods and procedures involved in preparing, baking, and decorating a variety of bakery products including breads, cakes and pastry.

H&R 22A/B - DIRECTED STUDIES IN HOTEL AND RESTAURANT MANAGEMENT

1-3/1-3 Units

Prerequisites: H&R 2A/B
1-3 hours tutorial weekly

Designed for selected students who are interested in furthering their knowledge of Hotel and Restaurant Management on an independent study basis. Assigned problems will involve library, laboratory, and field work. Maximum of 6 units.

H&R 23 - SANITATION AND ENVIRONMENTAL CONTROL

2 Units

Prerequisites: None
3 hours lecture weekly

A lecture-laboratory demonstration course to acquaint the student with the basic principles of microbiology and how to apply this knowledge to the need for personal cleanliness; cause, control and investigation of illnesses caused by food contamination; sanitary practices in food preparation; proper dishwashing procedures; sanitation of kitchen, dining room and all equipment; cleaning materials and procedures; garbage and refuse disposal.

H&R 24 - FOOD AND COST CONTROL

2 Units

Prerequisites: H&R 2A/B
2 hours lecture weekly

A study of food control and its importance, covering essential records and information for cost control, the importance of ordering, receipt of goods, inventories, storerooms, issues, standardized recipes and proper food preparation in the control of costs. Number and utilization of kitchen employees to labor costs. Percentage distribution of costs.
Baccalaureate Level

H&R 25 - STORAGE, SAFETY AND EQUIPMENT

2 Units

Prerequisites: None
3 hours lecture weekly

This course will acquaint the student in a lecture demonstration situation with the proper methods for receiving and storage of food and equipment in a food service; proper safety precautions, elementary first aid; the use and care of both small and large equipment, and elements of kitchen planning.

H&R 29 - INSTITUTIONAL FOOD SERVICE

3 Units

Prerequisite: None
1 hour lecture, 6 hours laboratory weekly

Principles of operating an Institutional Food Service, a lecture-laboratory situation teaching organization, administration, policies, financing and controls. (S)

For information regarding Work Experience credit in the Hotel and Restaurant Management program, refer to Page 224 in this catalog.

humanities

The majority of the courses listed under the Humanities heading are interdisciplinary and team-taught, affording the student an opportunity to study more than one traditional discipline at the same time and in a manner which inter-relates these disciplines. In those courses taught by several teachers the students are presented with ideas from different points of view by individuals who have studied and have been trained in the particular disciplines included in the course.

The interdisciplinary courses are designed to provide the student with transfer credit meeting General Education Requirements in more than one area of study.

Included in this section is a summary of the integrated and team-taught courses, tabulated to provide a convenient overview of the course equivalencies and the principal emphases given in the course.

SUMMARY OF TEAM-TAUGHT AND/OR INTEGRATED COURSES FROM HUMANITIES/SOCIAL SCIENCES

PROGRAM	COURSE EQUIVALENCIES	STAFF	COMMENT
Humanities 1A/1B	Fulfills AA Degree Requirements in American Institutions, Fine Arts, and English. Transfer credit as elective in CSU General Education if student successfully completes, in addition, English 1 and a basic course in Social Science.	Davie Hannon Klose Seely	The class meets for two large group 1½ hour presentations followed by small discussion sections.
Humanities 5A/5B	Transfer Credit - First Semester: Psych 2, Engl 1, Engl 19 Second Semester: Psych 3, Engl 1, Social Science	Pacheco Popiel	Class sessions employ discussion, lectures, films, non-verbal exercises and field trips.
Humanities 6	Transfer credit - Engl 1 and Art 2	Gray Sheridan	Exploration of various modes of expression; photography, film structural construction, concrete poems, "readymades," aeriographs, monoprints collages.
Humanities 8	Transfer credit - Engl 1 and Music 8	Edwards	Understanding ways in which writers and musicians use sounds to establish meaning and importance (classical poets, composers, jazz, rock and pop.)
Humanities 15	Transfer credit - Music 8 and English 1	Ingersoll Ekback Hanft Mallory Sheridan	Primary focus will be on music and literature, with limited exploration of theatre and art. Special consideration will be given to genre of film.
Humanities 16 (evening course)	Transfer credit - Music 8X (2 units) Engl 1 (1½ units)	Ingersoll Ekback Mallory Sheridan	Primary emphasis will be placed on literature, music, and art with secondary emphasis on drama and dance
Sociology/English	Transfer credit - Engl 1 (3 units) Soc 1 (3 units)	Adler Lossner	This interdisciplinary program considers literature as an expression of social-psychological processes in addition to the literary strategies which the writer employs.
Engl/Anthropology (Man in Nature)	Transfer credit - Engl 1 (3 units) Anthro 2 (3 units)	Black Davie Rolff	To direct the students toward an understanding of his own nature, and of his relationship with the natural world. Study of alternative cultures which reflect different attitudes.

courses in humanities

Hum 1A/B - MAN IN SOCIETY

6-6 Units

Staff: Taylor Klose, Mike Seely, John Davie, James Hannon

Prerequisite: None

5 hours lecture, 3 hours laboratory weekly.

A general education course designed to increase the student's understanding of the key issues in the social sciences, literature, and the arts. This course will develop the student's awareness of his heritage and of his world, master his freedom and responsibility in a democratic society, and improve his skills in oral and written communication.

The class meets for two large group hour-and-a-half presentations consisting of a series of lectures, illustrated talks, films, slide presentations and panel discussions. Each large group presentation is followed by a small discussion section. In conjunction with the discussion section, the student completes 51 hours of laboratory work per semester. This is made up by attendance at plays, lectures, films, political and social events. A field trip is required. Tutorials are scheduled with the faculty members and listening experiences will be scheduled in the Audio-Visual section.

Humanities 1A-B fulfills the A.A. degree graduation requirements in American Institutions, Fine Arts, and English Composition. Acceptable as General Education elective if student successfully completes, in addition, English 1 and a basic course in Social Sciences.

Hum 5A/B - AWARENESS, CHOICE AND FREEDOM

9-9 Units

Staff: Jon Popiel, Darlene Pacheco

Prerequisites: Satisfactory score on Placement Test

9 hours lecture weekly

Examines Psychology and English as disciplines, and, most important, as illuminations of human phenomena. Builds on the premise that awareness leads to recognition of choices, and that when choice is recognized and acted upon, authentic freedom results. Assumes that existence is organic. As all knowledge is ultimately related, so is all life. Qualities attributed to humans are shared, to a greater or lesser degree, by other creatures. It is the emphasis on certain of these qualities, and their novel combination, that define "human". Considers human dynamics, including perception, emotion, motivation, communication, self-concept, valuing, and relating.

Employs reading, observation, film, discussion, lecture. Exercises in analysis, development of ideas, recognizing levels of abstraction, integrating concepts and experience.

COURSE EQUIVALENTS:

Fall Semester - Psych 2 (3 units), Engl 1 (3 units), Engl 19 (3 units)

Spring Semester - Psych 3 (3 units), Engl 1 (3 units), Soc Sci (3 units)

Accepted for credit, CSUN

Accepted for credit, UC (all branches)

Hum 6 - ART AND THE WRITTEN WORD**6 Units**

Staff: Pam Sheridan, John Gray
Prerequisites: Eligibility for English 1
6 hours lecture weekly

The course will focus upon the relationship between language and the audio-visual arts. Students will examine selected works in various media, such as language, graphics, and film, with a view toward exploring the nature of art. A primary goal of the course will be to introduce students to the basic vocabulary and tools of the fine arts including language and to encourage him to use these tools for interpretation and expression. Not suggested for Art majors. Students will receive 3 units of credit in English 1 and 3 units of credit in Art 2.

Accepted for credit, CSUN
Accepted for credit, UC (all branches)

Hum 7 - ARTS AND MAN**5 Units**

Staff: Linda Moore
Prerequisites: Eligibility for English 1

Relating a variety of themes concerning the performing arts with an emphasis on the musical. Content will include form, style, rhythm and other perceptions of these arts. Students will examine these activities as both a participant and spectator. Compositional experiences will also be included. Course equivalent for 1½ units of English 1; 3 units of Music 8; ½ unit P.E.

Accepted for credit, CSUN

Hum 8 - LITERATURE AND MUSIC**6 Units**

Staff: Richard Edwards

Prerequisites: Eligibility for English 1
6 hours lecture weekly

Exploration of relationships between literature and music. This course will emphasize in particular the uses which writers have made of music, and the uses which composers have made of literature. The works of such men as Shakespeare, Beethoven, Dylan, Wordsworth, Mozart Purcell, Handel and the writers of the Holy Bible, will be studied, as well as important aesthetic movements such as classicism and romanticism. Students will be expected to write regularly; extensive use of recorded musical performance will be made. (Students will receive 3 units of credit in English 1 and 3 units of credit in Mus 8.)

Accepted for credit, CSUN
Accepted for credit, UC (all branches)

Hum 11 - MEDITATION**1 Unit**

Staff: Barbara Selak
Prerequisites: None
2 hours lecture weekly

Analysis and practice in meditative procedures and techniques. A practical approach to increasing awareness through traditional exercises and methods of concentration.

Hum 12 - THE PRACTICE OF TAI CHI CHUAN

1 Unit

Prerequisites: None
3 hours activity weekly

Tai Chi Chuan is an ancient Chinese system of isometric dance forms consisting of 108 movements carried out in a slow, continuous, rhythmic sequence, inducing health, relaxation and peace of mind. The actual movements of Tai Chi Chuan will be learned and practiced.

Hum 15 - COMMUNICATIONS

6 Units

Prerequisites: Eligibility for English 1
6 hours lecture weekly

Exploration of various modes and styles of communication. The primary focus will be on literature and oral communication, emphasizing self-expression through music with limited exploration of theatre, dance and film. Students will receive 3 units of credit in English 1 and 3 units of credit in Music 8.

Accepted for credit, CSUN
Accepted for credit, UC (all branches)

Hum 16 - EXPRESSION IN THE ARTS

3½ Units

Prerequisites: Eligibility for English 1
3½ hours lecture weekly

The student will encounter, through presentation and discussion, the media of artistic communication current in today's society. Primary emphasis will be on music and literature, with secondary exploration of cinema, theatre and art. Student will receive 1½ units credit in English 1; 2 units credit in Music 8.

Hum 22A/B - DIRECTED STUDIES IN HUMANITIES

1-3 Units

Prerequisites: A course in the specific field with a recommending grade and consent of the instructor and Division Chairman
1-3 hours tutorial weekly

Designed for selected students who are interested in furthering the knowledge of Humanities on an independent study basis. Assigned problems will involve library, laboratory, and field work. Maximum of 6 units.



industrial technology

Refrigeration technology is just one of the many fields in Industrial Technology. Future plans call for expansion to a full program of pre-service and in-service training in Heating & Air Conditioning

IT 2 - INTRODUCTION TO REFRIGERATION

4 Units

Prerequisites: Acceptance into Heating & Air Conditioning Program

2 hours lecture, 6 hours laboratory weekly

Principles of refrigeration, physical laws involved in refrigeration, heat transfer, fluid flow, refrigeration cycles, refrigerants, lubrication systems and refrigeration circuit problems.

IT 3 - COMMERCIAL REFRIGERATION

6 Units

Prerequisites: IT 2 and student in good standing in Heating, Air Conditioning and Refrigeration Program

3 hours lecture, 9 hours laboratory weekly

The commercial use of refrigeration. Refrigerated storage, some storage conditions, refrigeration equipment, defrosting methods, refrigerants, regulators, accessories, insulation, installation, start-up and service.

instructional aide programs

Instructional Aide - Communication Skills

Instructional Aide - Mathematics

Instructional Aide - General

The three Instructional Aide programs are designed to provide one-year certificates of completion (pre-service or in-service) for students desiring to work as instructor aides in grades K through 14. The programs train the students for entry into jobs that now exist in many of the elementary schools and in some of the secondary schools in the local area. These positions are for work as general aides, for work in specific disciplines (Communication Skills and Math), for work with educationally and emotionally handicapped students, and for work with bi-lingual, bi-cultural students.

To receive a certificate in any one of the three Instructor Aide areas the student must complete the required course work with a letter grade of C or better in each course. In the Communication Skills program he must also pass a proficiency test. The head of the Mathematics Department or the head of the English Department should be consulted for required and recommended courses for specialization in Mathematics and Communication Skills respectively. Much of the course work required is baccalaureate level and will transfer to a four-year school.

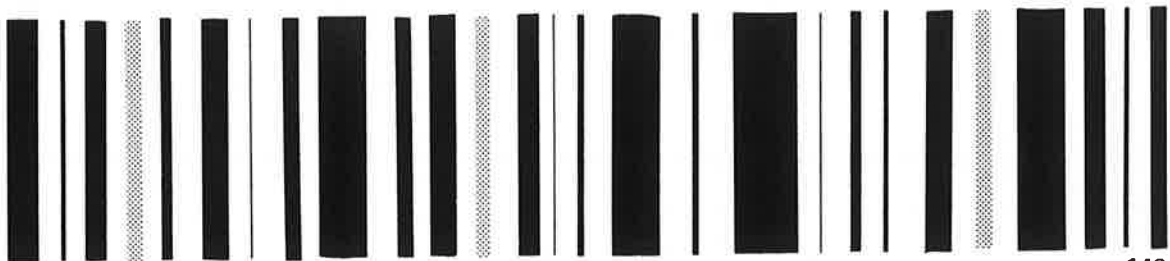



journalism

Faculty: Marge Imbach, Alfred Miller

Journalism embraces the writing, editing, managing, and production of mass-media communication. Journalists are involved, therefore, not only in the preparation of all types of periodicals, but also in the fields of advertising, public relations, radio, television, and motion pictures. There are wide opportunities for journalists not only in newspaper and magazine writing, but also in trade, business, and labor publications, and in such specialized fields as editorial work, writing of feature articles, fiction, poetry, and drama.

REQUIRED COURSES IN THE MAJOR

California State University, Northridge

Journ 1 Intro to Mass Communications

Journ 2 New Reporting

Minor in a related field such as

English, History, Political

Science, or Sociology

150

University of Southern California

Journ 1 Intro to Mass Communications

Journ 2 News Reporting

courses in journalism

Journ 1 - MASS COMMUNICATIONS

3 Units

Prerequisites: None

3 hours lecture, 1 hour laboratory weekly.

This course will acquaint the student with the origins, development and contemporary role of newspapers, magazines, cinema, radio, TV, and related fields such as advertising and public relations. Will survey the history and the application of mass communications. The course will also involve related critical and practical applications of this information. (Co-Number Broad 1)
Equivalent to Journ 100, CSUN

Journ 2 - NEWS REPORTING AND WRITING

3 Units

Prerequisite: None.

2 hours lecture, 3 hours laboratory weekly.

An introduction to journalism with an emphasis on developing news writing skills through interviewing, reporting, evaluation of news significance, collection of accurate facts, and writing of news copy. Practical experience is gained through writing for the school newspaper. (F,S)
Equivalent to Journ 110, CSUN

***Journ 3 - FEATURE WRITING**

3 Units

Prerequisite: None

2 hours lecture, 3 hours laboratory weekly.

The writing of feature articles as used in magazine and newspapers including the techniques used in gathering material. Practical experience given through writing for the school newspaper and magazine. (F,S)
Accepted for credit, CSUN

Journ 6A/B - FCC LICENSE REVIEW

3-3 Units

Prerequisites: None

3 hours lecture weekly

This course will review basic electronics especially pertaining to broadcasting to prepare the student for the series of Federal Communications Commission examinations eventually leading to the FCC First Class Radiotelephone Operator's License. (Co-numbered: ET 6A/B, Broad 6A/B) (6A-F, 6B-S)

Journ 7 - LAYOUT & DESIGN TECHNIQUES

3 Units

Prerequisites: None

2 hours lecture, 3 hours laboratory weekly

Fundamentals of layout and design for graphic reproduction including the principles of design, and the techniques of layout and paste-up. Preparation of line and tone copy for offset reproduction. Designing roughs and visuals and preparation of single and multi-color mechanicals for use in commercial and publication printing. Study of the point system, type identification and copy markup systems. (Co-numbered GC 4)
Accepted for credit, CSUN

Journ 8 - BASIC PHOTO-JOURNALISM

3 Units

Prerequisites: Photo 1A, or suitable portfolio and consent of instructor

2 hours lecture, 3 hours laboratory weekly

Aspects of photography as applied to mass communication--broadcast and print journalism. Concentration on the translation of ideas to images for reproduction in magazines, newspapers and book illustrations. Special effects and the utilization of camera and light as creative tools. Basic motion picture techniques. (Co-number Photo 8)

Accepted for credit, CSUN

Journ 10A/B - NEWSPAPER PRODUCTION

3-3 Units

Prerequisites: Journ 1, Journ 2 or consent of instructor

2 hours lecture, 3 hours laboratory weekly

This is a course in the concept, development, layout and composition of newspapers. Particular emphasis is given to the practical aspects of all phases of newspaper production. Instruction is also given in the graphic arts.

Equivalent to Journ 196, CSUN

Journ 11A/B - MAGAZINE EDITING

3-3 Units

Prerequisites: Journ 1, Journ 2 or consent of instructor

2 hours lecture, 3 hours laboratory weekly

This is a course in the analysis, development, composing and layout of magazines or similar publications. Emphasis is given to coordinating feature stories and related articles with attractive pictorial displays. Instruction is also given in the graphic arts as related to the magazine production. (Co-number Engl 47)

Accepted for credit, CSUN

***Journ 22A/B - DIRECTED STUDIES IN JOURNALISM**

1-3/1-3 Units

Prerequisites: A course in the specific field and the consent of the instructor and Division Chairman.

1-3 hours tutorial weekly.

Designed for selected students who are interested in furthering their knowledge of journalism on an independent study basis. Assigned problems will involve library, laboratory, and field work. Maximum of 6 units. (F,S)

*A maximum of 6 units from these courses will be accepted for credit at CSUN

leadership

Ldr 1A - PRINCIPLES OF LEADERSHIP

1 Unit

Prerequisites: None.

1 hour lecture, 1 hour practicum weekly.

The development of effective group leadership through an understanding of the basic tenets of parliamentary procedure. Practical application of parliamentary procedure in the group situation will be emphasized.

Accepted for credit, CSUN

Ldr 1B - PRINCIPLES OF LEADERSHIP

1 Unit

Prerequisites: None.

1 hours lecture, 1 hour practicum weekly.

The identification of effective leadership and its development; leadership as it relates to the rights and responsibilities of the individual; effective leadership through the understanding of group dynamics.

Accepted for credit, CSUN

library technology

Faculty: John Hurley, Michael Slama, Dale Dobson

There are good career opportunities in college, public, school, industry and government libraries for people specially trained in library work. Moorpark College offers programs to prepare for a library career as a Library Technician in the areas of Acquisitions, Cataloging, Loans, Reference, Audio-visual and Automation. For those students who wish to become librarians, Moorpark College offers a liberal arts program, transferable to the state colleges.

REQUIRED COURSES IN THE MAJOR

LT 1*	Introduction to Library Technology
LT 2*	Library Circulation Procedures
LT 3*	Advanced Library Clerical Techniques
LT 4*	Audio-Visual Clerical Techniques
LT 5*	Audio-Visual for the Library
LT 6*	Children's Literature
LT 48*	Library Internship

RECOMMENDED COURSES FOR THE MAJOR

Bus 11A+	Beginning Typewriting
Bus 11B	Intermediate Typewriting
DP 1+	Introduction to Data Processing

*A student currently employed in the field may receive an In-service Certificate in LIBRARY TECHNOLOGY upon successful completion of 15 units in the courses marked * and 6 additional units in General Education, for a total of 21 units.

+A student not currently employed in the field may receive a Pre-service Certificate in LIBRARY TECHNOLOGY upon successful completion of 15 units in the courses marked * plus the courses marked + and 9 additional units in General Education, for a total of 30 units.

courses in library technology



LT 1 - INTRODUCTION TO LIBRARY TECHNOLOGY

3 Units

Prerequisite: None
3 hours lecture weekly

For students desiring to develop skills in the use of libraries. Includes a study of library tools such as indexes, bibliographies, encyclopedias, dictionaries; arrangement and use of card catalogs, book catalogs, history of libraries, books and printing. (F, S)

LT 2 - LIBRARY CIRCULATION PROCEDURES

3 Units

Prerequisite: LT 1 or consent of instructor
2 hours lecture, 3 hours laboratory weekly

A study of all aspects of library circulation work, including loaning of materials, processing of returned materials, shelving, shelf-reading, preparation of books and periodicals for binding, fine collection and record keeping, putting books on reserve, and other loan procedures and services. (S)
Baccalaureate Level

LT 3 - ADVANCED LIBRARY CLERICAL TECHNIQUES

3 Units

Prerequisite: LT 1 and LT 2 or consent of instructor
2 hours lecture, 3 hours laboratory weekly

Study of procedures and techniques in book ordering, book preparation for the shelves, and elementary cataloging and classification. (F)

LT 4 - AUDIO-VISUAL CLERICAL TECHNIQUES

3 Units

Prerequisite: None
2 hours lecture, 3 hours laboratory weekly

Study of the functions of audio-visual equipment and materials and their use; procedures used in purchasing, renting and scheduling of films, slides, transparencies, and other audio-visual items. (S)

LT 5 - AUDIO-VISUAL FOR THE LIBRARY

2 Units

Prerequisites: None
2 hours lecture weekly

Study of the functions of audio-visual equipment and materials and their use; procedures used in the purchasing, rental and scheduling of films, slides, transparencies, tapes, recording and other audio-visual items. Not open to students completing LT 4.

LT 6 - CHILDREN'S LITERATURE

3 Units

Prerequisites: None
3 hours lecture weekly

Study of the books, periodicals, and other library materials suitable for children of the elementary school age. Reference books suitable for the lower grades, picture books, fiction, non-fiction, folk tales, story telling, books made into films and other materials will be examined in depth. (F,S)
Baccalaureate Level

LT 48 - LIBRARY INTERNSHIP

2-3 Units

Prerequisites: LT 1 or equivalent and consent of instructor
1 hour lecture, 3-6 hours laboratory weekly

Supervised work in an approved library. (F,S)

For information regarding Work Experience credit in the Library Technology program, refer to Page 224 in this catalog.

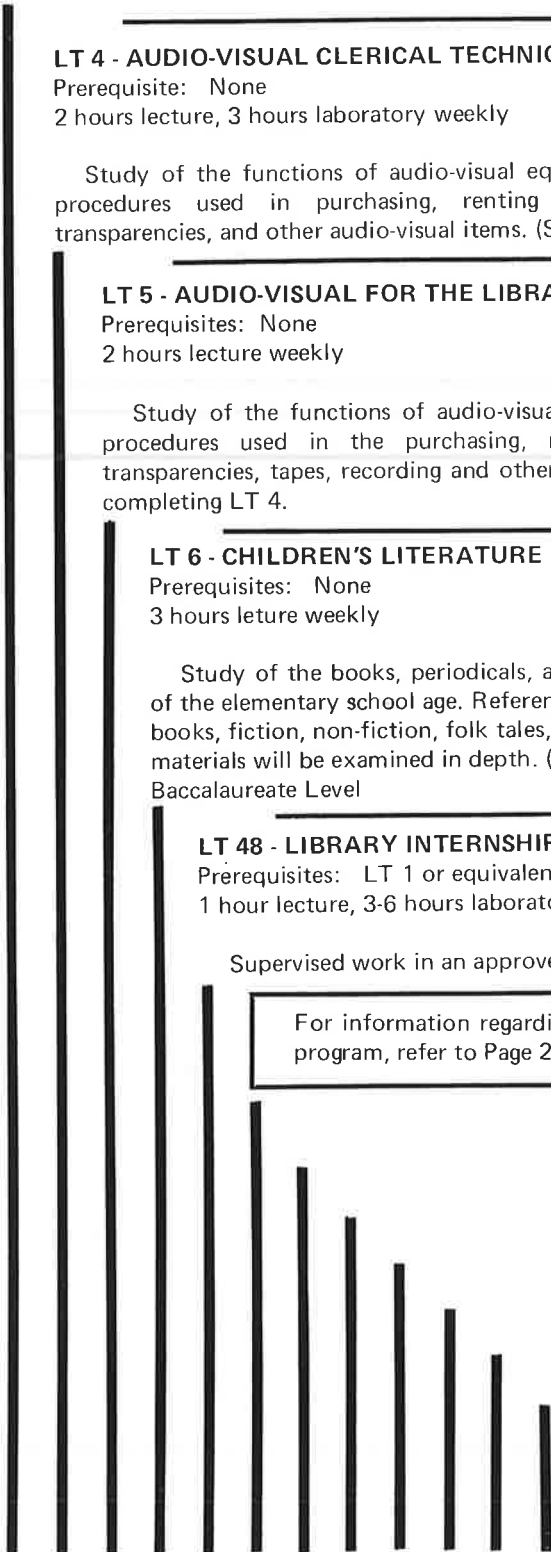

mathematics

Faculty: Alberto Beron, Max Garbutt, James Gayle, Masato Hayashi,
William Jay, Floyd Martin, Charles Molnar, Department Head;
David Riley, Christine Aguilera, Kokki Shindo, Robert Stephens, John Walters.

Plato considered mathematics and music the purest of the sciences, searching out as they do, the abstract structures of the universe. But on a less ethereal plane, applied mathematics develops approaches and techniques to solve practical problems in the physical, biological, and social sciences. Graduates will find careers in business, industry, and government as research mathematicians, as statisticians, as actuaries, as logicians, and as systems analysts. The field of computer science presents a new opportunity for mathematics majors.

REQUIRED COURSES IN THE MAJOR

California State University, Northridge

Math 25A/B/C Calculus/Analytic Geometry
Math 31 Intro to Linear Alg.
Ph 4 Mechanics of Solids and
Fluids
Ph 5 Electricity and Magnetism
Ph 6 Heat, Sound, Optics &
Modern Physics

University of California, Santa Barbara

Math 25A/B/C Calculus/Analytic Geometry
Math 30 Intro to Modern Alg.
Math 31 Intro to Linear Alg.
Ph 4 Mechanics of Solids and
Fluids
Ph 5 Electricity and Magnetism
For Lan Foreign Language

The following information offers guidelines for enrollment in mathematics courses.

The flow chart shown below illustrates the overall mathematics program as well as the various sequences of courses which may be taken by a student depending upon his interests and needs. Initial placement in the mathematics program is dependent upon the student's ability to meet course prerequisites.

In a mathematics course, a grade of C or better or credit indicates that the student is qualified to attempt the next course in his chosen sequence of courses. A grade of D indicates that the student must repeat the course before proceeding in the sequence unless departmental approval is obtained. In addition, if more than two and one-half years have elapsed since the student has completed his highest mathematics course with a grade of C, that course should be repeated before attempting a sequel course.

AN OVERVIEW OF THE MATHEMATICS PROGRAM

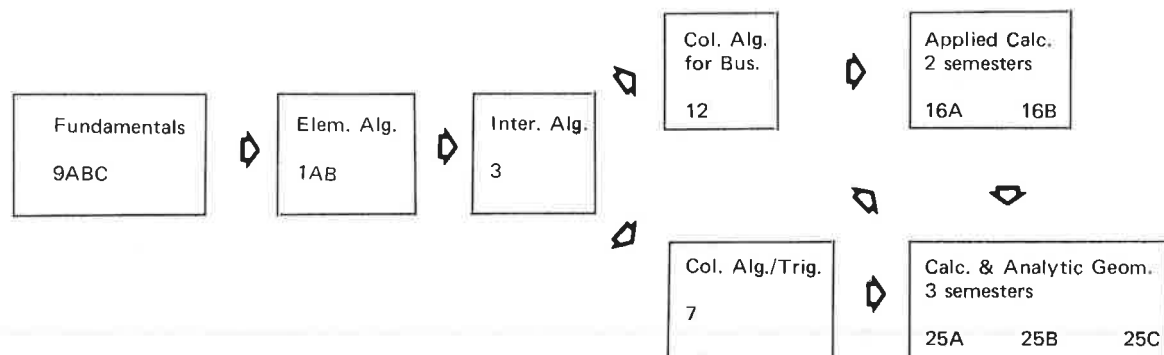

IN ADDITION TO THE ABOVE*

Math 2, 10, and 45 may be taken any time after completion of 1AB.

Math 15 and 18 may be taken any time after completion of 3.

Math 30 may be taken any time after completion of Math 25A.

Math 31 and 35 may be taken any time after completion of 25B.

*For courses not listed see catalog descriptions for prerequisites.

courses in mathematics

Math 1A/B - ELEMENTARY ALGEBRA

2-3 Units

Prerequisites: Math 9C or high school general math
5 hours lecture weekly.

Student will simultaneously enroll in both Math 1A and 1B.

Math 1A - The real numbers, operations with real numbers, linear equations and inequalities, linear systems, integer exponents, and operation with polynomials.

Math 1B - Techniques of factoring, roots and radicals, rational expressions, quadratic equations, quadratic formula.

Math 2 - FUNDAMENTALS OF GEOMETRY

3 Units

Prerequisites: Satisfactory score on Placement Test and Math
1B or one year of high school algebra.
3 hours lecture weekly.

Selected topics including lines, parallel and perpendicular lines, properties of triangles, congruence and similarity of triangles, polygons, circles, coordinate systems, planes, surfaces and areas, spheres, cylinders, volumes, coordinate systems, elementary triangle trigonometry. (F,S)

Math 3 - INTERMEDIATE ALGEBRA

4 Units

Prerequisites: Satisfactory score on Placement Test and Math 1B or
one year of high school algebra (Math 2 may be taken
concurrently)
5 hours lecture weekly

Real numbers, fundamental operations, factoring, fractions, linear equations and inequalities, exponents and radicals, functions and graphs, quadratic equations, and inequalities, conic sections, sequences and series, exponential and logarithmic functions. Equivalent to second year high school algebra. (F,S)
Accepted for credit, CSUN

Math 7 - COLLEGE ALGEBRA AND TRIGONOMETRY

5 Units

Prerequisites: Math 2 and Math 3 or plane geometry and one
and one-half year of high school algebra.
5 hours lecture weekly.

An integrated course in college algebra and trigonometry designed to prepare the student for calculus with analytic geometry. Real number systems, sets, inequalities, systems of equations and inequalities, matrices and determinants, functions and relations, circular functions, trigonometric functions and applications, inverse relations, complex numbers, exponential and logarithmic functions, theory of equations, sequences and series, mathematical induction and binomial theorem. (F,S)

Equivalent to Math 105, CSUN
Maximum of 3 units, UC (all branches)

Math 9A/B/C - FUNDAMENTALS OF MATH**1-1-1Units**

Prerequisite: None
3 hours lecture weekly

Student will enroll simultaneously in 9A, 9B, and 9C.

Math 9A - Review of addition, subtraction, multiplication and division of whole numbers, prime numbers, and prime factors, introduction to exponential-notation, operations with fractions and mixed numbers, use of fractions in ratio and proportion.

Math 9B - Decimal fractions, operations with decimal fractions, relation to common fractions, rounding off, scientific notation. Measurement -- units of length, area and volume -- metric and English systems. Percent, commission, discount, taxes, solution of business problems.

Math 9C - Weights and measures, more about the metric system, area and volume. Changing from English to metric units and vice-versa. Techniques for problem solving with emphasis in business, and practical problems. Operations with integers. Introduction to algebra.

Math 10 - PRINCIPLES OF MATHEMATICS**3 Units**

Prerequisites: Math 1 and Math 2 or plane geometry and one year high school algebra. (Math 2 may be taken concurrently)
3 hours lecture weekly.

Language of sets; systems of numeration; the nature of numbers and the fundamentals of operations; the domain of integers; the fields of rational, real and complex numbers. Will satisfy credential requirements for elementary and junior high teachers and/or general education option under basic studies. Not open to students majoring in the physical sciences or mathematics. (F)

Equivalent to Math 210, CSUN
Accepted for credit, UC (all branches)

Math 12 - COLLEGE ALGEBRA WITH BUSINESS APPLICATIONS**3 Units**

Prerequisites: Math 2 and Math 3 or plane geometry and one and one-half years of high school algebra.
3 hours lecture weekly.

Topics from college algebra with applications to problems in business and economics. Review of the real number system, algebra of sets, linear quadratic, exponential and logarithmic functions, equations, solution of inequalities, solutions of linear systems, operational vector and matrix algebra, introduction to differential and integral calculus, permutations, combinations and probability.

Equivalent to Math 103, CSUN
Accepted for credit, UC (all branches)

Math 13 - MATHEMATICS APPRECIATION**3 Units**

Prerequisites: Satisfactory score on Placement Test
3 hours lecture weekly

A course intended to give general students a better understanding of the nature of mathematics, the character and development of different subject fields, and the thinking process involved in doing mathematics rather than simple manipulation of symbols. Typical topics will include puzzles in mathematics, topology, geometry, probability, statistics, etc.

Equivalent to Math 131, CSUN
Accepted for credit, UC (all branches)

Math 14 - FINITE MATHEMATICS**3 Units**

Prerequisites: Math 12 or Math 7 or plane geometry and two years of high school algebra.

3 hours lecture weekly.

For students of managerial, social, or behavioral sciences. Laws of deductive reasoning, the algebra of sets, partitions and counting, probability, the algebra of vectors and matrices, applications to linear programming and the behavioral sciences.

Equivalent to Math 260, CSUN

Accepted for credit, UC (all branches)

Math 15 - INTRODUCTORY STATISTICS**4 Units**

Prerequisite: Math 3 or one and one-half years of high school algebra
4 hours lecture weekly

The Nature of Statistical Methods. The description of sample data, probability, theoretical frequency distributions, sampling, estimation, testing hypothesis, correlation, regression, special topics.

Equivalent to Math 140, CSUN

Accepted for credit, UC (all branches)

Math 16A - APPLIED CALCULUS I**3 Units**

Prerequisites: Math 7 or Math 12 or two years of high school algebra
3 hours lecture weekly

This is the first semester of a short course in calculus. Topics include: algebra review; elements of analytic geometry; functions of one variable; graphing; limits; continuity; sequences; techniques of differentiation; the differential; maxima and minima; introduction to integration; applications to social science, biological science, economics, business administration, architecture and technology.

Equivalent to Math 225A, CSUN

Accepted for credit, UC (all branches)

Math 16B - APPLIED CALCULUS II**3 Units**

Prerequisites: Math 16A or Math 25A or one year of high school calculus
3 hours lecture weekly.

A continuation of Math 16A. Topics include: definite, indefinite and improper integrals; logarithmic and exponential functions; trigonometric functions; techniques of integration; introduction to multi-variable calculus; introduction to differential equations; applications to social science, biological science, economics, business administration, architecture and technology.

Equivalent to Math 255B CSUN

Accepted for credit, UC (all branches)

Math 18 - COMPUTER PROGRAMMING-FORTRAN**3 Units**

Prerequisites: Math 3 or one and one-half years of high school algebra
3 hours lecture weekly

Familiarization with basic computer programming concepts utilizing the latest computer hardware. Designed to introduce physical science, life science, social science, business, engineering and mathematics students to the computer in problem solving, emphasizing the use of FORTRAN IV language and debugging of practice programs.

Equivalent to Math 281, CSUN

Accepted for credit, UC (all branches)

Math 20 - INTRODUCTION TO NUMERICAL METHODS

3 Units

Prerequisites: Math 18 and Math 16A OR Math 18 and Math 25A
3 hours lecture weekly

Error Analysis; Power Series Calculation of Functions; Roots of Equations, Nonlinear simultaneous equations; Matrices, Determinants, and linear simultaneous equations; numerical integration; interpolation and curve fitting. These numerical methods will be practically applied on the IBM 360 using FORTRAN IV. (Co-number DP 20)

Accepted for credit, UC (all branches)

Math 22A/B - DIRECTED STUDIES IN MATHEMATICS

1-3/1-3 Units

Prerequisites: A course in the proposed field of study with a recommending grade, consent of the instructor and Division approval

1-3 hours tutorial weekly

For students who desire to do further work in the field of mathematics on an independent basis. Course will involve library work and study on selected problems pertinent to the student's interest area.

Maximum of 3 units, CSUN

Math 25A - CALCULUS WITH ANALYTIC GEOMETRY I

5 Units

Prerequisites: Math 7 with a grade of C or better, or two years of high school algebra and trigonometry.

5 hours lecture weekly.

The real number system; elements of analytic geometry; functions, limits and continuity; differentiation and integration of algebraic and elementary transcendental functions with applications.

Equivalent to Math 150A CSUN

Accepted for credit, UC (all branches)

Math 25B - CALCULUS WITH ANALYTIC GEOMETRY II

5 Units

Prerequisite: Math 16B or Math 25A with a grade of C or better

5 hours lecture weekly.

Techniques of integration; vectors and operations with vectors in n-space; Cramer's Rule; complex numbers; partial differentiation; the gradient; multiple integration; curves in n-space; arc length, conic sections; polar coordinates.

Equivalent to Math 150B, CSUN

Accepted for credit, UC (all branches)

Math 25C - CALCULUS WITH ANALYTIC GEOMETRY III

5 Units

Prerequisites: Math 25B with a grade of C or better

5 hours lecture weekly

Introduction to differential equations, infinite sequences and series, Taylor's Theorem and topics in the Calculus of several variables such as affine transformations, Jacobi's Theorem, Green's theorem, Divergence theorem and the theorem of Stokes.

Equivalent to Math 250, CSUN

Accepted for credit, UC (all branches)

Math 30 - INTRODUCTION TO MODERN ALGEBRA

3 Units

Prerequisites: Math 25A and permission of instructor

3 hours lecture weekly

An introduction to set theory, finite groups and their structure.

Accepted for credit, UC (all branches)

Math 31 - INTRODUCTION TO LINEAR ALGEBRA

3 Units

Prerequisites: Math 25B and permission of instructor
3 hours lecture weekly.

Systems of linear equations, matrices, determinants, real vector spaces, linear transformations, eigenvector theory, with emphasis on understanding mathematical theory, relations, functions, mappings, groups, rings, integral domains, fields, number systems. Designed to prepare student for additional mathematical studies in upper division university courses. (S)

Equivalent to Math 262, CSUN
Accepted for credit, UC (all branches)

Math 33 - INTRODUCTION TO ANALYSIS

3 Units

Prerequisites: Math 25C and permission of instructor
3 hours lecture weekly.

Elements of real analysis and set theory with emphasis on attaining a thorough understanding of the basic concepts of set theory, algebra and topology of the real numbers, limits, continuity, relations, functions, mappings, groups, rings, integral domains, fields, number systems. (S)

Accepted for credit UC (all branches)
Accepted for credit, CSUN

Math 35 - APPLIED DIFFERENTIAL EQUATIONS

3 Units

Prerequisite: Math 25B and permission of instructor
(Math 30, Math 31 or Math 33 may be taken concurrently)
3 hours lecture weekly

Linear differential equations, equations with constant coefficients, variation of parameters, Green's functions, Laplace transform, systems of linear equations, series solutions, first order differential equations, existence and uniqueness of solutions with emphasis on applications to physics and engineering. (S)

Equivalent to Math 280, CSUN
Accepted for credit, UC (all branches)

Math 41A/B/C - MODERN SCHOOL MATH FOR PARENTS

1-1-1 Unit

Prerequisites: None
3 hours lecture (six weeks)

Study of selected topics from the Elementary school curriculum. Topics will be drawn from the state textbooks for Elementary schools. Ideas of sets, number systems, etc. will be studied.

Math 44 - BUSINESS MATHEMATICS

3 Units

Prerequisites: Math 9B or equivalent (may be taken concurrently)
3 hours lecture weekly.

A review of fundamental arithmetic and algebraic processes with application to business problems. Fractions, decimals, skills in areas of mark-up, discounts, interest installment debt and other business practices are presented. NOTE: This course meets the mathematics general education requirement for graduation. (Co-number Bus 44).

Math 45A - SLIDE RULE

1 Unit

Prerequisites: None
2 hours lecture weekly (1st 8 weeks)

Use of all 33 scales of a Log Log Decitrig Slide Rule; mathematical principles involved in the construction and use of the various scales. (Co-numer Engr 45A)
Accepted for credit, CSUN

Math 45B - SMALL COMPUTERS AND CALCULATORS

1 Unit

Prerequisites: Knowledge of basic algebra (high school algebra or Math 1)

2 hours lecture weekly (2nd 8 weeks)

Introduction to small computer arithmetic and techniques of problem solution using programmable calculators. Use of calculator, plotter, other accessories. Programming. Also includes instruction in use of pocket electronic calculators. Emphasis is on "hands-on" experience. (Co-number Engr 45B)
Baccalaureate Level

Math 48A/B/C/D - MATHEMATICS PRACTICUM

1-3 Units

Prerequisites: Math 3 (May be taken concurrently) and instructor approval
3-9 hours weekly in math learning center.

On-the-job training without financial compensation in the math learning center as an instructor aide under the continuous direction and supervision of a college mathematics instructor. Prior to enrollment in the course, the student must meet with a Math 9ABC or Math 1AB instructor for approval and assignment to his class.

For information regarding Work Experience credit in the Mathematics program, refer to Page 224 in this catalog.

mexican-american studies

Faculty: Frank Fierro, Joe Gonzalez, Diana Ho, Carlos Ramirez, Amado Reynoso



Students enrolled in this curriculum will be involved in an intensive study of Mexican-American history and culture. Emphasis is placed on contemporary political, social and economic problems, as well as on the art, literature, and language of the Mexican-American. Successful completion of the program prepares students for work in the barrio, teaching, politics, social services and various forms of governmental employment and private industry.

REQUIRED COURSES IN THE MAJOR

California State University, Northridge		University of California, Santa Barbara	
MAS 1	Mexican-American in Contemporary Society	MAS 1	Mexican-American in Contemporary Society
MAS 2	Mexican-American Culture	MAS 2	Mexican-American Culture
MAS 4A/B	History of Mexican People in the Southwest		
MAS 6	Mexican-American Literature in Translation		

courses in mexican-american studies

MAS 1 - MEXICAN-AMERICAN IN CONTEMPORARY SOCIETY **3 Units**

Prerequisite: Satisfactory score on placement test or consent of instructor.
3 hours lecture weekly.

An analysis of the socio-economic and political problems confronting the Mexican-American with emphasis on proposed solutions. Particular focus will be placed on the effects the social institutions have had on the Mexican-American community. Special emphasis will be placed on the school system. (This course will count toward Social Science or general education credit). (F) (Co-number Soc 6)
Accepted for credit, UC (all branches)
Equivalent to Chicano Studies 200, CSUN

MAS 2 - MEXICAN-AMERICAN CULTURE **3 Units**

Prerequisites: Satisfactory score on placement test or consent of instructor.
3 hours lecture weekly.

The social and cultural heritage of the Mexican-American, emphasizing middle American civilizations, and including the evolution of the Mexican-American from the Spanish conquest to present day America. The course is concerned with the contributions made by the Mexican-Americans to the United States, especially in the fine arts, literature, and orally transmitted heritage. (This course will count for elective credit in the Humanities area.) (Co-numbered Anth 4) (F,S)
Accepted for credit, UC (all branches)
Equivalent to Chicano Studies 100, CSUN

MAS 3A/B - SPANISH FOR THE SPANISH SPEAKING **4-4 Units**

Prerequisite: A speaking knowledge of the Spanish language.
5 hours lecture, 1 hour laboratory weekly.

The methodical presentation of the basic communication skills of Spanish for students who are from Spanish speaking backgrounds. Emphasizing vocabulary building and conversation, both semesters increase proficiency in understanding, speaking, reading and writing Spanish. Special attention is focused on correct grammar and written communications for the Mexican-American. (Co-numbered Spn 3A/B)
Equivalent to Chicano Studies 101 and 102, CSUN
Accepted for credit, UC (all branches)

**MAS 4 - HISTORY OF THE MEXICAN PEOPLE IN THE
SOUTHWEST**

3 Units

Prerequisites: Satisfactory score on Placement Test
or consent of instructor.

3 hours lecture weekly

A survey of the history of the Mejicano from the pre-Columbian period to the present. Emphasis will be on the Mexican settlement of the region and the contributions of the Mejicano to the development of the five Southwestern states (Arizona, California, Colorado, New Mexico and Texas). (Co-number Hist 4) (F,S)
Accepted for credit, UC (all branches)

MAS 7 - FIELD WORK IN BARRIO STUDIES

3 Units

Prerequisite: Completion of MAS 1 or consent of instructor
1 hour lecture, 6 hours laboratory weekly

Field study observation of selected barrios, institutions, and agencies to be conducted under supervision and after preparatory instruction to acquaint students with the barrio. (Co-number Soc 7)

MAS 8 - POLITICAL PATTERNS IN THE U.S.

3 Units

Prerequisites: Satisfactory score on Placement Test
3 hours lecture weekly

An analysis of the political participation of La Raza in the United States. Special attention will be focused on the political responses of Chicanos, Puerto Ricans and Native American Indians to their subordinate position in the United States. Course fulfills the State requirements for study of American Institutions. (Co-number Pol Sci 8)

Accepted for credit, UC (all branches)

MAS 13A/B - CONTEMPORARY MEXICAN-AMERICAN THEATRE

1-3 Units

Prerequisites: Satisfactory score on Placement Test
A - 3 hours lecture weekly
B - 3 hours laboratory weekly

Through theatre and music, studying and presenting the Chicano community and movement. (Co-number ThA 11A/B)
Accepted for credit, UC (all branches)

MAS 22A/B - DIRECTED STUDIES- MEXICAN-AMERICAN

1-3/1-3 Units

Prerequisite: Consent of the instructor
1-3 hours laboratory weekly.

Designed for selected students who are interested in furthering their knowledge of Mexican-American studies on an independent studies basis. Assigned problems will involve library, laboratory and field work. Maximum of 3 units.

It is difficult to imagine our world without music. A career in music today may involve performing solo, or in ensembles, as well as accompanying and conducting in such fields as radio, television, and the recording industry. Although most instrumental musicians play only one instrument, many are qualified to play two or more. As a rule, these musicians also specialize in either classical or popular music, only a few play both types professionally. Many musicians, in addition to their work as performers, give private lessons and/or teach in our schools. Some are employed in hospitals working in the field of music therapy, while others work in music libraries.

REQUIRED COURSES IN THE MAJOR

California State University, Northridge
 Mus 2A/2B Music Theory
 Mus 9A/9B Music History/Lit
 Mus 12-21 Vocal/Instrum/Ensem

University of California, Santa Barbara
 Music 2A/2B Music Theory
 Mus 9A/9B Music History/Lit
 Mus 24 Piano
 For Lan Foreign Language
 (3 semesters or 5 quarters)
 German or French
 recommended

courses in music

Mus 1 - FUNDAMENTALS OF MUSIC

3 Units

Prerequisite. None.
 3 hours lecture weekly.

Designed for the student with little or no prior understanding in music who wishes to learn to read music. Course objective is to gain a basic understanding of scales, intervals, chords, key signatures, time signatures, musical symbols, and an introduction to the piano keyboard.
 Accepted for credit, UC (all branches)

Mus 2A/2B/2C/2D - THEORY

4-4-4-4 Units

Prerequisite. Music 1 or equivalent
 5 hours lecture weekly

This course is concerned with: 2A) Major and Minor scales (structure) all keys - primary chords and their inversions in all keys, chord progressions, modulation by pivot chord to the keys of the dominant and the relative, minor, and other closely related keys. 2B) the dominant seventh chord and its inversions, secondary dominants and dominant sevenths - secondary non-dominant sevenths, diminished sevenths, complete and incomplete dominant ninths, and more remote modulation. 2C) chromatic harmony, augmented 6th chords, the Neopolitan 6th chord, eleventh and thirteenth chords, and basic use of binary and ternary forms - accompanimental figures and basic orchestration. 2D) counterpoint (tonal) the five species, free counterpoint, Canon at the octave, 2nd, 3rd, 4th, 5th, 6th and 7th, modulatory episodic writing - culminates in two part invention writing. Students should enroll in Music 3A when taking either Music 2A or Music 2B.
 Equivalent to Music 120A/B, 220A/B, CSUN
 Accepted for credit, UC (all branches)

Mus 3 - MUSIC READING AND MUSICIANSHIP

2 Units

Prerequisites: None

2 hours lecture, 1 hour laboratory weekly

Course is designed to teach the techniques of reading music and fundamental musicianship. Work covers rhythmic and pitch notations, reading of graded song and choral literature, and melodic and rhythmic dictations.

Mus 5 - SURVEY OF CONTEMPORARY MUSIC

2 Units

Prerequisites: None

2 hours lecture weekly.

Designed to present a comprehensive survey of jazz, rock, electronic and other styles of current music in the Los Angeles area. Student involvement and research in class presentations required.

Accepted for credit, UC (all branches)

Mus 8 - MUSIC APPRECIATION

3 Units

Prerequisite: None

3 hours lecture weekly.

Survey of musical history with special emphasis on the understanding and enjoyment of music; introduction to the formal principles employed in music.

Equivalent to Music 105, CSUN

Accepted for credit, UC (all branches)

Mus 9A - MUSIC HISTORY AND LITERATURE

3 Units

Prerequisite: Satisfactory score on Placement Test

3 hours lecture weekly.

This course traces the changes of style and the technique of music composition from Gregorian chant through such developments as medieval organum; the secular song and dance music of the Middle Ages and Renaissance; the polyphony of Dufay, Josquin, Lassus, and Palestrina; the Italian and English madrigal, the Baroque opera and concerto grosso through the 18th-Century contributions of Vivaldi, Handel, and Bach. The emphasis is on listening and analyzing for style characteristics and on the correlation of musical developments with those in the other arts of the time. Recommended for music majors.

Equivalent to Music 201A, CSUN

Accepted for credit, UC (all branches)

Mus 9B - MUSIC HISTORY AND LITERATURE

3 Units

Prerequisite: Satisfactory score on Placement Test

3 hours lecture weekly.

A study of the changing styles, techniques, and forms of music from the middle of the 18th Century to the present. Special emphasis is placed upon the artistic philosophy of each style period. Music is studied as one of the humanities, but intensive consideration is also given to the analysis of style and form in other musical works. Recommended for music majors.

Equivalent to Music 201B, CSUN

Accepted for credit, UC (all branches)

***Mus 10 - CONCERT CHOIR**

2 Units

Prerequisite: Consent of instructor
1 hour lecture, 3 hours rehearsal weekly

The learning and performing of choral music for all interested men and women. The choir participates in musical events on campus and in the surrounding community.
Equivalent to Music 184, CSUN

***Mus 11 - CHAMBER CHOIR**

1 Unit

Prerequisites: Consent of instructor
3 hours laboratory weekly.

A choir which performs choral literature suitable for a smaller number of singers. Repertoire may include works of Renaissance composers to those of the modern and contemporary periods. Public performance is expected.

***Mus 12 - VOCAL ENSEMBLE**

1 Unit

Prerequisite: Consent of instructor
3 hours rehearsal weekly.

A select group of singers who study and perform literature suitable for a small ensemble. Emphasis is placed on madrigal singing. Public performance is required.
Baccalaureate Level

Mus 13A - FUNDAMENTALS OF VOCAL TECHNIQUE

2 Units

Prerequisite: None
1 hour lecture, 3 hours rehearsal weekly

Designed to begin development of the vocal potential, to lay a foundation for proper vocal production, and to correct faulty singing. Material will consist of song literature sung in English in addition to vocal exercises. Basically for non-music majors or for persons with little singing experience.

Mus 13B - VOCAL DEVELOPMENT AND THE ART SONG

2 Units

Prerequisite: Mus 13A or consent of instructor
1 hour lecture, 3 hours rehearsal weekly.

A continuation in developing a proper vocal production. Material to be studied will consist of English, Italian, German, French art songs. It is recommended that singers with proven adequate vocal technique may begin with this class.

Mus 13C - VOCAL DEVELOPMENT AND THE ARIA

2 Units

Prerequisites: Mus 13B or consent of instructor
1 hour lecture, 3 hours rehearsal weekly

A continuation of vocal development through a study of more challenging literature in the form of the aria from composers such as Bach, Handel, Mendelssohn, and Mozart. Songs from contemporary American composers such as Barber, Copland, Rorem, and Diamond may also be studied.

Mus 13D - VOICE IN OPERA WORKSHOP **2 Units**
Prerequisite: Mus 13C or consent of instructor
1 hour lecture, 3 hours rehearsal weekly.

The study of song literature taken from the musical theatre. The course work will consist of the studying and performing of opera and musical plays in excerpt or as a complete production. Class designed for singers with proven ability with interest in drama.

Mus 13 A, B, C and D equivalent to Mus 188 &
Mus 238, CSUN

Mus 14 - MEN'S GLEE CLUB **2 Units**
Prerequisites: Consent of instructor
1 hour lecture, 3 hours laboratory weekly.

The study of proper vocal technique. The study and performance of choral music for the male voice.

***Mus 15 - ORCHESTRA** **1 Unit**
Prerequisite: Consent of instructor,
3 hours rehearsal weekly.

Preparation and performance of orchestral repertoire.
Equivalent to Music 182, CSUN

Mus 17 - ACTIVITIES BAND **1 Unit**
Prerequisites: Competence with a musical instrument
3 hours activity weekly

Reading, preparation and performance of music arranged for special events of the college community. (Athletic, student activities, festivals and events). Rehearsal for and performance at special events is required. Does not meet the Fine Arts requirement for A.A. Degree nor Humanities Group A for the transfer G.E. requirement.

***Mus 18 - STUDIO BAND** **2 Units**
Prerequisite: Competence with a musical instrument
6 hours rehearsal weekly

Reading, preparation and performance of music arranged for studio band. Rehearsal for and performance at scheduled concerts is required.
Equivalent to Music 180, CSUN

***Mus 19 - CONCERT BAND** **1 Unit**
Prerequisite: Competence with a musical instrument
3 hours rehearsal weekly.

Rehearsal and performance of representative concert band literature.

***Mus 21 - BRASS ENSEMBLE** **1 Unit**
Prerequisite: Competence with a musical instrument
3 hours rehearsal weekly

Study and performance of standard and modern compositions and arrangements for brass ensemble.
Equivalent to Music 287, CSUN

Mus 22A/B - DIRECTED STUDIES IN MUSIC**1-3/1-3 Units**

Prerequisites: A course in the specific field and the consent of the instructor and Division Chairman
1-3 hours tutorial weekly.

Designed for selected students who are interested in furthering their knowledge of music on an independent study basis. Assigned problems will involve library, laboratory and field work. Maximum of 6 units.
Maximum of 3 units, CSUN

Mus 23A - WOODWIND ENSEMBLE*1 Unit**

Prerequisites: Proficiency with instrument and permission of instructor
3 hours rehearsal weekly

The study, rehearsal and performance of music literature for instruments in the woodwind family.

Mus 23B - STRING ENSEMBLE*1 Unit**

Prerequisites: Proficiency with instrument and permission of instructor
3 hours rehearsal weekly

The study, rehearsal and performance of music literature for the string ensemble.

Mus 24A/B/C/D - PIANO**2-2-2-2 Units**

Prerequisite: None for Mus 24A, 24A for 24B, 24B for 24C, 24C for 24D.
1 hour lecture, 3 hours rehearsal weekly.

24A - Fundamentals of piano playing, note reading, finger drills, scales and simple piano literature.

Equivalent to Music 132A, CSUN

24B - Piano studies and techniques for steps two and three; continuation of scales and keyboard techniques.

Equivalent to Music 132B, CSUN

24C - Piano studies and literature for students for fourth and fifth steps; scales and keyboard techniques.

Equivalent to Music 232A, CSUN

24D - Emphasis on keyboard harmony and techniques; harmonization of melodies with different style accompaniments, transposition, improvisation of various forms, modulation, playing by ear, scales, chords, reading choral scores.

Equivalent to Music 232B, CSUN

Mus 26 - RECORDER ENSEMBLE*1 Unit**

Prerequisite: Consent of instructor
3 hours rehearsal weekly

The study and performance of music literature for a recorder flute ensemble of soprano, alto, tenor, and bass instruments. Combinations may include recorders, voices, harpsichord, or other early instruments.

Mus 27 - CHORAL CONDUCTING**2 Units**

Prerequisites: Equivalent of Mus 1, Mus 2 or by permission of instructor
2 hours lecture, 1 hour laboratory weekly.

Basic conducting techniques; exploration of choral literature including style, performance, interpretation; conducting singing groups utilizing the research and techniques. (F,S) EVENINGS ONLY

Mus 28 - INSTRUMENTAL CONDUCTING**2 Units**

Prerequisites: Equivalent of Mus 1, Mus 2 or by permission of instructor

2 hours lecture, 1 hour laboratory weekly.

Basic conducting techniques of various instrumental organizations; exploration of instrumental literature, including style, performance, interpretation. (F,S) EVENINGS ONLY

Mus 29 - INTRO TO AMERICAN FOLK MUSIC**3 Units**

Prerequisites: None

3 hours lecture weekly

A survey of American folk and traditional music, from early America to the present. Emphasis on listening to and analysis of different types of folk music, such as regional music, music of minorities, protest music, ballads, country music, etc. Study of various folk instruments, live performances, films and recordings.

Mus 32 - BEGINNING GUITAR**1 Unit**

Prerequisites: None

3 hours laboratory weekly (8 weeks)

Theory and practice of the Guitar.

*Course may be repeated for credit up to 4 times.

personal growth

The Personal Growth program provides the opportunity for people to meet in small groups in order to share mutual concerns. These people are given a chance to expand personal communication and work toward problem solving in an informal atmosphere with a professional counselor as facilitator.

PG 2 - CAREER DEVELOPMENT**1½ Units**

Prerequisite: None

3 hours lecture weekly (8 weeks)

This class assists one in systematically examining the components of career choice. The class will focus on career awareness, personal awareness, and educational awareness as they relate to the process of career choice. Planning skills and self-assessment instruments will help identify tentative career possibilities.

PG 1 - RAP FOCUS**½ Unit**

Prerequisite: None

1½ hours seminar weekly (8 weeks)

Each semester a variety of RAP groups focusing on specific topics is offered. The group meetings provide an opportunity to share thoughts, feelings, and concerns in such areas as marriage, human sexuality, women's awareness, or personal communication in a small group of people with similar interests. The Schedule of Classes lists the specific focus topics offered each semester.



philosophy

Faculty: Paul Fink

Nearly everyone is committed to a set of general principles, beliefs, and attitudes which constitutes his "philosophy of life," and which provides both a framework and a rationale for his existence. Not everyone, however, has taken the time to critically evaluate his position or to systematically consider alternative viewpoints. Philosophy courses provide an opportunity to do this by reviewing many of the theories, insights, and arguments that have been advanced by leading thinkers through the ages. Hopefully, then, the study of philosophy may help the student to develop a more well-reasoned view concerning man and his place in the universe, and a more mature set of values with which to guide his conduct.

REQUIRED COURSES IN THE MAJOR

California State University, Northridge

Phil 1A/B Intro to Philosophy
Phil 2 Intro to Logic

University of California, Los Angeles

Phil 1A/B Intro to Philosophy
Phil 2 Intro to Logic
For Lan Foreign Language

courses in philosophy

Phil 1A/B - INTRODUCTION TO PHILOSOPHY

3-3 Units

Prerequisite: Satisfactory score on Placement Test
3 hours lecture weekly.

Philosophy 1A/B consists in a broad survey of the various problems and positions of philosophy. In Philosophy 1A an attempt is made to clarify the nature of the philosophic enterprise and to focus attention upon some of the central issues of epistemology, metaphysics, and political philosophy. Philosophy 1B deals mainly with the problems of moral philosophy, but also involves the study of related views concerning the nature of man, society, and the universe. Together these courses are designed to provide the student with an understanding of a number of arguments and insights that should prove to be helpful in the task of constructing an adequate philosophy of life. The two courses are independent and may be taken concurrently.

Equivalent to Phil 150, 160, CSUN
Accepted for credit, UC (all branches)

Phil 2 - INTRODUCTION TO LOGIC

3 Units

Prerequisite: Satisfactory score on Placement Test
3 hours lecture weekly

Logic involves a study of the patterns of deductive and inductive thought. The purpose of the course is to encourage the student to master the techniques required to engage in clear, consistent, and cogent reasoning. An attempt is made to review immediate, syllogistic, and extended forms of deductive inference as well as arguments by analogy, inductive generalizations, and scientific hypotheses. The emphasis of the course is practical rather than theoretical; attention is directed towards an application of logical techniques in the solution of every-day problems and in the appraisal of the kinds of arguments that we daily encounter.

Equivalent to Phil 100, CSUN
Accepted for credit, UC (all branches)

Phil 3 - COMPARATIVE RELIGIONS

3 Units

Prerequisite: Satisfactory score on Placement Test
3 hours lecture weekly

Philosophy 3 consists of a systematic study of the major religions of the world. Hinduism, Buddhism, Jainism, Taoism, Confucianism, Zen, Zoroastrianism, Judaism, Christianity, and Islam are among the positions reviewed. In each instance an attempt is made to learn to view the religion from the standpoint of its proponents. The purpose is to promote a broader understanding of the main similarities and differences which these outlooks exhibit, and to acquire an appreciation of their historical connections.

Accepted for credit, CSUN
Accepted for credit, UC (all branches)

Phil 10 - CONTEMPORARY BLACK THOUGHT

3 Units

Prerequisites: Satisfactory score on Placement Test
3 hours lecture weekly.

Philosophy 10 consists in a careful review of the ideas advanced by a number of the more influential Black writers in this century. The purpose is to promote an increased understanding of the problems and issues with which they are concerned, and to investigate the solutions which they have proposed. An attempt will be made to consider a variety of viewpoints while concentrating attention on the more philosophical aspects of each position. The authors studied will include: Fanon, Baldwin, King, Malcolm X, Carmichael, Hamilton, and Cleaver.

Accepted for credit, CSUN

Phil 11 - PSYCHOLOGY OF RELIGION - EAST AND WEST

3 Units

Prerequisites: Satisfactory score on Placement Test
3 hours lecture weekly

Discussion of the more provocative emphasis to be found, correlatively, in the Upanishads, Tao te Ching, Bhagavad-Gita, Dhammapada, and Old and New Testaments. An inquiry into the philosophy of essential religion.

Phil 12 - RELIGION, VALUES & PEAK EXPERIENCES

3 Units

Prerequisites: Satisfactory score on Placement Test
3 hours lecture weekly

The title of the late Abraham H. Maslow's widely distributed work serves as a focus on inquiry for this course. Maslow's pioneering endeavors in "Third Force Psychology," will be examined as well as his rise from an obscure researcher to the President of the American Psychological Association. An account will be given of crucial shifts made in metaphysical and psychological emphasis as a result of the work of such men.

Baccalaureate Level

Phil 13 - ETHICS IN A SOCIAL CONTEXT

3 Units

Prerequisites: None
3 hours lecture weekly

An introduction to the problems of Social Ethics. Dealing with issues of war, violence, capital punishment, property and welfare, power and politics. A case study approach will be used. Various approaches to ethics will be discussed, including legalism and situational ethics. The views of prominent thinkers will be introduced, including Buber, Tillich, John Locke, J. S. Mill, Herbert Marcuse, and Reinhold Niebuhr. The class will discuss and evaluate personal viewpoints upon current moral attitudes and issues.

Baccalaureate Level

**Phil 15 - CONTEMPORARY RELIGIONS AND PHILOSOPHIES:
A CROSS-SECTION**

3 Units

Prerequisites: None
3 hours lecture weekly

A course designed to explore the flourishing contemporary spiritual/religious/philosophical groups in Southern California through literature, participation, visits and discussion.
Baccalaureate Level

**Phil 16 - PHILOSOPHY OF SELF-AWARENESS, EAST
AND WEST**

3 Units

Prerequisites: None
3 hours lecture weekly

Study of self-awareness as developed in Western and Eastern cultures. Sufism, Gestalt, Taoism, Zen and Body Awareness will be covered from the point of view of the psycho-medicinal arts.
Baccalaureate Level

Phil 22A/B - DIRECTED STUDIES IN PHILOSOPHY

1-3/1-3 Units

Prerequisites: A course in the specific field with a recommending grade and consent of instructor and Division Chairman

1 - 3 hours tutorial weekly.

Designed for selected students who are interested in furthering their knowledge of philosophy on an independent study basis. Assigned problems will involve writing and research.
Maximum 3 units credit, CSUN



photography

Faculty: John Gray



The Photography curriculum is designed for the student who wants to better understand photographic communication and for those students who want to make professional photography their vocational field. Previous experience in photography is not required.

Emphasis is placed on developing each student's own ingenuity and creativity through a series of classes that concern themselves with both technical and aesthetic problems.

REQUIRED COURSES IN THE MAJOR

FIRST SEMESTER

Art 4A	Color and Design
Photo 1A	Beginning Photography
Art 12A	Drawing

SECOND SEMESTER

Art 4B	Color and Design
Photo 1B	Beginning Photography
Art 12B	Drawing
Cine 1A	History of the Cinema

THIRD SEMESTER

Art 4C	Color and Design
Photo 3	Basic Color Photo
Art 13A	Life Drawing
Art 1A	Art History

FOURTH SEMESTER

GC 4	Layout and Design
Photo 4	Advanced Photography
Photo 8	Photo Journalism
Art 1B	Art History

OPTIONS

Cine 2A/2B	Art and Technique of Film
------------	---------------------------

Photo 1A - BEGINNING PHOTOGRAPHY**3 Units**

Prerequisites: None

2 hours lecture, 3 hours laboratory weekly.

A beginning course in photographic theory. Emphasis on photography as a means of creative expression, including a study of the basic principles of camera operation, exposure, developing and printing, basic color techniques.

Equivalent to Art 250, CSUN

Photo 1B - BEGINNING PHOTOGRAPHY**3 Units**

Prerequisites: Photo 1A or consent of instructor on presentation of portfolio

2 hours lecture, 3 hours laboratory weekly

An extension of the techniques learned in Photo 1A, with further study of equipment and methods. 35 mm techniques and processes will be explored in depth.

Accepted for credit, CSUN

Photo 3 - BASIC COLOR**3 Units**

Prerequisites: Photo 1A, 1B or consent of instructor

2 hours lecture, 3 hours laboratory weekly

The principles of color photography, the use of correction filters. . . processing of transparency materials -- with emphasis on creative use of special effects achieved by unique lighting, films and camera techniques directed toward a more expressive visual statement. Experimental approach encouraged.

Accepted for credit, CSUN

Photo 4 - ADVANCED PHOTOGRAPHY**2 Units**

Prerequisites: Photo 1A/B or equivalent

1 hour lecture, 3 hours laboratory weekly.

An extension of the techniques learned in Photo 1, with further study of equipment and methods; emphasis on composition and experimental approaches to design elements and principles.

Baccalaureate Level

Photo 8 - BASIC PHOTO-JOURNALISM**5 Units**

Prerequisites: Photo 1A, or suitable portfolio and consent of instructor

2 hours lecture, 3 hours laboratory weekly.

Aspects of photography as applied to mass communication -- broadcast and print journalism. Concentration on the translation of ideas to images for reproduction in magazines, newspapers and book illustrations. Special effects and the utilization of camera and light as creative tools. Basic motion picture techniques. (Co-number Journ 8)

Accepted for credit, CSUN

NOTE: 6 units credit accepted, CSUN

For information regarding Work Experience credit in the Photography program, refer to Page 224 in this catalog.

courses in photography

physical education



Faculty: Don Brockett, Paul Dunham, Division Chairman; Marty Hardy, John Keever, Modean McCullough (on leave '73-'74), Kathy Mason, Gilbert Mendoza, Linda Moore, Alvyn Nordquist, Delbert Parker, George Ragsdale, Manuel Trevino

The physical educator plays an ever-increasing role of importance in a society preoccupied with automation and cybernetics. Physical Education provides an opportunity to motivate, organize, and teach the social, emotional, and physical aspects of man. The major in physical education is designed for students who (1) plan to teach physical education, or (2) expect to become physical education leaders in public or private programs, and (3) plan to continue the study of physical education for an advanced degree.

REQUIRED COURSES IN THE MAJOR

California State Polytechnic College		California State University, Northridge	
PE 80,82	Professional Courses (Men)	PE 80, 82	Professional Courses (Men)
PE 84,86	Professional Courses (Men)	PE 84,86	Professional Courses (Men)
PE 81,83	Professional Courses (Women)	PE 81,83	Professional Courses (Women)
PE 85,87	Professional Courses (Women)	PE 85,87	Professional Courses (Women)
Rec 1A/B	Recreational Leadership	PE 93A/B	Woman's Sports Officiating
An 1	Human Anatomy	An 1	Human Anatomy
Phy 1	Intro to Human Physiology	Phy 1	Intro to Human Physiology
PE 90	Intro to Physical Education	PE 90	Intro to Physical Education
Speech 1	Intro to Speech	PE 35	Basic Dance Skills
Speech 2	Elements of Public Speaking	PE 36	Modern Dance (Women)
Biol 2A/B	General Biology	Biol 2A	General Biology

1. Physical Education is not a requirement for enrollment in the college. However, students who wish to earn an Associate of Arts Degree must successfully complete two semester units of Physical Education activity over four semesters.
2. Summer school P.E. classes may count toward fulfilling the requirement for the Associate of Arts Degree.

GRADUATION REQUIREMENTS FOR THE ASSOCIATE OF ARTS DEGREE

Exemptions & Petitions--A student may be exempted from the physical education activity requirement for graduation if (1) he or she has attained their 18th birthday prior to the first day of class or (2) if he or she has a medically excused disability approved by the school physician.

Repetition for Credit--The college policy for repeating courses for credit applies to ALL BEGINNING PHYSICAL EDUCATION ACTIVITY COURSES. You may repeat all intermediate and advanced courses along with varsity sports for additional course credit. Students are encouraged to enroll in a variety of activities which have carry-over value.

Uniform Requirements-- The uniform or costume appropriate for the course is required of all students. Standardized activity uniforms and other appropriate activity costumes are available in the student bookstore.

courses in physical education

PE 1 - BEGINNING BODY CONDITIONING

1½ Units

Prerequisites: None

1 hour lecture, 2 hours activity weekly

A course designed to increase the understanding of the principles of fitness and the development and maintenance of a high level of efficiency.

PE 2A/B - BEGINNING GYMNASTICS

1½-1½ Units

Prerequisite: None

1 hour lecture, 2 hours activity weekly

PE 2A: Fall Semester--Emphasis on body balance, tumbling, trampoline, and introduction to apparatus.

PE 2B: Spring Semester--Emphasis on the development of proficiency in the elementary skills of apparatus.

PE 3A/B - BEGINNING TEAM SPORTS

1 Unit

Prerequisites: None

3 hours activity weekly

Techniques, strategies, rules of team sports in season, with opportunity to participate in the intramural program.

PE 3A - Fall Semester--flag football, volleyball, basketball.

PE 3B - Spring Semester--basketball, soccer, rugby, softball.

PE 4 - BEGINNING WRESTLING

1½ Units

Prerequisites: None

1 hour lecture, 2 hours activity weekly

Introduction of wrestling as an educational medium which gives the student opportunity for self-expression. The student is taught takedowns, rides, escapes and falls.

PE 5 - EQUITATION

2 Units

Prerequisites: None

1 hour lecture, 3 hours laboratory weekly

Beginning riding techniques, care and use of horse and equipment, safety and first aid, types of riding and equipment, appreciation of the animal, and its relationship to the environment. (Co-number AH 8)

PE 6 - BEGINNING RUGBY

1½ Units

Prerequisites: None

1 hour lecture, 2 hours activity weekly

Development of skill in playing rugby. The course covers rules and the fundamental skills of passing, running, kicking, and tackling. Offensive and defensive strategy is also included in the course.

PE 7 - BEGINNING SOCCER

1½ Units

Prerequisites: None

1 hour lecture, 2 hours activity weekly

Development of skills in playing the game of soccer, including the rules, techniques and strategy of playing the game.

PE 8 - BICYCLE RIDING**1½ Units**

Prerequisites: Access to a lightweight bicycle.
1 hour lecture, 2 hours activity weekly

An introduction to cycling as a lifetime sport. To make the student aware of the physiological benefits derived from bicycling.

beginning women's activities**PE 10 - SELF-DEFENSE & BODY MECHANICS****1½ Units**

Prerequisites: None
1 hour lecture, 2 hours activity weekly

A course designed to increase the knowledge and understanding of the use of the body in its defense. Also involves the principles of fitness and body movements and the development and maintenance of a high level of efficiency.

PE 11A - BEGINNING GYMNASTICS - APPARATUS**1½ Units**

Prerequisites: None
1 hour lecture, 2 hours activity weekly

Development of proficiency in elementary skills of tumbling and gymnastics with emphasis on safety, basic understanding, and appreciation. Also emphasis on body balance, tumbling, trampoline and introduction to apparatus.

PE 11B - TUMBLING - FLOOR EXERCISE**1½ Units**

Prerequisites: None
1 hour lecture, 2 hours activity weekly

Development of proficiency in elementary skills of tumbling and gymnastics with principles of fitness and the development and maintenance of a high level of efficiency. Emphasis on the development of proficiency in the elementary skills of apparatus.

PE 12A - BEGINNING TEAM SPORTS FOR WOMEN**1 Unit**

Prerequisites: None
3 hours activity weekly

Techniques, strategies, rules of team sports in season, with opportunity to participate in the intramural program. Emphasis on flag football, volleyball, and basketball.

PE 13A - WRA VARSITY VOLLEYBALL FOR WOMEN**3 Units**

Prerequisites: None
1 hour lecture, 9 hours activity weekly

Open to women interested in competitive volleyball and competing in a junior college league. Instruction given in techniques, strategies and rules.

PE 13B - WRA VARSITY TRACK & FIELD FOR WOMEN**3 Units**

Prerequisites: None
1 hour lecture, 9 hours activity weekly

Open to women interested in competing in track and field events at the junior college level. Instruction in techniques and rules.

PE 14 - DYNAMIC FITNESS**1½ Units**

Prerequisites: None

1 hour lecture, 2 hours activity weekly

A course designed in conditioning exercises to improve body form and function. Corrective and therapeutic exercises selected to fill specific needs.

PE 17 - FIELD HOCKEY**1 Unit**

Prerequisites: None

3 hours lecture weekly

Rules, techniques and strategy of field hockey. The course covers the fundamental skills of dribbling, passing, and receiving. Positions, both offensive and defensive are learned.

beginning co-educational activities

PE 21 - SWIMMING FOR FITNESS**1½ Units**

Prerequisites: Basic swimming ability

1 hour lecture, 2 hours activity weekly

This course is designed to improve swimming techniques of swimmers. Emphasis will be placed on endurance training for improved cardiovascular fitness and weight control. Attention will also be given to survival techniques and emergency procedures.

PE 22A/B - DIRECTED STUDIES IN P.E.**1-3 Units**

Prerequisite: A course in the specific field and the consent of the instructor and Division Chairman

1 - 3 hours tutorial weekly

Designed for selected students who are interested in furthering their knowledge of physical education on an independent study basis. Assigned problems will involve library, laboratory, and field.

Maximum of 6 Units

PE 23 - BACKPACKING & OUTDOOR SURVIVAL**2 Units**

Prerequisites: Physical fitness level for mountain hiking and adequate backpacking equipment for participation.

1 hour lecture, 3 hours activity weekly

Introduction to backpacking, equipment, clothing, food and recipes, menus and food lists, cooking, safety and survival on the trail, in camp, ecology, preparation and participation in backpacking trips required.

PE 27 - CO-ED SOFTBALL**1 Unit**

Prerequisites: Good Health

3 hours activity weekly

Co-educational instruction and participation in the basic skills and strategy of slow pitch softball.

PE 28 - INTRODUCTION TO KARATE**1½ Units**

Prerequisites: None

1 hour lecture, 2 hours activity weekly

A course designed to teach the basic art of self-defense and insight into the meaning and origin of Karate.

PE 29 - JUDO**1½ Units**

Prerequisites: None
1 hour lecture, 2 hours activity weekly

Development of skill in the elementary fundamentals and techniques of judo. The course covers the rules and a brief history of the sport.

PE 30 - ARCHERY**1½ Units**

Prerequisites: None
1 hour lecture, 2 hours activity weekly

Development of skill in archery, including rules, etiquette, safety factors, and techniques of archery.

PE 31 - BEGINNING BADMINTON**1½ Units**

Prerequisites: None
1 hour lecture, 2 hours activity weekly

Development of skill in playing badminton, including rules, etiquette, techniques of playing badminton.

PE 32 - BOWLING**1 Unit**

Prerequisites: None
3 hours activity weekly

Development of skill in bowling, including rules, etiquette, safety features, and techniques. Class is conducted off campus at Simi Bowl.

PE 33 - GOLF**1½ Units**

Prerequisites: None
1 hour lecture, 2 hours activity weekly

Development of skill in playing golf. The course covers etiquette, rules, and techniques of playing golf. NOTE: The evening sections of golf meet only 2 hours and receive ½ unit.

PE 34 - TENNIS**1½ Units**

Prerequisites: None
1 hour lecture, 2 hours activity weekly

Development of skill in playing tennis. The course covers beginning skills, etiquette, rules and techniques of play.

PE 35 - SAILING**1½ Units**

Prerequisites: None
1 hour lecture, 2 hours activity weekly

An introduction to the theory and techniques involved in sailing small sloop rigged boats. An introduction to racing rules and tactics will also be included.

PE 36 - BEGINNING MODERN DANCE**1½ Units**

Prerequisites: None
1 hour lecture, 2 hours activity weekly

Development of proficiency of modern dance technique, skills and development of an understanding and appreciation of modern dance as an art form.

PE 37A/B - FOLK & SQUARE DANCE—ETHNIC DANCE 1½-1½ Units

Prerequisites: None

1 hour lecture, 2 hours activity weekly

Development of Ethnic dance skills, understanding and appreciation. Experiences in Folk, Square and Round dancing.

PE 38 - ADAPTIVE PHYSICAL EDUCATION 1 Unit

Prerequisites: None

3 hours activity weekly

A special course designed to meet the needs of students who are unable to participate in regular physical education activity classes. Students will be classified by the college physician as to the type of physical activity in which they may participate. Each student is given individual attention in terms of adapted and recreational activities suited to his/her needs. May be repeated for credit.

PE 39A - BEGINNING BALLET 1½ Units

Prerequisites: None

1 hour lecture, 2 hours activity weekly

An introduction to basic ballet techniques. Classes will include exercise at the barre to develop flexibility, strength, control, and resilience and center practice of simple Port des Bras. Adage and Allegro combinations.

PE 40 - BEGINNING VOLLEYBALL 1½ Units

Prerequisites: None

1 hour lecture, 2 hours activity weekly

Development of basic skills in playing volleyball including rules, techniques of playing power volleyball.

PE 41 - BEGINNING MODERN JAZZ 1½ Units

Prerequisites: None

1 hour lecture, 2 hours activity weekly

Development of proficiency in jazz technique and skills and development of an understanding and appreciation of jazz as a dance form.

PE 44 - JOGGING FOR FITNESS 1 Unit

Prerequisites: None

3 hours activity weekly

This course is designed to help the individual improve his physical health and general well being. The course is open to all students. Emphasis will be placed on endurance training with a gradual increase of running. Special attention will be given to cardiovascular fitness and weight control.

PE 45 - INTRODUCTION TO YOGA 1½ Units

Prerequisites: None

1 hour lecture, 2 hours activity weekly

Hatha Yoga, an eastern approach to physical well-being that includes relaxation techniques, specific therapy for body control, good health, and some techniques for mental and emotional control. Background of Hatha Yoga and diet will also be covered.

PE 47 - BEGINNING SKIING

½ Unit

Prerequisites: None

1 hour lecture, 2 hours activity weekly (9 weeks)

This course will cover the GLM dry land ski instruction. The course will also cover the purchasing, care and repair of ski equipment and clothing.

PE 49 - TAI CHI CHUAN

1 Unit

Prerequisites: None

3 hours activity weekly

Tai Chi Chuan is an ancient Chinese system of isometric dance forms consisting of 108 movements carried out in a slow, continuous, rhythmic sequence inducing health, relaxation, and peace of mind. Actual dynamic movements of Tai Chi Chuan will be learned and practiced.

intermediate activities

PE 50 - INTERMEDIATE BODY CONDITIONING (MEN)

1½ Units

Prerequisites: PE 1

1 hour lecture, 2 hours activity weekly

Advanced techniques and skills of the principles of fitness and the development and maintenance of a high level of efficiency.

PE 51 - INTERMEDIATE BADMINTON (CO-ED)

1½ Units

Prerequisites: PE 31 or Intermediate Skills Test

1 hour lecture, 2 hours activity weekly

Advanced techniques and strategies in badminton including participation in competitive tournaments and ladders.

PE 52 - INTERMEDIATE WRESTLING (MEN)

1½ Units

Prerequisites: PE 4

1 hour lecture, 2 hours activity weekly

A continuation of beginning wrestling (PE 4) which will include advanced techniques and take-downs, rides, escapes and falls. Advanced instruction given concerning pinning combinations and strategies, and tactics.

PE 53 - INTERMEDIATE GOLF (CO-ED)

2 Units

Prerequisites: PE 33 or consent of instructor

1 hour lecture, 3 hours activity weekly

Advanced techniques and skills development with special emphasis on links play. Students are assigned play on local courses at their own expense. NOTE: The evening sections of golf meet only 2 hours and receive ½ unit.

PE 54A - INTERMEDIATE TENNIS

2 Units

Prerequisites: PE 34 or a skills test by instructor

1 hour lecture, 3 hours activity weekly

Development of higher proficiency and performance of tennis skills with special emphasis on game strategy and techniques. (F)

PE 54B - ADVANCED TENNIS

2 Units

Prerequisites: Beginning and Intermediate tennis or consent of instructor
1 hour lecture, 3 hours activity weekly

Advanced techniques and theory of playing tennis - strategy of tournament playing. (S)

PE 55 - INTERMEDIATE BASEBALL

1½ Units

Prerequisites: None
1 hour lecture, 2 hours activity weekly

Fall class in which advanced techniques and strategies of baseball are developed. A high degree of skill is emphasized during actual games.

PE 56 - INTERMEDIATE MODERN DANCE

2 Units

Prerequisites: PE 36 or consent of instructor
1 hour lecture, 3 hours activity weekly

A continuing study of modern dance with technique emphasis upon combination of basic skills. Study of the dance phrase with integration of the elements of rhythm, design, dynamics, and motivation change.

PE 57 - INTERMEDIATE BASKETBALL (MEN)

1½ Units

Prerequisites: Basketball experience - understanding of rules
1 hour lecture, 2 hours activity weekly

Advanced techniques and strategies in basketball. A continuing development of a high degree of skill is emphasized.

PE 58 - INTERMEDIATE FOOTBALL

1½ Units

Prerequisites: Advanced football ability
1 hour lecture, 2 hours activity weekly

Development of advanced skills in football and the theory behind the different styles of play.

PE 59 - INTERMEDIATE TRACK (CO-ED)

1½ Units

Prerequisites: Consent of instructor
1 hour lecture, 2 hours activity weekly

Advanced technique and strategies in track and field. A continuing development of a high degree of skill is emphasized in the preparation for a competitive season. Special attention will be given to the research of the skills needed for the proficiency in the sport. This is a requirement for varsity track candidates.

PE 60 - INTERMEDIATE VOLLEYBALL

1½ Units

Prerequisites: Playing ability in volleyball
1 hour lecture, 2 hours activity weekly

Advanced techniques and strategies in playing power volleyball at the six, four and two man levels. A continuing development of high level skills is emphasized.

PE 61 - INTERMEDIATE CO-ED GYMNASTICS

1½ Units

Prerequisites: Men - PE 24A/B; Women - PE 11A/B
1 hour lecture, 2 hours activity weekly

Development of fundamental skills in tumbling, free exercise and apparatus for those already trained in the elementary gymnastic skills.

PE 62 - INTERMEDIATE KARATE **1½ Units**
Prerequisites: PE 28 - Introduction to Karate
1 hour lecture, 2 hours activity weekly

Development of skill in the advanced fundamentals and techniques of Karate.

PE 63 - INTERMEDIATE SOCCER **1½ Units**
Prerequisites: PE 7
1 hour lecture, 2 hours activity weekly

Advanced techniques and skills in the game of soccer.

PE 64 - INTERMEDIATE JOGGING **1 Unit**
Prerequisites: PE 44
3 hours activity weekly

This course will develop one's cardiovascular system and take a closer examination of training methods.

PE 66 - INTERMEDIATE RUGBY **1½ Units**
Prerequisites: PE 6
1 hour lecture, 2 hours activity weekly

Advanced development of the skills in playing rugby. The course covers advanced skills in passing, kicking, and offensive and defensive strategy.

PE 67 - INTERMEDIATE ARCHERY **1½ Units**
Prerequisites: PE 30 or consent of instructor
1 hour lecture, 2 hours activity weekly

A continuing study of archery with technique emphasis upon advanced skills.

PE 68 - INTERMEDIATE BOWLING **1 Unit**
Prerequisites: PE 32
3 hours activity weekly

Advanced techniques and strategies in bowling and participation in competitive events.

PE 69 - INTERMEDIATE JUDO **1½ Units**
Prerequisites: PE 29
1 hour lecture, 2 hours activity weekly

Development of skill in the advanced fundamentals and techniques of Judo.

PE 70 - VARSITY BASEBALL (MEN) **3 Units**
Prerequisites. Meet the requirements for athletic eligibility in the Western State Conference and/or coach's permission.
1 hour lecture, 9 hours activity weekly

Varsity sports are highly competitive and require an advanced degree of skill. Students engaged in varsity sports should expect to compete against other institutions, travel, and put in additional hours beyond the normal activity load. Varsity sports meet the P.E. activity requirement.
Equivalent to PE 215, CSUN



PE 71 - VARSITY BASKETBALL

3 Units

Prerequisites: Meet the requirements for athletic eligibility in the Western State Conference
1 hour lecture, 9 hours activity weekly

Varsity sport highly competitive and requiring advance degree of skill. Students engaged in varsity sports should expect to compete against other institutions, travel, and put in additional hours beyond the normal activity load. Varsity sports meet the P.E. activity requirement.
Equivalent to PE 201, CSUN

PE 72 - VARSITY CROSS COUNTRY

3 Units

Prerequisites: Permission of instructor
1 hour lecture, 9 hours activity weekly

Varsity sports are highly competitive and require an advanced degree of skill. Students engaged in varsity sports should expect to compete against other institutions, travel, and put in additional hours beyond the normal activity load. Varsity sports meet the P.E. activity requirement.
Equivalent to PE 203, CSUN

PE 73 - INTERCOLLEGIATE FOOTBALL

3 Units

Prerequisites: Meet requirements for athletic eligibility in Western State Conference
1 hour lecture, 9 hours activity weekly

Varsity sport highly competitive and requiring high degree of skill. Students engaged in varsity sports should expect to compete against other institutions, travel, and put in additional hours beyond the normal activity load. Varsity sports meet the P.E. activity requirement.
Equivalent to PE 200, CSUN

PE 74 - VARSITY GOLF (MEN)

3 Units

Prerequisites: Meet the requirements for athletic eligibility in the Western State Conference and/or coach's permission.
1 hour lecture, 9 hours activity weekly

Varsity sports are highly competitive and require an advanced degree of skill. Students engaged in varsity sports should expect to compete against other institutions, travel, and put in additional hours beyond the normal activity load. Varsity sports meet the P.E. activity requirement.
Equivalent to PE 210, CSUN

PE 75 - VARSITY TENNIS

3 Units

Prerequisites: Meet the requirements for athletic eligibility in the Western State Conference and/or coach's permission.
1 hour lecture, 9 hours activity weekly

Varsity sports are highly competitive and require an advanced degree of skill. Students engaged in varsity sports should expect to compete against other institutions, travel, and put in additional hours beyond the normal activity load. Varsity sports meet the P.E. activity requirement.
Equivalent to PE 211, CSUN

PE 76 - VARSITY TRACK

3 Units

Prerequisites: Successful completion of PE 59 and meet Western State Conference eligibility requirements.
1 hour lecture, 9 hours activity weekly

Varsity sports are highly competitive and require an advanced degree of skill. Students engaged in varsity sports should expect to compete against other institutions, travel, and put in additional hours beyond the normal activity load. Varsity sports meet the P.E. activity requirement.
Equivalent to PE 214, CSUN

PE 77 - VARSITY WRESTLING

3 Units

Prerequisites: Meet requirements for athletic eligibility in the Western State Conference.
1 hour lecture, 9 hours activity weekly.

Varsity sports are highly competitive and require an advanced degree of skill. Students engaged in varsity sports should expect to compete against other institutions, travel, and put in additional hours beyond the normal activity load. Varsity sports meet the P.E. activity requirement.
Equivalent to PE 204, CSUN

professional courses

PE 80 - MEN'S PROFESSIONAL ACTIVITIES I

2 Units

Prerequisites: Consent of instructor and/or enrolled in P.E. major/minor program
1 hour lecture, 4 hours laboratory weekly.

Development of skills, safety habits, appreciation and knowledge of rules, strategy, and background of the following activities: rugby, soccer, speedball, trampoline, tumbling.
Equivalent to PE 180, CSUN
Accepted for credit, UC (all branches)

PE 81 - WOMEN'S PROFESSIONAL ACTIVITIES I

2 Units

Prerequisites: Consent of instructor and/or enrolled in P.E. major/minor program
1 hour lecture, 4 hours laboratory weekly

An orientation to the field of physical education and development of skills, safety habits, appreciation and knowledge of rules, strategy, and background of the following activities: body mechanics, calisthenics and gymnastics, trampoline and tumbling.
Equivalent to PE 181, CSUN
Accepted for credit, UC (all branches)

PE 84 - MEN'S PROFESSIONAL ACTIVITIES III

2 Units

Prerequisites: Consent of instructor and/or enrolled in P.E. major/
minor program

1 hour lecture, 4 hours laboratory weekly

Development of skills, safety habits, appreciation and knowledge of rules, strategy and background of the following activities: archery, badminton, basketball, golf, lead-up games, volleyball.

Equivalent to PE 280, CSUN

Accepted for credit, UC (all branches)

PE 85 - WOMEN'S PROFESSIONAL ACTIVITIES III

2 Units

Prerequisites: Consent of instructor and/or enrolled in P.E. major/
minor program

1 hour lecture, 4 hours laboratory weekly

An orientation to the field of dance in physical education and development in skills, appreciation and knowledge of modern dance and basic dance forms including background information. (F)

Accepted for credit, CSUN

Accepted for credit, UC (all branches)

PE 86 - MEN'S PROFESSIONAL ACTIVITIES IV

2 Units

Prerequisites: Consent of instructor and/or enrolled in P.E. major/
minor program

1 hour lecture, 4 hours laboratory weekly

Development of skills, safety habits, appreciation and knowledge of rules, strategy, and background of the following activities: baseball, football, softball, tennis, track and field.

Equivalent to PE 281, CSUN

Accepted for credit, UC (all branches)

PE 82 - MEN'S PROFESSIONAL ACTIVITIES II

2 Units

Prerequisites: Consent of instructor and/or enrolled in P.E. major/
minor program.

1 hour lecture, 4 hours laboratory weekly.

Development of skills, safety habits, appreciation and knowledge of rules, strategy, and background of the following activities: Gymnastics, handball, weight training, wrestling.

Equivalent to PE 181, CSUN

Accepted for credit, UC (all branches)

PE 83 - WOMEN'S PROFESSIONAL ACTIVITIES II

2 Units

Prerequisites: Consent of instructor and/or enrolled in P.E. major/
minor program.

1 hour lecture, 4 hours laboratory weekly

Development of skills, safety habits, appreciation and knowledge of rules, strategy and background of the following activities: Marching, tennis, badminton, archery and track and field.

Accepted for credit, CSUN

Accepted for credit, UC (all branches)

PE 87 - WOMEN'S PROFESSIONAL ACTIVITIES IV

2 Units

Prerequisites: Consent of instructor and/or enrolled in P.E. major/
minor program

1 hour lecture, 4 hours laboratory weekly

Orientation to field of physical education and development of skills, safety habits, appreciation and knowledge of rules, strategy, and background of the following activities: volleyball, softball, soccer and field hockey.

Accepted for credit, CSUN

Accepted for credit, UC (all branches)

PE 89A/B - DANCE PRODUCTION (CO-ED)

1-2 Units

Prerequisites: Beginning and Intermediate Modern Dance and/or
consent of instructor.

1 hour lecture, 1-3 hours laboratory weekly

Practical experience in the many phases of dance concert and demonstration, i.e., choreography, staging, make-up, costumizing, set designing and construction, lighting, and publicity.

Accepted for credit, UC (all branches)

PE 90 - INTRODUCTION TO PHYSICAL EDUCATION (CO-ED)

2 Units

Prerequisites: None

2 hours lecture weekly

A general survey of the field of Physical Education; exploration of the aims, objectives, scope and contemporary values of Physical Education, project and field work required. (F)

Accepted for credit, UC (all branches)

PE 91A/B - SPORTS OFFICIATING (MEN)

2½-2½ Units

Prerequisites: None

2 hours lecture, 1 hour laboratory weekly

Instruction and laboratory experience in sports officiating for men. Proficiency ratings required to successfully complete the course PE 91A during the fall semester - football, basketball, soccer, wrestling, PE 91B during the spring semester - track, baseball, rugby, volleyball.

Accepted for credit, UC (all branches)

PE 93A/B - WOMEN'S SPORTS OFFICIATING

2½-2½ Units

Prerequisites: Consent of instructor and enrolled in P.E. major/minor
program

2 hours lecture, 3 hours laboratory weekly

Instruction and laboratory experience in sports officiating for women.

93A - Fall semester - Individual sports

93B - Fall semester - Team Sports.

Offered alternate fall semesters.

Equivalent to PE 288 and 289, CSUN

Accepted for credit, UC (all branches)

PE 94 - BASKETBALL THEORY

2 Units

Prerequisites: Advanced basketball ability
1 hour lecture, 3 hours activity weekly

Development of advanced skills in basketball and the theory behind different styles of play. Including studying of films, drills, rules and techniques of coaching.

PE 95 - FOOTBALL THEORY

2 Units

Prerequisites: Advanced football ability
1 hour lecture, 3 hours activity weekly.

Development of advanced skills in football and the theory behind the different styles of play, including studies of films, drills, rules and techniques of coaching.

PE 96 - BASEBALL THEORY

2 Units

Prerequisites: Advanced baseball ability
1 hour lecture, 3 hours activity weekly

Development of advanced skills in baseball and the theory behind the methods and styles of play. Class members will participate in summer baseball program with lab assignments and will have weekly lectures including films and guest lecturer to facilitate instruction.

PE 97 - CREATIVE MOVEMENT ACTIVITIES FOR CHILDREN

3 Units

Prerequisites: None
2 hours lecture, 3 hours activity weekly

A presentation of methods and materials which parents and teachers of pre-school and early elementary-aged children can utilize in encouraging and directing creative movement experiences, in the school, home, or various organizations.

Accepted for credit, UC (all branches)



physics

Faculty: John Menzie, H. Fred Meyer

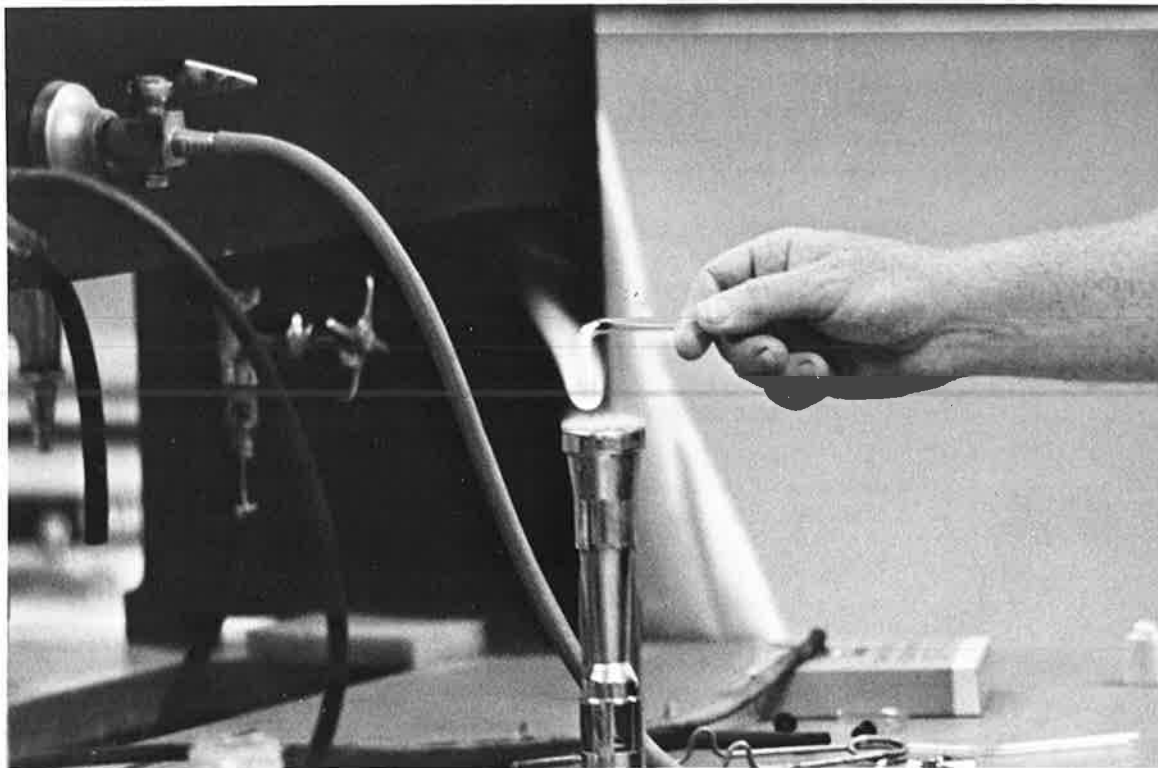

Physicists investigate and attempt to understand the fundamental laws of nature and how these laws may be formulated and put to use. The physics major is designed for students interested in gaining an understanding of these fundamental laws of nature, learning the arts of experimentation, and applying this knowledge and art to a wide range of careers. Since the knowledge of physics, and the experimental arts form a foundation for all of science and engineering, physicists have excellent opportunities in government and industry - from soil mechanics to space physics - from biophysics to the theoretical work of a high energy elementary particle physicist. There is great need in high schools, colleges and universities for teachers and research physicists.

REQUIRED COURSES IN MAJOR

California State University, Northridge

Ph 4	Mechanics of Solids and Fluids
Ph 5	Electricity and Magnetism
Ph 6	Heat, Sound, Optics & Modern Physics
Math 25A/B/C	Calculus with Analytic Geo.
Math 35	Applied Dif. Equations

University of California, Los Angeles

Ph 4	Mechanics of Solids and Fluids
Ph 5	Electricity and Magnetism
Ph 6	Heat, Sound, Optics & Modern Physics
Math 25A/B/C	Calculus with Analytic Geo.
Math 35	Applied Dif. Equations

courses in physics

Ph 2A/B - GENERAL PHYSICS

4-4 Units

Prerequisites: High School mathematics through trigonometry or Math 7
(may be taken concurrently); Ph 2A for Ph 2B
3 hours lecture and 3 hours laboratory weekly

First semester—An introduction to mechanics, heat, sound and optics. A descriptive course with some quantitative work. Demonstration lectures and solution of problems. A course designed to meet the needs of medical, dental optometry, and liberal arts students. The role of the laboratory is defined and basic arts of planning, execution, analysis and synthesis in experimentation is practiced. (F)

Equivalent to Physics 100A, CSUN

Second semester—An introduction to electricity, atomic, nuclear and relativistic physics. Demonstrations, lectures, assignment of problems, and laboratory experiments. A continuation of Ph 2A (S)

Equivalent to Physics 100B, CSUN

Phys 2A-2B accepted for credit, UC (all branches)

Ph 3 - THE ARTS OF EXPERIMENTAL INVESTIGATION

1 Unit

Corequisite: Concurrent enrollment in Ph 10
3 hours laboratory weekly.

A laboratory course to accompany Physics 10. The role of the laboratory in solving problems is defined and basic arts of planning, execution, analysis and synthesis in experimentation is practiced. Basic measurement skills of time, mass, lengths and charge are required. (F,S)

Accepted for credit, UC (all branches)

Ph 4 - MECHANICS OF SOLIDS AND FLUIDS

5 Units

Prerequisites: Math 25A; corequisite; Math 25B, high school
Physics or equivalent, or written consent of
instructor
4 hours lecture, 3 hours laboratory weekly

An introductory study of statics and dynamics of particle, rigid bodies, plus an introduction to hydrostatics and hydrodynamics. This course uses calculus and vector analysis and is intended for majors in physics, engineering, chemistry, or mathematics.

Ph 5 - ELECTRICITY AND MAGNETISM

5 Units

Prerequisites: Physics 4, Math 25B; corequisite, Math 25C
4 hours lecture, 3 hours laboratory weekly

An introduction to electricity and magnetism. Emphasis is placed on understanding of field theory and applications of calculus. Topics include: gravitational, electric and magnetic field; Coulomb's Law; Gauss' Law; Faraday's Law; Amperes Law; Biot-Savart Law; Ohms Law; A.C. and D.C. circuits; and introductory electronics.

Ph 6 - HEAT, SOUND, OPTICS AND MODERN PHYSICS**5 Units**

Prerequisites: Physics 4 and 5; Mathematics 25A/B/C. It is suggested that Differential Equations be taken concurrently.

4 hours lecture, 3 hours laboratory weekly

An introduction to geometrical optics, wave motion (sound and light), physical optics, thermodynamics. Selected topics in quantum mechanics and special relativity are discussed at an elementary level. The solution of problems in vector calculus and differential equations is demonstrated.

Combination of Physics 4, 5, and 6 is equivalent to Physics 220 A, B, C, CSUN

Ph 4B - MECHANICS OF FLUIDS, HEAT AND SOUND**3 Units**

Prerequisites: Successful completion of Ph 4A or equivalent. Math 25B must be taken concurrently or have been completed.

2 hours lecture, 3 hours laboratory weekly.

An introduction to hydrostatics, hydrodynamics, thermodynamics processes and systems, mechanical waves. Some basic exercises in lab and some real problems. (S)

Ph 4D - OPTICS AND MODERN PHYSICS**3 Units**

Prerequisites: Successful completion of Ph 4C, its equivalent or permission of instructor and successful completion of Math 25C.

2 hours lecture, 3 hours laboratory weekly.

An introduction to geometrical and physical optics, atomic and nuclear physics. Selected topics in quantum mechanics are discussed at elementary level. The solution of problems in vector calculus and differential equations is demonstrated. Three hours of laboratory work each week in optics, atomic and nuclear physics. Some neutron activation analysis.

Accepted for credit UC (all branches)

Physics 4B and 4D will be offered in the Fall of 1973 only. Those students finishing Physics 4B will continue the sequence by taking Physics 5 and 6.

Ph 10 - DESCRIPTIVE PHYSICS**3 Units**

Prerequisite: Math 1 or equivalent

3 hours lecture weekly (3 hours lab recommended, but not required)

Primarily a non-mathematical description of the basic principles of physics, using discussions, lecture-demonstrations, oral and written reports.

With Ph 3, equivalent to Ph 160, CSUN

Accepted for credit, UC (all branches)

Ph 11A/B - TECHNICAL PHYSICS**4-4 Units**

Prerequisites: High School algebra with grade of C or higher or Math 3.

3 hours lecture, 3 hours laboratory weekly.

Mechanics, heat, electricity, magnetism, sound, light and atomic energy with emphasis on technical applications in industry. A rigorous but non-calculus course in basic applied physics. Required of all technical majors. (F)

Ph 12A - APPLIED PHYSICS**1 Unit**

Prerequisites: Consent of instructor and/or high school algebra
16 hours lecture for 1 unit

A description of the basic principles of physics and science. The emphasis will be on the study of mechanics to include motion, forces, work and energy. The principle mode of learning will be lecture-demonstrations, discussions, problem solving and simple directed experiments.

Accepted for credit, CSUN

Ph 12B - APPLIED PHYSICS**1 Unit**

Prerequisites: Physics 12A or consent of instructor
16 hours lecture for 1 unit

A description of the basic principles of physics. The emphasis will be on properties of materials, temperature, heat and optics. The principle modes of learning will be lecture-demonstrations, discussions, problem solving and simple directed experiments.

Accepted for credit, CSUN

Ph 12C - APPLIED PHYSICS**1 Unit**

Prerequisites: 12A, 12B or consent of instructor
16 hours lecture for 1 unit

A description of the basic principles of physics. The emphasis will be upon electricity and magnetism. The principles modes of learning will be lecture-demonstration, problem solving and simple directed experiments.

Accepted for credit, CSUN

Ph 22A/B - DIRECTED STUDIES IN PHYSICS**1-3/1-3 Units**

Prerequisites: A course in the specific field with a recommending grade
and consent of instructor and Division Chairman.
1-3 hours tutorial weekly.

Designed for selected students who are interested in furthering their knowledge of physics on an independent study basis. Assigned problems will involve library, laboratory, and field work. (F,S)

Maximum of 3 units accepted for credit, CSUN

physical science

Phys Sci 1 - INTRODUCTION TO PHYSICAL SCIENCE**3 Units**

Prerequisite: Math 1 or equivalent recommended.
2 hours lecture, 3 hours laboratory weekly

Experimental approach to the nature of the physical world, emphasizing the basic principles of Chemistry and Physics and the ways in which these principles affect matter. Representative topics to be investigated include properties of matter, mixtures and their separations, radioactivity, atomic and molecular theories, and energy.

Equivalent to Physical Science 150, CSUN
Accepted for credit, UC (all branches)

Phys Sci 5 - INTRODUCTION TO METEOROLOGY

3 Units

Prerequisite: None
3 hours lecture weekly

Introduction to meteorological phenomena; energy, atmospheric circulation, precipitation, storms. Interrelationships between land, sea and atmosphere. Introduction to meteorological instrumentation and reporting. Interpretation of data. Introduction to Aviation Weathers, Weather Modification. (Co-number Geog. 5)

Phy Sci 5L - INTRODUCTION TO METEOROLOGY LABORATORY

1 Unit

Prerequisites: Phy Sci 5/Geog 5 concurrent or consent of instructor
3 hours laboratory weekly

Laboratory to accompany Phys Sci 5. Introduction to Meteorological observation; cloud identification, instrumentation; interpretation of weather charts and data; weather system identification and analysis. Field trips required. (Co-number Geog 5L)

Phys Sci 10 - SKY AND TELESCOPE

2 Units

Prerequisites: None
2 hours lecture weekly

A general interest-education course that will survey some major consideration in intergalactic space such as birth and death of stars, dimensions of the Universe and the destiny of the Universe. Field trips, evening star studies and contemporary literature will provide background for the in-class discussions.
Accepted for credit, UC (all branches)

Phys Sci 22A/B - DIRECTED STUDIES IN PHYSICAL SCIENCE

1-3/1-3 Units

Prerequisites: A course in the specific field and consent of instructor and Division Chairman
1-3 hours tutorial weekly

Designed for selected students who are interested in furthering their knowledge of physical science on an independent study basis. Assigned problems will involve library, laboratory, and field work. Maximum of 6 units.
Maximum of 3 units accepted for credit, CSUN

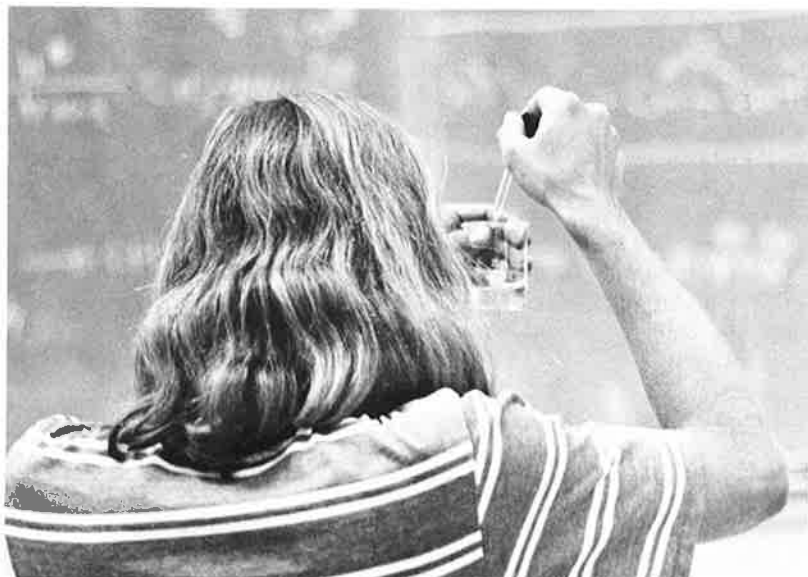

political science

Faculty: William Bendat, Gerald Bridgeman, Robert Herman,
Stephen Herzog, Richard Perry

Political Science is the study of government. Political scientists are interested in government at every level—local, county, state, regional, national and international. Political scientists are employed in colleges, in such federal agencies as the U.S. Department of State and the U.S. Information Agency, and at the city, county, and state levels of government. They make studies of legislation and analyze the operations of government and of non-government organizations that affect legislation.

REQUIRED COURSES IN THE MAJOR

California State University, Northridge

Pol Sci 1	Intro to Government
Pol Sci 2	Comparative Government
Pol Sci 3	American Government
Econ 1A	Principles of Economics
Hist 1B	Intro to West. Civilization

University of California, Santa Barbara

Pol Sci 1	Intro to Government
Pol Sci 2	Comparative Government
Pol Sci 3	American Government

Five courses from the following areas:

Anth 2	Cultural Anthropology
Econ 1A or 1B	Principles of Economics
Hist 1A/1B	Intro to Western Civ.
Hist 7A/7B	Soc/Political Hist. of U.S.
Hist 15A/15B	Intro to History of Asia
Psych 2	General Psychology
Soc 1	Intro to Sociology
Soc 2	Social Problems

courses in political science

Pol Sci 1 - INTRODUCTION TO GOVERNMENT

3 Units

Prerequisite: Satisfactory score on Placement Test.
3 hours lecture weekly.

Basic principles of political science as it applies to government, and processes of politics; fulfills state requirements for federal state and local government. The student will do research and writing on special topics, and the case study of selected political problems will be used to supplement the lectures and discussions. For social science majors or others with strong interest in this area. Course fulfills state requirements for American Institutions.

Accepted for credit, CSUN

Accepted for credit, UC (all branches)

Pol Sci 2 - COMPARATIVE GOVERNMENT

3 Units

Prerequisite: Satisfactory score on Placement Test.
3 hours lecture weekly.

A comparative study of selected government of the Americas, Europe, Africa and Asia, including the United States, Britain, France, Germany, the Soviet Union, China, and India. Fulfills the state requirements for study of American Institutions.

(F)

Equivalent to Poli Sci 156, CSUN

Accepted for credit, UC (all branches)

Pol Sci 3 - AMERICAN GOVERNMENT**3 Units**

Prerequisite: Satisfactory score on Placement Test.
3 hours lecture weekly.

Survey of the main characteristics, historical background, contemporary principles, structure, practice and issues of American government, including the national, California state and local government; fulfills the state requirement for study of American Institutions. The emphasis will be placed on field research in practical politics. (F,S)

Equivalent to Poli Sci 155, CSUN
Accepted for credit, UC (all branches)

Pol Sci 4 - INTERNATIONAL RELATIONS**3 Units**

Prerequisites: Satisfactory score on Placement Test
3 hours lecture weekly.

The course is a study of relations between sovereign units. It will concentrate on international organization, theoretical proposals toward and possibilities for world peace, the simple mechanics of politics among nations, and will consider the formation of American foreign policy. Attention will be paid to the relationship between domestic and foreign politics.

Accepted for credit, UC (all branches)
Accepted for credit, CSUN

Pol Sci 7 - MINORITY GROUPS**3 Units**

Prerequisites: None.
3 hours lecture weekly.

A study of the historical and contemporary political problems faced by religious, ethnic, sexual, low income, and racial minorities in America. The course is intended to study the environment America creates for the minority group member, the prejudice he faces, and the means he finds for overcoming the prejudice and becoming an equal participant in the political process. The political process is seen as an area in which majority-minority relations are studied and where negotiations and compromises are achieved in solving minority group problems. Fulfills the state requirement for study of American Institutions.

Equivalent to Political Science 196, CSUN
Accepted for credit, UC (all branches)

Pol Sci 8 - POLITICAL PATTERNS IN THE U. S.**3 Units**

Prerequisites: Satisfactory score on Placement Test.
3 hours lecture weekly.

An analysis of the political participation of La Raza in the United States. Special attention will be focused on the political responses of Chicanos, Puerto Ricans and Native American Indians to their subordinate position in the United States. Course fulfills the state requirements for study of American Institutions. (Co-number MAS 8)

Accepted for credit, UC (all branches)

Pol Sci 9 - ADJUDICATION OF SOCIAL ISSUES**3 Units**

Prerequisites: Satisfactory score on Placement Test
3 hours lecture weekly

This course explores current social issues from a legal point of view. Such topics as abortion, drugs, free speech and press, obscenity, draft resistance, and consumers' and debtors' rights are studied using the case method approach. Fulfills the state requirements for study of American Institutions.

Baccalaureate Level

PoI Sci 10 - PUBLIC ADMINISTRATION AND POLICY DEVELOPMENT 3 Units

Prerequisites: Satisfactory score on Placement Test.
3 hours lecture weekly.

This course will focus upon the role of administration in government with special emphasis on the potentially commanding position of bureaucratic power in American politics. The course is designed to help the student develop an understanding of what public administration is, how decisions are made in the public bureaucracy, what its tasks are, and how it goes about accomplishing these tasks. Fulfills the state requirements for study of American Institutions.

Accepted for credit, UC (all branches)

Accepted for credit, CSUN

PoI Sci 22A/B - DIRECTED STUDIES IN POLITICAL SCIENCE 1-3/1-3 Units

Prerequisites: A course in the specific field with a recommending grade and consent of instructor and Division Chairman.

1-3 hours tutorial weekly.

Designed for selected students who are interested in furthering their knowledge of political science on an independent study basis. Assigned problems will involve library and field work.

3 units maximum credit, CSUN

For information regarding Work Experience credit in the Political Science program, refer to Page 224 in this catalog.

Faculty: Alan Lowe, Darlene Pacheco, Steven J. Pollock, Maxine Tallman

psychology

Psychologists study the behavior of individuals and groups and may be found in many areas of our contemporary society. Some of the more common positions in the field of Psychology are teaching and research in colleges and universities, counseling, and working with maladjusted people in a clinical setting. Other fields of Psychology include developmental, industrial, experimental, personnel and human engineering. A Bachelor's degree in Psychology will satisfy the requirement for an academic major in obtaining a teaching credential, both for the elementary and secondary credentials.

REQUIRED COURSES IN THE MAJOR

California State University, Northridge

Psych 1A Intro to Psychology
Psych 1B Intro to Experimental Psych
Math 15 Introductory Statistics

University of California, Santa Barbara

Psych 1A Intro to Psychology
Psych 1B Intro to Experimental Psych
Math 15 Introductory Statistics
Biol 2A General Biology
or
Biol 1 Principles of Biology
Chem 1A General Chemistry
Ph 2A General Physics
or
Ph 10 Descriptive Physics
Math 14 Finite Mathematics
or
Math 25A Calculus w/Analytic Geom I

courses in psychology

Psych 1A - INTRODUCTION TO PSYCHOLOGY

3 Units

Prerequisites: Satisfactory score on Placement Test
3 hours lecture weekly

An introduction to the subject matter of psychology with emphasis on scientific method, growth and development, sensation and perception, motivation and emotion, learning and cognition, personality, mental health. Designed particularly for psychology majors. Designed for the needs of students majoring in Anthropology, Biology, medicine, Psychology and Sociology. A student should not take both Psych 1A and Psych 2.
Equivalent to Psych 150, CSUN
Accepted for credit, UC (all branches)

Psych 1B - INTRODUCTION TO EXPERIMENTAL PSYCHOLOGY

4 Units

Prerequisites: Psych 1A or Psych 2
4 hours lecture weekly

An introduction to experimental methodology in psychology with an emphasis on the scientific method, basic statistics and the physiological bases of behavior. Individual experimental study is included. Recommended as a second course in the major sequence.

Equivalent to Psych 250, CSUN
Accepted for credit, UC (all branches)

Psych 2 - GENERAL PSYCHOLOGY

3 Units

Prerequisites: Satisfactory score on Placement Test
3 hours lecture weekly

A survey of the subject matter of psychology. Subject areas will include philosophy of science, heredity, and environment, growth and development, motivation, emotion, learning, personality, and mental health. Designed for those not majoring in psychology. Students preparing for elementary, secondary or community college teaching credentials should take this course. Designed for the needs of students majoring in dentistry, nursing, political science. No student should take both Psych 1A and Psych 2.

Accepted for credit, CSUN
Accepted for credit, UC (all branches)

Psych 3 - PERSONAL & SOCIAL ADJUSTMENT

3 Units

Prerequisites: Satisfactory score on Placement Test
3 hours lecture weekly

Orientation in the use of psychological principles applied in understanding human relationships and developing social adaptability. Emphasis will be on the nature of man, human needs and goals, the processes of personal and social adjustment, and mental health.

Accepted for credit, CSUN
Accepted for credit, UC (all branches)

Psych 4 - CHILD PSYCHOLOGY

3 Units

Prerequisites: One course in the field of Psychology or consent of instructor

3 hours lecture weekly

The focus of this course will be on the psychology of children as well as on basic principles of developmental psychology. While the major emphasis will be on the child as a person, exploration of the personal, societal, and cultural forces important from birth to puberty will be made.

Accepted for credit, CSUN

Psych 5 - SOCIAL PSYCHOLOGY

3 Units

Prerequisites: One course in the field of Psychology

3 hours lecture weekly

A study of human social relationships. Topics of study include personal interaction, structure and leadership, role and status, fads and fashions, attitude formation and change, communication and propaganda, nature of prejudice and social change. Stress is placed upon methods of easing group tensions and solving current problems.

Baccalaureate Level

Psych 6 - THE PSYCHOLOGY OF WOMEN

3 Units

Prerequisites: One course in Psychology

3 hours lecture weekly

This course explores the psychological, physiological, and sociological determinants of female psychology. Included in this exploration are such topics as sex role development, role conflicts, common stereotypes of women, women as a minority group, female sexuality, and the psychological implications of the women's liberation movement.

Baccalaureate Level

Psych 12 - BEHAVIORAL PRINCIPLES

3 Units

Prerequisites: Consent of instructor

3 hours lecture weekly

An introduction to behavioral theory in learning principles. Consideration will be given to experimental analysis of behavior, antecedent, and consequences, as well as a demonstration of ability to alter behavior using contingencies of reinforcement and stimulus control. Emphasis will be on class discussion and peer learning as well as select case studies.

Psych 13 - BEHAVIORAL TECHNIQUES

3 Units

Prerequisites: Psych 12 and consent of instructor

3 hours lecture weekly

This course will examine counter-conditioning theory and practice, including the formulation of a counter conditioning therapy program which will be implemented with a selected subject. Emphasis will be on developing a competence in utilizing counter-conditioning techniques.

Psych 14 - CONTINGENCE MANAGEMENT**3 Units**

Prerequisites: Psych 13 and consent of instructor
3 hours lecture weekly

A review of contingencies of reinforcement as they apply to educational and mental health settings. Laboratory assignments will focus on the application of contingencies of reinforcements involving the effect of behavioral consequences, transfer from continuous interval schedules of reinforcement and behavioral self-control experiments.

Psych 15 - APPLIED BEHAVIOR FOR PARENTS**3 Units**

Prerequisites: Psych 14 and consent of instructor
3 hours lecture weekly

A review of the basic principles of human behavior, especially as applied to child management and child development. Attention will be given to the use of behavior modification methods in improving children's behavior.

Psych 22A/B - DIRECTED STUDIES IN PSYCHOLOGY**1-3/1-3 Units**

Prerequisites: A course in the specific field and consent of instructor
and Division Chairman

1-3 hours tutorial weekly

Designed for selected students who are interested in furthering their knowledge of psychology on an independent study basis. Assigned problems will involve library, laboratory, and field work. Maximum of 6 units.
3 unit maximum accepted, CSUN

reading

Faculty: Michael Strumpf, Sinclair Wall

Read 1A - BASIC READING SKILLS**3 Units**

Prerequisites: English placement test score and counselor recommendation.
2 hours lecture, 3 hours laboratory weekly.

Diagnosis of individual reading difficulties; adaption to assist student to overcome his individual difficulties providing suitable materials; use of reading accelerators.

Read 1B - ADVANCED LAB**2 Units**

Prerequisite: Read 1A
5 hours laboratory weekly

Improvement of skills in reading and studying that were taught in Read 1A. This course is entirely laboratory, with emphasis on using machines and kits available in the Reading Lab.

Read 2 - WORD POWER**3 Units**

Prerequisites: None

3 hours lecture, 2 hours laboratory weekly

The student will receive special training in the basic principles of word analysis: Latin and Greek roots, prefixes and suffixes, synonyms and antonyms, context clues. Special attention given to history and origin of words, focus on connotative and denotative word meanings with emphasis on propaganda techniques. A multi-media learning approach will be used.

Read 4A - TECHNIQUES OF READING**3 Units**Prerequisites: Satisfactory reading test score or instructor recommendation
2 hours lecture, 3 hours laboratory weekly.

Improvement of vocabulary and rate of comprehension, including skimming and scanning skills; use of mechanical aides; emphasis on college-level reading materials with focus on reading for significant details, main ideas, following printed directions, locating specific information, understanding figurative language, and inferring author's mood, tone, purpose, giving reasons for reading in the future. Accepted for credit, CSUN

Read 4B - ADVANCED READING LAB**2 Units**

Prerequisite: Read 4A

5 hours laboratory weekly.

Improvement of skills in reading and studying that were taught in Read 4A. The course is entirely laboratory, with emphasis on using machines and kits available in the Reading Lab.

Read 22A/B - DIRECTED STUDIES IN READING**1-3 Units**Prerequisites: A course in the specific field and the consent of the instructor
and Division Chairman

1-3 hours tutorial weekly.

Designed for selected students who are interested in furthering their knowledge or reading on an independent study basis. Assigned problems will involve library, laboratory, and field work. Maximum of 6 units.

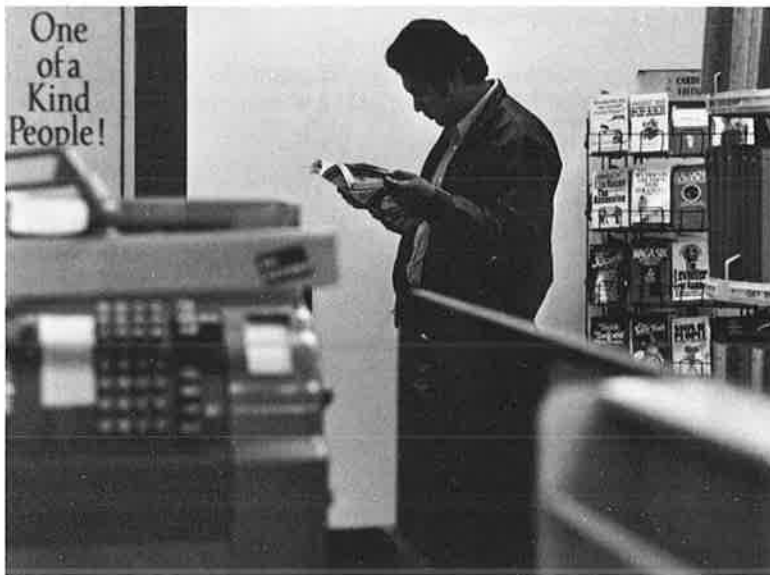



Faculty: Wm. C. Rodgers, Coordinator

real estate

The projected growth in the areas surrounding Moorpark College will create a demand for homes, schools, churches, shopping centers, and industrial developments. Professionally trained people in real estate will provide much of the leadership in fields of residential and industrial brokerage, property management, research and land development.

REQUIRED COURSES IN THE MAJOR

RE 91*	Real Estate Principles
RE 92*	Legal Aspects of Real Estate
RE 93*	Real Estate Practice
RE 94A*	Real Estate Appraisal I
RE 95+	Real Estate Finance
RE 96+	Real Estate Economics
Bus 3	Applied Accounting
Bus 30	Introduction to Business
Bus 35	Salesmanship
Bus 32	Small Business Management
Hum 1A/B	Man in Society

*A student employed in the field may receive an In-service Certificate in REAL ESTATE upon successful completion of the courses marked * and 6 additional units in General Education, for a total of 21 units.

+A student not currently employed in the field may receive a Pre-service Certificate in REAL ESTATE upon successful completion of the courses marked * plus the courses marked + and 9 additional units in General Education, including 6 units of Hum 1A or Hum 1B, for a total of 30 units.

courses in real estate

RE 91 - REAL ESTATE PRINCIPLES

3 Units

Prerequisites: None
3 hours lecture weekly.

Practical study of California real estate law to assist real estate salesman and real estate brokers designed to provide the necessary knowledge required of candidates for the California Real Estate Salesman's Examination. (F, S)

RE 92 - LEGAL ASPECTS OF REAL ESTATE

3 Units

Prerequisite: RE 91 or equivalent*
3 hours lecture weekly.

Practical study of California real estate law to assist real estate salesmen and brokers in avoiding the legal problems which arise in conjunction with real estate transactions; case study methods are utilized. (S)

RE 93 - REAL ESTATE PRACTICES

3 Units

Prerequisite: RE 91 or equivalent*
3 hours lecture weekly.

Techniques of operating a real estate business with emphasis on the daily activities of brokers and salesmen; emphasis on securing and qualifying prospects, obtaining listings, and legal factors in the real estate transaction. (S)

RE 94A - REAL ESTATE APPRAISAL I

3 Units

Prerequisite: RE 91 or equivalent*
3 hours lecture weekly.

A first course in real estate appraisal confined largely to residential property with an introduction to investment property valuation; methods and techniques for determining value for loan and insurance purposes; case study situations and actual field work. (F)

RE 94B - REAL ESTATE APPRAISAL II

3 Units

Prerequisite: 94A
3 hours lecture weekly

Development of skill and judgment in the selection and use of all methods and mechanics of the income approach to the valuation of income-producing properties: apartments, commercial, industrial, and special use properties; land. Acquisition of ability to analyze major types of real estate investments and rate their feasibility.

RE 95 - REAL ESTATE FINANCE

3 Units

Prerequisite: RE 91 or equivalent*
3 hours lecture weekly.

Practical study and analysis of money markets, interest rates, and real estate financing, with actual case illustrations demonstrating lending policies, problems and rules involved in financing real property, including residential, multi-family, commercial, and special purpose properties. (S)

RE 96 - REAL ESTATE ECONOMICS

3 Units

Prerequisite: RE 91 or equivalent*

3 hours lecture weekly.

Economic trends in real estate and land use; dynamic factors which create values in real estate; background for more specialized courses in real estate operation and techniques. (F)

*Equivalence to RE 91 can be possession of a California Real Estate Sales License or ability to take the broker's examination.

recreation

Faculty: George Ragsdale

The impact of leisure on our society has opened new areas for the prospective recreation leader. Career opportunities exist in numerous areas with limited opportunities for those with Associate in Arts Degrees. The major program in recreation is designed for students who plan to follow professional careers as program leaders, directors, supervisors or administrators in public or private recreation agencies.

Of major emphasis to students planning to transfer to four year schools is the report submitted to the California Society of Parks and Recreation Educators at the March, 1972 meeting in San Diego. It was recommended that six courses be taught in the Community Colleges or lower division level. These courses include Rec 1, Rec 3, Rec 4 and Rec 5. Other courses offered at Moorpark College apply towards an Associate in Arts Degree in Recreation, but might not transfer to four year schools other than elective units.

RECOMMENDED GENERAL EDUCATION COURSES

PE 90	Intro to PE
PE 80-87	Professional Activities
PE 37	Social, Folk, Square Dance
HS 5	First Aid
Soc 1	Intro to Sociology
Psych 3	Personal & Social Adjustment
Speech 2	Elements of Public Speaking
or	
Speech 1	Intro to Speech
LH 25A/B	Turfgrass Management

courses in recreation

*Rec 1 - INTRODUCTION TO COMMUNITY RECREATION

3 Units

Prerequisites: None. Concurrent enrollment in Rec 3 recommended for majors and minors

3 hours lecture weekly

The scope and significance of community recreation. Study of the agencies and institutions that provide leisure opportunities for the community. Emphasis on inter-relationship of institutions and agencies that serve the community recreation needs. Observation and laboratory work is required. It is recommended that recreation majors also enroll in Recreation Leadership, Rec 3, which will act as the laboratory assignment.

Accepted for credit, UC (all branches)

***Rec 2 - PROGRAM PLANNING IN RECREATION**

3 Units

Prerequisites: Consent of instructor and/or completion of
Rec 1 or enrolled in Recreation or Physical
Education major/minor program
1 hour lecture, 6 hours laboratory weekly

Exploration of the role of the recreation professional with emphasis on principles of program planning. Field work required, consisting of practical experience in program planning and evaluation of on-campus recreational activities. Accepted for credit, UC (all branches)

***Rec 3 - RECREATION LEADERSHIP**

3 Units

Prerequisites: Consent of instructor and/or enrolled in Rec 1 or in Recreation
or PE major/minor program
1 hour lecture, 6 hours laboratory weekly

Exploration of the role of the recreation professional with emphasis on leadership techniques and group dynamics. Field work consisting of practical experience in program planning, scheduling, and evaluation of on-campus recreational activities will be required. Accepted for credit, UC (all branches)

***Rec 4 - SOCIAL RECREATION**

3 Units

Prerequisites: Consent of instructor or enrollment in Recreation
major/minor program
2 hours lecture, 3 hours laboratory weekly

Methods and materials for the planning, organization, and conducting of social activities for group social situations. Emphasis on the mechanics of planning, techniques of presentation, and a repertoire of activities for presenting social recreation activities. Activities will be discussed, participated in, and/or demonstrated. Laboratory work in recreation required. It is recommended that students also enroll in Rec 3, Recreation Leadership as their lab assignment. Equivalent to Rec 201, CSUN
Accepted for credit, UC (all branches)

***Rec 5 - OUTDOOR RECREATION**

3 Units

Prerequisites: None
2 hours lecture, 3 hours laboratory weekly.

A course in outdoor recreation designed for recreation majors and minors as well as other students interested in the outdoors. The class will cover four major areas: 1) A unit on soils, grasses, trees and shrubs, 2) a unit on ecological units and habitat studies; 3) a unit on outdoor skills leading toward an appreciation and practical use of the outdoors; and 4) leadership techniques in outdoor recreation settings and activities. Field trips including actual hikes and a campout will be required.

Accepted for credit, UC (all branches)

Rec 6 - THERAPEUTIC RECREATION

3 Units

Prerequisites:
1 hour lecture, 6 hours laboratory weekly

Expansion of role of the recreation professional with emphasis on program planning for the ill and handicapped. Field work required consisting of experiences in planning, conducting and evaluating programs for the ill and handicapped. Baccalaureate Level

Rec 8A/B - FIELD EXPERIENCES IN COMMUNITY RECREATION 3-3 Units
Prerequisites: Permission of instructor and/or completion of Rec 1 and/or Rec 3
1 hour lecture, 6 hours laboratory weekly

A practical experience course in which students are placed in two recreation leadership capacities per semester. Students will gain experience by working with: a public agency, a private agency, a therapeutic agency, and a fourth agency to be agreed on by the student and the instructor when a student takes both 8A and 8B. (8A-F; 8B-S)
Accepted for credit, CSUN

Rec 10 - RECREATIONAL BOATING 2 Units
Prerequisites: None
2 hours lecture weekly

A course in boating recreation and safety for boaters and for those who will be employed in the recreation area. The course includes navigation, the reading of markers and buoys, proper techniques under way and at anchor, rules of the road, and emergency measures. Field trips are included to an ocean and lake marina.

Rec 22A/B - DIRECTED STUDIES IN RECREATION 1-3 Units
Prerequisites: Consent of instructor and enrolled in Recreation major/minor program
1-3 hours weekly.

Designed for students who are interested in furthering their knowledge and experience of Recreation Leadership on an independent study basis. Assigned problems will involve library, laboratory and field work. Maximum of 6 units.
Accepted for credit, CSUN

*Maximum credit of one course at UC.

For information regarding Work Experience credit in the Recreation program, refer to Page 224 in this catalog.

recreation vehicle

The recreation vehicle industry is widely recognized as one of the fastest growing areas of new jobs in the United States today. Moorpark College, recognizing this emerging need, is offering a new program designed to train for occupational skills in the varied field of recreation vehicles.

courses in recreation vehicle

RV 1 - INTRODUCTION TO RECREATION VEHICLES 3 Units
Prerequisites: None
3 hours lecture weekly

A survey of the Recreation Vehicle industry. History and growth, manufacturing, maintenance and sales, private and public campground operations. Occupational opportunities in the industry.

RV 2 - MAINTENANCE FUNDAMENTALS

3 Units

Prerequisites: None
2 hours lecture, 3 hours laboratory weekly

This course is designed to develop skills and techniques for the operation and maintenance, and the repair and refinishing of the exterior and interior of recreational vehicles. This course will also cover the proper lubricants and lubricating procedures as applied to the recreational vehicle along with the proper use and installation of hitches and tow bars.

RV 3 - ELECTRICAL SYSTEMS

3 Units

Prerequisites: None
2 hours lecture, 3 hours laboratory weekly

Presents the basic operation, maintenance and repair of electrical systems of recreational vehicles including lighting, motor and 12V to 11V conversion systems.

RV 4 - SMALL ENGINE REPAIRS

3 Units

Prerequisites: None
2 hours lecture, 3 hours laboratory weekly

The theory and operating principles of small two-cycle and four-cycle engines. Practical work in testing, repairing, and operating small engines such as motorcycles, outboard motors and power lawn mowers.

social welfare

Faculty: Kenneth Buckner

Social workers are concerned with many types of social problems and needs. Among these are: physical, mental, and emotional handicaps; poverty; unemployment; broken homes; family maladjustment; anti-social behavior; limited recreational opportunities; and inadequate housing. A great variety of public and private agencies have social work programs, including public assistance programs, family and child welfare services, social services, for the crippled, disabled, and ill, and programs for the prevention of juvenile delinquency. Some specialized fields include school social work, medical social work, psychiatric social work, rehabilitation social work, group social work, and community organization work.

REQUIRED COURSES IN THE MAJOR

Fresno State College

Soc 1 Intro to Sociology
Soc 2 Social Problems

University of California, Los Angeles

Soc 1 Intro to Sociology
Soc 2 Social Problems
Math 15 Introductory Statistics
For Lan Foreign Language

Sociologists study the many groups and institutions which man forms—families, tribes, communities, nations, and states. They study the behavior and interaction of groups, trace their origin and growth, and analyze the influence of group activities on individual members, individual members' influence on groups and on other individuals. Sociologists may study individuals, families, or communities in an attempt to discover the causes of social problems such as crime, juvenile delinquency, alcoholism, poverty, and dependency. About three-fourths of the sociologists—people in research and administrative positions, as well as teachers—work in colleges and universities. About one-tenth are in federal, state, local, or international government agencies; the rest work in private industry or for welfare or other non-profit organizations or are self-employed.

REQUIRED COURSES IN THE MAJOR

California State University, Northridge

Soc 1 Intro to Sociology

Suggested Electives

Psych 1A Intro to Psychology
 Anth 2 Cultural Anthropology
 Econ 1A Principles of Economics
 Soc 2 Social Problems
 Soc 3 Social Analysis
 Math 15 Introductory Statistics

University of California, Santa Barbara

Soc 1 Intro to Sociology
 Math 15 Introductory Statistics
 Psych 1A Intro to Psychology

Suggested Electives

Anth 2 Cultural Anthropology
 Econ 1A/B Principles of Economics
 Hist 1A/B Intro to Western Civ.

courses in sociology

Soc 1 - INTRODUCTION TO SOCIOLOGY

3 Units

Prerequisite: Satisfactory score on Placement Test.
 3 hours lecture weekly.

The structure of society, and of human behavior in the context of a social system; basic concepts and terms used in sociological communication and research; effects of groups on individuals, groups on groups, and individuals on groups; ranges of prediction of behavior, some world-wide problems related to population and industrialization. (F,S)

Equivalent to Soc 150, CSUN
 Accepted for credit, UC (all branches)

Soc 2 - SOCIAL PROBLEMS

3 Units

Prerequisite: Soc 1 or permission of instructor
 3 hours lecture weekly.

Sociological theory regarding deviant behavior, particularly in the U.S.; major social problems, related factors, and current and proposed policies for solution. (F,S)

Equivalent to Soc 200, CSUN
 Accepted for credit, UC (all branches)

Soc 3 - SOCIOLOGICAL ANALYSIS

3 Units

Prerequisites: Soc 1
3 hours lecture weekly

Application of basic sociological concepts and methods for studying institutions and problems of contemporary American Society.
Equivalent to Soc 202, CSUN

Soc 4 - MARRIAGE AND THE FAMILY

3 Units

Prerequisite: Satisfactory score on Placement Test.
3 hours lecture weekly.

A study of the institution of marriage as a significant social unit throughout the world. Sexuality, dating, mate-selection, courtship, engagement, marriage, marital conflicts, (sources and resolution of) and parenthood are analyzed functionally and transculturally. (F,S)
Accepted for credit, UC (all branches)
Accepted for credit CSUN

Soc 5 - SOCIAL PSYCHOLOGY

3 Units

Prerequisites: Psych 1A or Soc 1
3 hours lecture weekly

A study of human social relationships. Topics of study include personal interaction, group interaction, structure and leadership, role and status, fads and fashions, attitude formation and change, communication and propaganda, nature of prejudice and social change. Stress is placed upon methods of easing group tensions and solving current problems. (Co-number Psych 5)

Soc 6 - MEXICAN-AMERICAN IN CONTEMPORARY SOCIETY

3 Units

Prerequisite: Satisfactory score on Placement Test or
consent of instructor
3 hours lecture weekly

An analysis of the socio-economic and political problems confronting the Mexican-American with emphasis on proposed solutions. Particular focus will be placed on the effects the social institutions have had on the Mexican-American community. Special emphasis will be placed on the school system. (This course will count toward Social Science or general education credit). (F) (Co-numbered MAS 1)

Accepted for credit, UC (all branches)

Soc 7 - FIELD WORK IN BARRIO STUDIES

3 Units

Prerequisites: Completion of Soc 6 or consent of instructor
1 hour lecture, 6 hours laboratory weekly

Field study observation of selected barrios, institutions, and agencies to be conducted under supervision and after preparatory instruction to acquaint students with the barrio. (Co-numbered MAS 7)
Accepted for credit, UC (all branches)

Soc 8 - MINORITY GROUP RELATIONS

3 Units

Prerequisites: Satisfactory score on Placement Test
3 hours lecture weekly.

Application of Sociological theory to the social processes which affect racial, ethnic, and sexual minorities in the United States. An analysis of the relationship between the functions of the institutions of the society and the problems of the minorities.

Accepted for credit, CSUN

Soc 22A/B - DIRECTED STUDIES IN SOCIOLOGY

1-3/1-3 Units

Prerequisites: A course in the specific field and the consent of the instructor and Division Chairman.

1-3 hours tutorial weekly.

Designed for selected students who are interested in furthering their knowledge of sociology on an independent study basis. Assigned problems will involve library, laboratory, and field work. Maximum of 6 units.
Maximum of 3 units accepted, CSUN



Faculty: Beverly Pearson, Amado Reynoso

spanish

With the growing interdependence of nations, persons with facility in foreign languages are needed more than ever. Specialists work in such areas as anthropology, economics, political science, literature, and sociology. Still the principal area of employment is in teaching on the elementary, secondary and college levels. Other careers may be found in interpreting, translating, research, diplomacy and other government work, libraries, and the publishing business.

REQUIRED COURSES IN THE MAJOR

California State University, Northridge

Spn 1A/B Elementary Spanish
Spn 2A/B Intermediate Spanish

University of California, Santa Barbara

Spn 1A/B Elementary Spanish
Spn 2A/B Intermediate Spanish

courses in spanish

Spn 1A/B - ELEMENTARY SPANISH

4-4 Units

Prerequisite: For Spn 1A, consent of counselor; for Spn 1B, Spn 1A or 2 years of high school Spanish with grades of C or better.
5 hours lecture, 1 hour laboratory weekly.

Intensive study of the Spanish Language and culture; special emphasis will be given to the skills and knowledge necessary for speaking and writing Spanish and the unique nature of the people and their history; the language laboratory will be used extensively in the class and students will be expected to arrange an additional hour of language lab time each week. (F,S)
Equivalent to Span 101, Span 102, CSUN
Accepted for credit, UC (all branches)

Spn 2A/B - INTERMEDIATE SPANISH

4-4 Units

Prerequisite: For Spn 2A, Spn 1B or three years of high school Spanish with grades of C or better; for Spn 2B, Spn 2A or 4 years of high school Spanish.

Further study of spoken and written Spanish and of Spanish culture; development of ability to read with greater ease by study and discussion in Spanish of representative literary works; continued emphasis on oral and written expression. All students will be expected to spend an additional hour per week of study in the language laboratory. (2A-F, 2B-S)
Equivalent to Span 201 and 202, CSUN
Accepted for credit, UC (all branches)

Spn 3A/B - SPANISH FOR THE SPANISH SPEAKING**4-4 Units**

Prerequisite: A speaking knowledge of the Spanish language.
4 hours lecture, 1 hour laboratory weekly

The methodical presentation of the basic communication skills of Spanish for students who are from Spanish speaking backgrounds. Emphasizing vocabulary building and conversation, both semesters increase proficiency in understanding, speaking, reading and writing Spanish. Special attention is focused on correct grammar and written communication for the Mexican-American. Equivalent to Spn 1A/B.(3A-F, 3B-S) (Co-number MAS 3A/B)
Equivalent to Mex-Am. 101 and Mex-Am 102, CSUN
Accepted for credit, UC (all branches)

Spn 4 - HISPANIC CULTURE & CIVILIZATION**3 Units**

Prerequisites: One year college Spanish or reading ability in Spanish
3 hours lecture weekly

Reading and discussion in Spanish of the civilization and culture of the Spanish speaking countries, emphasizing one or two countries each semester. (Co-Number Engl 28)
Baccalaureate Level

Spn 22A/B - DIRECTED STUDIES IN SPANISH**1-3/1-3 Units**

Prerequisite: A course in the specific field and consent of instructor
and Division Chairman
1-3 hours tutorial weekly

Designed for selected students who are interested in furthering their knowledge of Spanish on an independent study basis. Assigned problems will involve library and field work. Maximum of 6 units. (F,S)

Spn 31A - BEGINNING CONVERSATIONAL SPANISH**3 Units**

Prerequisites: None
3 hours lecture weekly

An introductory course for non-native speakers of Spanish, including elementary grammar and principles of usage. Designed for students who wish to understand and use Spanish in practical situations. Preliminary course for transfer students with no language background at all. (F)

Spn 31B - INTERMEDIATE CONVERSATIONAL SPANISH**3 Units**

Prerequisite: Spn 31A or consent of instructor
3 hours lecture weekly

An intermediate course for non-native speakers of Spanish, including grammar and principles of usage. Designed for students who have some basic conversational Spanish, but who wish to continue work in this area. (S)

Spn 31C - ADVANCED CONVERSATIONAL SPANISH**3 Units**

Prerequisite: Spn 31B or consent of instructor
3 hours lecture weekly

This course emphasizes correct oral communication in Spanish. It is especially geared for the student with a Spanish speaking background. The music, art, literature and architecture of Mexico and Spanish America will serve as the main topics of oral presentation and discussion. (F)

Spn 32A/B/C - CONVERSATIONAL SPANISH FOR PUBLIC EMPLOYEES

1-1-1 Unit

Prerequisites: None
3 hours lecture (6 weeks for 1 unit)

Course for non-native speakers of Spanish, designed especially for practical situations of civil employees such as those in law enforcement, welfare, probation, etc.

(See English 1 offerings for courses covering Spanish literature in translation.)

speech

Faculty: Sidney Adler, C. Tod Fortner, Carole Ginet, Roland Glover, Robert Reynolds, Richard Strong

Speech, or rhetoric as it was once called, is one of the oldest and most revered of the liberal arts. In addition to studying the history of oration and debate from Pericles and Cicero to the present, students now enter such specialized fields as speech therapy (working with mentally retarded, deaf and hard of hearing, and psychologically disturbed), child welfare, psychology, and counseling.

REQUIRED COURSES IN THE MAJOR

California State University, Northridge

Speech 1 Intro to Speech
Speech 2 Public Speaking
Speech 5 Oral Interpretation
(Speech 5 not required for Speech Correction major)

University of California, Santa Barbara

Speech 1 Intro to Speech
(General Speech Major)
Broad 2 Intro to Radio-TV Broad
(Rhetoric & Public Address Major)
Speech 5 Oral Interpretation
(Speech & Drama Major)
For Lan Foreign Language
(3 semesters or 5 quarters)

General Speech Major

ThA 24 Intro to the Theatre
Hist 7A/7B Soc/Pol History of U.S.
Hist 9A/9B History of the Americas
Speech and Hearing Major
Psych 3 Personal & Social Adjust.
Rhetoric and Public Address Major
Econ 1A Principles of Economics
Hist 1A/1B Intro to Western Civ.
or
Hist 7A/7B Soc/Pol History of U.S.
Combined Speech and Dramatic Art
ThA 2A/2B Fundamentals of Acting
ThA 21A Theatre Production
ThA 24 Intro to the Theatre
Hist 1A/1B Intro to Western Civ.



courses in speech

Speech 1 - INTRODUCTION TO SPEECH

3 Units

Prerequisite: Eligibility for Engl 1
3 hours lecture weekly

Training and practice in the basic principles of effective oral communication through participation in public speaking, group discussion, and oral reading; emphasis on developing constructive attitudes, organized thinking, proper use of voice and body, and discriminative listening.

Equivalent to Speech 155, CSUN

Accepted for credit, UC (all branches)

Speech 2 - ELEMENTS OF PUBLIC SPEAKING

3 Units

Prerequisites: Speech 1 or consent of instructor.
3 hours lecture weekly.

Preparation and formal delivery of various types of speeches, particularly those types requiring persuasive rhetoric; special attention to content and organization, audience motivation, and evaluation; participation in group discussion with practice in parliamentary procedure. Required of speech majors.

Equivalent to Speech 220, CSUN

Accepted for credit, UC (all branches)

Speech 3 - VOICE AND DICTION

3 Units

Prerequisites: None
3 hours lecture weekly.

Individual speech improvement instruction and practice in correct breathing, voice control and diction. The study of correct pronunciation, enunciation and voice production, including the study of dialects, foreign and regional. This course is designed for students in drama, forensics, broadcasting or education. (Co-number ThA 3, Broad 8)

Equivalent to Drama 106, CSUN

Speech 5 - ELEMENTARY ORAL INTERPRETATION

3 Units

Prerequisite: Speech 1 or consent of instructor.
3 hours lecture weekly.

Principles and techniques of oral reading of prose and poetry with understanding and appreciation; evaluation of the literature selected for reading.

Equivalent to Speech 104, CSUN

Accepted for credit, UC (all branches)

Speech 7 - ARGUMENTATION

3 Units

Prerequisites: None
3 hours lecture weekly

Principles of rhetorical argument; using evidence, detecting fallacies in argument, preparing briefs, and delivering persuasive arguments. Extensive research is expected for effective formulation and critical analysis of persuasive discourse.

Equivalent to Speech 225, CSUN

Speech 10A/B/C/D - FORENSICS**1-1-1 Units**

Prerequisites: None

1 hour lecture, 3 hours laboratory weekly

A presentation of the principles and practices of argumentation and debate, with emphasis upon research into contemporary social problems and the analysis of significant issues as based upon organized reasoning, evidence and logic. Practice and criticism of competitive speeches will be conducted before college groups. Students are expected to participate in interscholastic debate and speech tournaments which take place during the week & weekends throughout the college year.

Equivalent to Speech 198, CSUN

Speech 16 - READERS THEATRE**3 Units**

Prerequisites: Eligibility for Speech 1

3 hours lecture weekly

The concepts and practices of oral interpretation of literature. Supervised activities in performing reader theatre before community and college audiences. (Co-number ThA 16)

theatre arts

Faculty: C. Tod Fortner, Roger Meyer,
Robert Reynolds, Department Head

"All the world's a stage, and all the men and women merely players." A good play holds the mirror up to life, and actors are the "brief chroniclers" of our time. But the play also requires a host of supporting personnel, including directors, writers, costume designers, sound and light technicians, scene and theatre designers.

REQUIRED COURSE IN THE MAJOR**California State University, Northridge**

ThA 2A Fundamentals of Acting

ThA 20A/20B Theatre Production

University of California

ThA 1 Intro to the Theatre

ThA 2A/2B Fundamentals of Acting

ThA 20A/20B Theatre Production

Hist 1A/1B Intro to Western Civ.

Art 2 Art Appreciation

Music 8 Music Appreciation

Phil 1A Intro to Philosophy

PE 36 Modern Dance

Psych 3 Personal & Social Adjust.

Anth 2 Cultural Anthropology

For Lan Foreign Language

ThA 3 Voice and Diction

courses in theatre arts**ThA 1 - INTRODUCTION TO THE THEATRE****3 Units**

Prerequisite: Satisfactory score on Placement Test

3 hours lecture weekly

Introduction to the theatre as an art form; appreciation of the theatre, past and present. What the theatre is all about? How to enjoy it?

Equivalent to Drama 150, CSUN

Accepted for credit, UC (all branches)

ThA 2A/B - FUNDAMENTALS OF ACTING**3½-3¼ Units**

Prerequisites: None

2 hours lecture, 3 hours rehearsal, 1½ hours laboratory weekly

Introduction to acting techniques and development of characterization; exercises in pantomime, improvisation, movement, voice, and rhythm; practical experience in acting on stage. Laboratory activities fulfill P.E. requirement toward AA degree.

Equivalent to Drama 105, Drama 205, CSUN

Accepted for credit, UC (all branches)

ThA 3 - VOICE AND DICTION**3 Units**

Prerequisites: None

3 hours lecture weekly

Individual speech improvement instruction and practice in correct breathing, voice control and diction. The study of correct pronunciation, enunciation and voice production, including the study of dialects, foreign and regional. This course is designed for students in drama, forensics, broadcasting or education. (Co-number Speech 3, Broad 8)

Equivalent to Drama 106, CSUN

ThA 9 - ACTING FOR FILM AND TV**3 Units**

Prerequisites: ThA 2A or equivalent or permission of instructor

2 hours lecture, 4 hours laboratory weekly

Learning the techniques required in acting before the camera. Includes terminology, blocking, movement, rapid line learning, etc., as it pertains to film and TV, and as it varies from stagework; microphone techniques and opportunities to work in student-directed films and television shows. (Co-number Broad 9)

ThA 10A/B/C/D - REHEARSAL AND PERFORMANCE**2-2-2-2 Units**

Prerequisite: Consent of instructor

6 hours rehearsal weekly.

Supervised acting in performance of college-sponsored drama production; experience in all activities related to theatre presentations.

Equivalent to Drama 196, CSUN (Max. of 4 units)

Accepted for credit, UC (all branches) (Max. of 4 units)

ThA 11A/B - CONTEMPORARY MEXICAN-AMERICAN THEATRE**1-3 Units**

Prerequisite: Satisfactory score on Placement Test

A - 3 hours lecture weekly

B - 3 hours laboratory weekly

Through theatre and music, studying and presenting the Chicano community and movement. (Co-numbered MAS 13A/B)

Accepted for credit, CSUN

ThA 13 - TECHNICAL THEATRE – SUMMER THEATRE**3 Units**

Prerequisites: None

9 hours rehearsal weekly

The design and construction of sets and properties; in addition, the operation of lighting and sound equipment for the summer stock theatre production.

Equivalent to Drama 196, CSUN (3 units only)

ThA 14 - ACTING, SUMMER STOCK

3 Units

Prerequisites: None
9 hours rehearsal weekly

Participation as an actor in the summer stock theatre productions.
Equivalent to Drama 205, CSUN (3 units only)

ThA 15A - DIRECTING

2 Units

Prerequisites: ThA 2A and permission of instructor
6 hours rehearsal weekly

Study of the craft and art of stage direction, past and present day. Practical experience in direction of scenes by major playwrights. Coordinate activities with ThA 2A.

Accepted for credit, CSUN

ThA 15B - DIRECTING

2 Units

Prerequisites: ThA 15A
6 hours rehearsal weekly

Directing scenes and one-act plays by major playwrights. Coordinate activities with ThA 2B.

ThA 16 - READERS THEATRE

3 Units

Prerequisites: Eligibility for Speech 1
3 hours lecture weekly

The concepts and practices of oral interpretation of literature. Supervised activities in performing reader theatre before community and college audiences. (Co-number Speech 16)

ThA 20A/B - THEATRE PRODUCTION

3-3 Units

Prerequisites: None
2 hours lecture, 3 hours laboratory weekly

20A - Lectures and demonstrations in stage lighting, sound, and stage costuming, including practical laboratory experience as members of crews for department productions.

20B - Lectures and demonstrations in scenic design, make-up, and theatre management including practical laboratory experience as members of crews for department productions.

Equivalent to Drama 102, 103, 104, CSUN (maximum 6 units)

Accepted for credit, UC (all branches)

ThA 22A/B - DIRECTED STUDIES IN THEATRE

1-3 Units

Prerequisites: A course in the specific field and the consent of the instructor and Division Chairman.

1-3 hours tutorial weekly.

Designed for selected students who are interested in furthering their knowledge of the Theatre on an independent study basis. Assigned problems will involve library, laboratory, and field work. Maximum of 6 units.

Accepted for credit, CSUN

ThA 25 - PLAYWRITING**3 Units**

Prerequisites: None

3 hours lecture weekly.

Designed for the student to develop his skills in writing for the theatre with a possible opportunity of production. (Co-number Engl 25)

Accepted for credit, UC (all branches)

Accepted for credit, CSUN

urban services

Faculty: R. Boedecker, D. Dobson, F. Fierro, J. Hannon,
S. Herzog, Director; J. Hurley, C. Ramirez, E. Vance, S. Wall

Urban Services is a new program of Moorpark College offering students opportunities to enter the rapidly expanding field of public service, both at the state and local levels. Programs exist leading to employment at the end of one year (certificate program), and two years (A.A. Degree). The latter program also offers transfer to upper division programs at four-year institutions. Opportunity areas in Urban Services include employment as human services aides, or government managers. Related programs also offered by Moorpark College are the following: Administration of Justice, Correctional Administration, Probation and Welfare Services, Fire Science, Early Childhood Development, Recreation Technician, and Natural Resources. Most of these programs are described elsewhere in this catalog and may be researched individually by the student.

URBAN SERVICES PROGRAMS

1. Instructional Aide
 - A. Generalist
 - Ed 10A/B
 - Ed 7
 - Ed 48
 - Psych 4
 - B. Math Specialist
 - Math 7
 - Math 12
 - Math 15
 - Para-professional mathematics
 - Math 10
 - Math 14
 - Math 16A
 - Math 25A
 - C. Communication Skills Specialist
 - Engl 30 or 31
 - Engl 45
 - Engl 46
 - Reading 4A
2. Library Media Technician
 - LT 1
 - LT 2
 - LT 3
 - LT 4
 - LT 48
3. Urban Planning Technician
 - Geog 9
 - US 5
 - GC 26
 - ET 15
 - ET 17
4. Human Service Technician
 - Urban Studies 2
 - Urban Studies 3
 - Urban Studies 4
 - Urban Studies 43
5. Government Management
 - Urban Studies 6
 - Urban Studies 8
 - Urban Studies 9
 - Urban Studies 10
6. Related Training
 - Work Experience in Urban Studies
7. Urban Studies 50



courses in urban services

Urban 1A/B - CONTEMPORARY URBAN ISSUES

3-3 Units

Prerequisites: Enrollment in vocational program in Urban Studies or satisfactory score on Placement Test

2 hours lecture, 3 hours laboratory weekly

An interdisciplinary course focusing on the variety of current issues related to the urban setting such as: housing, education, law enforcement, racial conflict, pollution, land use and open space, urban renewal, and the government structure and finance necessary to meet the needs of people in the urban setting. Emphasis will be placed on field research in addition to lectures and library study. (3 units of the social science general education requirement under Section C and 3 units of breadth credit.)

Equivalent to U.S. 250, CSUN

Urban 2 - INTRODUCTION TO THE HUMAN SERVICES

3 Units

Prerequisites: Enrollment in vocational program in Urban Studies or consent of Institute Director

3 hours lecture weekly

An introductory course identifying and examining the multi-fold programs and activities of public and voluntary social welfare agencies and helping services. The key roles of these organizations in modern society is studied in depth. Students will give oral and/or written reports on the functions of the various agencies and services, the many facets of their operations and the effects they produce on individuals and groups who are influenced by them.

Urban 3 - HUMAN DEVELOPMENT IN THE SOCIAL ENVIRONMENT 3 Units

Prerequisites: Enrollment in vocational program in Urban Studies or consent of Institute Director

3 hours lecture weekly

An analysis of the developmental behaviors associated with each stage in human development, and the way the social environment helps or impedes this development. This course will examine examples of disruptive influence on human development and the means evolved by human service agencies to minimize these disruptive influences. Agencies and groups whose purpose is to combat various kinds of disruptive effects at different stages of human development will be visited for observation.

Urban 5 - URBAN PLANNING PRACTICES 3 Units

Prerequisite: Previous course in community planning

3 hours lecture weekly

This course is intended to introduce the student to the functions of a planning agency, to the nature and development of the general plan and to the elements needed to implement the general plan (circulation, housing, open spaces, land use, conservation, public buildings), and to the tools for general plan implementation which affect land use. Includes a review of the operation and problems of urban renewal. The course will provide a working knowledge of planning techniques for an individual intending to work at a paraprofessional level in planning, and is recommended for students intending to work in engineering, public administration, public works or utilities.

Urban 6 - INTRODUCTION TO GOVERNMENT ADMINISTRATION 3 Units

Prerequisites: None

3 hours lecture weekly

An introduction to the elements, principles, and trends in public administration; government and the administrative processes as a means of accomplishing public goals.

Urban 8 - GOVERNMENT PERSONNEL ADMINISTRATION 3 Units

Prerequisites: Urban 6 or consent of Institute Director

3 hours lecture weekly

Study of principles and practices of personnel management; the procurement, development, maintenance, and use of an effective work force.

Urban 9 - ELEMENTS OF GOVERNMENT FINANCE 3 Units

Prerequisites: None

3 hours lecture weekly

A non-technical introduction to the elements of public finance; the fiscal processes of financing public improvements in an equitable and efficient manner without loss of growth.

Urban 10 - PLANNING, PROGRAMMING, BUDGETING SYSTEMS 3 Units

Prerequisites: Urban 6 and Urban 9

3 hours lecture weekly

An explanation of a systems approach designed to accommodate the multiple functions of budgeting in public service.

Urban 22A/B - DIRECTED STUDIES IN SELECTED URBAN ISSUES 1-3 Units

Prerequisites: A course in the specific field and consent of the Institute Director

1-3 hours lecture weekly

Designed for selected students who are interested in furthering their knowledge of urban issues on an independent study basis. Assigned topics will involve library, laboratory and field study. Maximum of six units can be taken.

Urban 43 - INTERVIEWING, COUNSELING AND TUTORING 3 Units

Prerequisites: A course in vocational program in Urban Services or consent of Institute Director

3 hours lecture weekly

Introduction to the principles and practices of interviewing, counseling and tutoring. An integral part of the two-year curriculum in correctional services, designed to answer the national need of the "New Careers" on all academic levels in people-to-people services. These include counselor and group counselor aids, teacher aids, eligibility workers, social worker technician, and other pre-professional positions. (Co-number AJ 43)

Urban 44 - TECHNIQUES OF GROUP COUNSELING 3 Units

Prerequisites: A course in vocational program in Urban Services or consent of Institute Director

3 hours lecture weekly

Techniques of counseling in groups with people of a variety of ages. Group exploration and sharing of feelings about problems presented. Recognition of unique and common problems, and participation in understanding and behavior change. (Co-number AJ 44)

Urban 48 - URBAN STUDIES PRACTICUM 1-3 Units

Prerequisites: Instructor approval

6-18 hours laboratory weekly

On-the-job training without financial compensation in the urban services learning center as an instructor aid under the continuous direction and supervision of a college urban services instructor.

Urban 50 - URBAN STUDIES INSTITUTES 1-3 Units

Prerequisites: Urban Service Personnel or permission of Director

3-9 hours lecture

A short term lecture-seminar series on specialized urban issues designed for Urban Studies Personnel.

Urban 54 - HUMAN RELATIONS FOR SUPERVISORS 3 Units

Prerequisites: A course in vocational program in Urban Services or consent of Institute Director

3 hours lecture weekly

Designed to help the supervisor improve techniques of dealing with others. Emphasis on understanding human behavior, individualizing contacts with subordinates and applying management principles to interpersonal relationships. (Co-number Bus 54)

For information regarding Work Experience credit in the Urban Services program, refer to Page 224 in this catalog.

water treatment courses

WT 70 - WATER TREATMENT

3 Units

Prerequisites: Consent of instructor
3 hours lecture weekly

Water supply and treatment covering historical development of water quality control practices; water sources; public health aspects of water supply; water chemistry; water treatment arithmetic; chemical treatment; filtration; softening; operation and maintenance; valves and meters.

WT 71 - WATER HYDRAULICS

3 Units

Prerequisites: WT 70
3 hours lecture weekly

Practical water supply hydraulics with emphasis on type, location, construction, operation, testing and maintenance of wells, pumping stations, and hydropneumatic systems; location, operation and maintenance of water storage facilities and distribution systems; water flow meters and recorders and automatic equipment actuating devices and controls; detection of water losses in mains and pipeline reports; fire flow requirements and Underwriters ratings.

WT 72 - WATER QUALITY AND TREATMENT

3 Units

Prerequisites: WT 71
3 hours lecture weekly

Practical water quality control and treatment with emphasis on the public health aspects of water supply; sources of contamination; sanitary defects in ground water supplies, surface water supplies and distribution systems; water quality control methods; chemical treatment, sedimentation, filtration and softening; operation and maintenance of water treatment facilities and appurtenances; operation records and computations, and other related topics. The material covered in the intermediate courses will be helpful to those preparing for the Grade III water treatment operator certification examination given by the California Section, AWWA.

WT 73 - TECHNIQUE OF WATER BACTERIOLOGY AND WATER CHEMISTRY

3 Units

Prerequisites: WT 72
3 hours lecture weekly

Elements of water bacteriology and water chemistry as they apply to the control of water treatment processes, water conditioning and to the protection of water quality in the distribution system; laboratory demonstrations and individual participation in the techniques for the physical, chemical and bacteriological examination of water.

work experience education program

I. INTRODUCTION - WHAT IS WORK EXPERIENCE EDUCATION?

Work Experience is an education program of study designed to develop and coordinate the relationship between on-the-job activities and classroom instruction. If you are currently employed either part time or full time, you may be eligible to enroll in the Work Experience Education Program.

II. WORK AND COURSE REQUIREMENTS

A. **Vocational Work Experience** - Students enrolling in the Work Experience Program at Moorpark College must be currently involved in employment that relates in a meaningful way to their college major. In addition, students must be enrolled and currently taking courses in an acceptable vocational major listed below.

Administration of Justice	Cinematography	Graphic Communications
Agriculture	Data Processing	Home Economics
Art	Early Childhood Development	Hotel & Restaurant Mngmt.
Biological Science	Education	Library Technology
Broadcasting	Engineering Technology	Photography
Business	Environmental Technology	Recreation
	Fire Science	Urban Studies

Other students may be eligible for enrollment in the Work Experience Program if it can be demonstrated that their work activities offer realistic and meaningful learning opportunities related to their field of study.

If you have any questions about the relationship between your current job activities and occupational goal, you should check with the Coordinator of Work Experience before completing your Work Experience application.

B. **Hours worked and Unit credit** - The number of units that can be received each semester for Work Experience is based on the total number of hours worked per semester. Students may receive a maximum of 12 units of credit. Units of Work Experience credit are based on the following requirements:

1 unit	-	75 hours each semester
2 units	-	150 hours each semester
3 units	-	225 hours each semester

C. **To be eligible for Work Experience enrollment** - Students must secure permission from their employer. Employers will be asked to cooperate in the development of measurable objectives and in the evaluation of Work Experience students. This evaluation will involve a job-site visit by a member of the Work Experience Staff.

III. UNIT REQUIREMENTS

Day students must be enrolled in 9 units (not including Work Experience). Evening students must be enrolled in 6 units (not including Work Experience).

IV. GEOGRAPHICAL LIMITATIONS

In general, to be eligible for enrollment in Work Experience, a student must be employed at a job site that is within an area that can be properly supervised by the college Work Experience Staff (approximately 30 miles). In addition, employment sites must offer students realistic learning opportunities and experiences. Questions as to the job site eligibility should be directed to the Coordinator of Work Experience.

V. WORK EXPERIENCE ACTIVITIES

In addition to the number of hours worked, each student will be required to complete a variety of work related activities. If you apply for enrollment in Work Experience, you will be notified early during the semester as to your eligibility, status, and the date and time of your first required Work Experience meeting. During this first session you will be informed of all requirements of the Work Experience Program, e.g., additional forms, records, or employment and Work Experience assignments.

VI. PROCESS OF ENROLLING

1. Students must register and complete a new application each semester for Work Experience enrollment.
2. Completed applications should be taken to the registration counter and submitted with student intention to enroll in Work Experience.
3. Student should be advised that application to the Work Experience Program does not guarantee enrollment. Enrollment will occur only after applications have been reviewed and found to be correct.
4. Any other questions pertaining to the Work Experience Program should be directed to the Work Experience office.



- ADLER, SIDNEY (1968) English
B.A., M.A., City College of New York, Graduate work,
New York University; Ph.D., University of Southern
California
Experience: Instructor, New York City High Schools,
Morningside High School, Inglewood; UCSB
Extension.
- AGUILERA, CHRISTINE S. (1972) Mathematics
B.A., University of California, Irvine; M.A., University
of California, San Diego
Experience: T.A. - University of California, San
Diego
- AIKEN, KIRK (1969) Art, Department Head
B.A., University of Southern California; M.A.,
California State College, Los Angeles.
Experience: Instructor Harvard High School; Shows
at CSLA Gallery, University of California, Los
Angeles County Museum, Museum of Science and
Industry, Pasadena Design Show; One Man Show,
Municipal Art Gallery.
- AINGE, KENNETH E. (1967) Chairman, Division of
Technology
Placement Director
A.B., University of California, Santa Barbara; M.A.,
University of California, Los Angeles; Ed.D, Brigham
Young University
Experience: Department Manager, Sears, Roebuck
and Company; Sales Agent and Underwriter, Allstate
Insurance Company; Instructor and Coordinator,
Pasadena City College. (Sabbatical, Spring, 1974)
- ALGER, NORMAN (1970) Anthropology
B.S., University of Washington; M.A., University of
California, Santa Barbara
Experience: Teaching Assistant, University of
California Santa Barbara, Arizona State University;
Instructor, University of California, Santa Barbara
Extension, San Fernando Valley State College
Extension.
- ALLEN, JUDITH (1968) English
A.B., Pennsylvania State University; M.A., Sacramento
State College; M.L.S., Immaculate Heart College.
Experience: Teaching Assistant, University of
Southern California; Instructor, California State
Polytechnic College, San Luis Obispo and California
State College, Los Angeles
- ANDERSON, DONALD (1968) Agriculture
B.S., Fresno State; M.A., California Polytechnic
College, San Luis Obispo
Experience: North American Aviation, Special
Technician, Engineering Department; Instructor,
Sanger High School.
- BASSETT, ESTELLA M. (1967) College Nurse,
Health Education
R.N., Saint Mary's Hospital School of Nursing,
Rochester, New York; M.S., State University College
Brockport, New York; M.P.H., University of
California, Los Angeles
Experience: Director of Health Services, State
University College, Geneseo, New York; Associate
Professor-Health Education, State University College,
Brockport, New York; Health Administrators
Workshop, Brigham Young University, June, 1970;
Nurse Practitioner, Brigham Young University, June
1973.
- BENDAT, WILLIAM I. (1970) Counseling
B.A., University of California, Los Angeles; M.A., San
Diego State College; Graduate Study, Los Angeles
State College, San Fernando Valley State College
Experience: NDEA Year Grants, Consultant-group
Counselor, Los Angeles City Schools and Tacoma City
Schools; Instructor, Los Angeles City Schools, Pierce
College.
- BERG, EUGENE (1970) Chemistry
A.B., University of California, Los Angeles, M.S.,
California State College, Long Beach; Ph.D.,
University of California, Los Angeles.
Experience: Instructor, University High School.
- BERON, ALBERTO (1971) Mathematics
B.S., M.A., California State University, Los Angeles
Experience: Mathematics consultant, California State
Department of Education; Instructor, University of
California, Los Angeles, Pepperdine University.
- BETTINI, ARTHUR J. (1967) History
B.A., M.A., University of California, Los Angeles.
Experience: Supervising teacher, University of
California Psychology Clinic School; Instructor,
Inglewood High School; Inglewood Adult Evening
School; Ventura College.
- BIDERMAN, SHARON (1972) Secretarial
B.A., Cornell College, Iowa
Experience: Secretary, Moorpark College, Raypak,
System Development Corp., Rocketdyne.
- BISHOP, DAVID L. (1968) Life Science
B.S., Washington State University; M.A., University of
California, Santa Barbara
Experience: Teaching Assistant; Instructor, Santa
Barbara City College.
- BLACK, RICHARD L. (1968) English
B.A., M.A., University of California, Santa Barbara
Experience: Student-Teaching, Santa Barbara City
College
- BOEDECKER, ROGER W. (1967) Chairman, Division of
Social Sciences
B.A., M.A., Long Beach State; Graduate Work at
Claremont Graduate School, Eastern Oregon College,
University of California, Riverside; University of
California, Santa Barbara and Los Angeles State
College
Experience: Instructor, Westminster Intermediate
School, Huntington Beach High School, Rim of the
World High School
- BOWEN, DONALD C. (1967) Business Administration
B.S., San Diego State College; M.B.A., University of
California, Los Angeles, Additional Study at
University of Southern California, Los Angeles State
College, and California State University, Northridge.
Experience: Bank Auditor, Corporate controller.
- BRIDGEMAN, GERALD (1969) Political Science
A.B., M.A., University of California, Berkeley
Experience: Instructor, Yuba College, Kauai High
School, Hawaii, Lick-Wilmerding School, San
Francisco (Leave, 1973-74)
- BRINKMAN, GARY W. (1967) Counselor
A.A., Mt. San Antonio College; B.S., Brigham Young
University; M.A., California State Polytechnic College;
Ed.D., Brigham Young University
Experience: Instructor, King City High School,
LaHabra High School; California Polytechnic;
Administrative Assistant, Brigham Young University
- BRISBY, WILLIAM L. (1969) Biology
B.S., Colorado State University; M.S., University of
Southern California
Experience: Science Education Consultant, State of
California; Director Marine Biology Institute, Naval
Missile Center, National Science Foundation,
University of California, Santa Barbara; Research
Biologist, Naval Missile Center; Industrial Consultant
Marine Biology; Chairman, Science Department,
Filmore High School
- BROCKETT, DONALD (1970) Health Science
B.A., M.A., Fresno State College
Experience: Instructor, Camarillo High School, Rio
Mesa High School, Anaheim Union High School
District

- BUCKNER, KENNETH (1968) Sociology
B.S., M.A., University of Southern California
Experience: Instructor, Los Angeles City Schools, Burbank High School, Santa Monica City College
- BURKE, TANYA L. (1967) Business Education
B.S., M.A., Western Michigan University, Graduate work at San Fernando Valley State College and California State, Los Angeles
Experience: Instructor, Western Michigan University, Elk Grove High School
- CAMILLUCCI, LEWIS (1969) Associate Dean of Students
Counseling
B.A., M.A., San Jose State College
Experience: Chairman of Counseling, Channel Islands High School; Counselor, Oxnard High School; Instructor, Hueneme High School, Oxnard High School, NDEA Counseling and Guidance Institute, Atlanta University
- CHAPMAN, JANE M. (1968) Foreign Language
B.S., M.A., Purdue University
Experience: Instructor, Los Angeles, Glendale School Districts, Glendale College (Leave, 1973-74)
- COOL, PHYLLIS (1970) Counselor
B.A., La Verne College; M.S., NDEA Institute, San Diego State College
- COPSEY, CECIL F. M. (1968) History
B.A., University of California, Berkeley; M.A., University of California, Los Angeles
Experience: Instructor, Golden West College; Santa Monica City College
- CORBELL, MARJORIE (1970) Secretarial
A.A., Kansas City Junior College, B.S., Central Missouri State College; additional course work California State College, Los Angeles.
Experience: Instructor, Simi Unified District
- COSTER, JAN KILIAN (1972) Philosophy
B.A., Harvard University, Massachusetts; M.A., University of California, Santa Barbara
Experience: Instructor, Santa Barbara Community College
- CROWE, JUDY L. (1968) Home Economics
B.S., University of California, Los Angeles, M.S., San Fernando Valley State College
Experience: Southern California Gas Company Home Economist
- DAVIE, JOHN (1971) English
B.A., M.A., University of California, Santa Barbara.
Experience: Teaching Assistant and Associate, University of California, Santa Barbara
- DEUTSCH, DOLORES (1970) Nursery School
B.A., University of California; M.A., San Fernando Valley State College
Experience: Director, Tarzana Parent Cooperative Nursery School; Principal and Acting Director of San Fernando Valley State College Pre-School Laboratory; Instructor of Education, San Fernando Valley State College
- DICKNEIDER, WILLIAM C. (1969) Economics
B.S., M.A., University of California, Los Angeles
Experience: Peace Corps, Peru; Accounting Department, Pacific Lighting Gas Supply Co., Los Angeles; Instructor, Santa Monica City College.
- DOBSON, DALE E. (1970) Instructional Media
B.A., M.A., California State University, Los Angeles, Post Graduate Work UCLA
Experience: Free Lance Designer, Director of A-V Communications, Instructor, MDTA, Garvey School District, Walnut School District
- DODGEN, WILLIAM (1971) Art
A.B., Drury College, Missouri, M.F.A., University of Wichita, Kansas.
Experience: Illustrator, Boeing Aircraft, Washington; Instructor, Arkansas Polytechnic College, Arkansas; Moorpark Union High School, Moorpark.
- DUNHAM, PAUL (1967) Chairman, Health Science/
Physical Education
A.A., Taft Junior College; B.A., University of California, Santa Barbara; M.A., San Fernando Valley State College
Experience: Instructor, Santa Ynez High School, Camarillo High School, Thousand Oaks, High School, Ventura College
- EDDE, BYRON D. (1967) Coordinator, Engineering and
(Sabbatical, Spring, 1974) Environmental Studies
B.S., University of California at Berkeley; M.S., University of California, Los Angeles
Experience: Electronics Engineer, Pacific Missile Range, Pt. Mugu; Member of Technical Staff, Hughes Aircraft Company; Senior Engineer, Litton Systems
- EDWARDS, RICHARD (1970) English
A.A., Ventura College; A.B., University of California; M.A., Yale University
- EKBACK, HUGO (1971) English
B.A., University of California, Riverside; M.A., Chico State College, California
Experience: Teaching Assistant, Chico State College; University of Utah
- ESCOBEDO, EDWARD (1971) Counselor
A.B., University of California, San Bernardino Valley College, Ventura College, M.Ed., University of California, Santa Barbara.
Experience: Neighborhood Youth Corps, Oxnard - Field Representative.
- FECHT, GERALD R. (1969) Director of Student
Activities
A.A., Los Angeles Valley College; A.B., M.S., University of Southern California; Graduate studies at Loyola University, U.C.L.A. and U.S.C.
Experience: Instructor, L.A. City Schools and Burbank Unified School District.
- FERGUSON, JEFFREY (1972) Counselor
B.A., University of California, Santa Barbara; M.A., Stanford University
Experience: Advisory Board member and Counselor, Stanford Institute for Behavioral Counseling; Counselor - Motivation to Study, DeAnza College, Cupertino, California; Research Assistant & Consultant, College Entrance Examination Board.
- FIERRO, FRANK (1970) Mexican-American Studies
A.A., Los Angeles Valley College; B.A., CSUN
- FINK, PAUL (1970) Philosophy
B.A., Pennsylvania State University; M.A., University of Rochester, Graduate Studies UCLA & USC
Experience: Instructor, Long Beach City College
- FLEMING, JACK A. (1968) Coordinator,
Law Enforcement
B.A., Sacramento State College
Experience: Kern County Sheriff; Instructor, Bakersfield College, Orange Coast College
- FORTNER, C. TOD (1969) Drama, Speech
B.A., M.A., Fresno State College
Experience: Entertainment Specialist, U.S. Army Special Services; Instructor, Fresno City Secondary School District; Actor, Pacific Conservatory of the Performing Arts; Instructor, Butte Community College

- GARBUTT, MAX O. (1969) Mathematics
A.B., University of California, Berkeley; M.A., San Jose State College
Experience: Surveyor, State of California; Instructor, Chico State College; IBM Corporation programmer
- GAYLE, JAMES R. (1967) Associate Dean of Instruction
B.S., U.S. Naval Academy; M.S., Purdue University; Graduate Study, Reed College, University of Missouri, U.C.L.A., University of Washington, California State University, Northridge.
Experience: Naval Officer; Instructor, Bakersfield College
- GILMAN, RICHARD E. (1967) Life Science
B.S., M.S., St. Mary's College; Winona, Minnesota; Graduate study at University of Iowa, University of California at Los Angeles, M.S. University of Southern California
Experience: Research Assistant, State University of Iowa, Instructor, Burbank High School, Ventura College
- GINET, CAROLE (1968) Counseling/Speech
A.B., University of California, Berkeley; M.S., University of Southern California
Experience: Instructor, Canoga Park High School
- GLANTZ, JOSEPH (1972) Geography
B.A., University of California, Los Angeles; M.A., Cal State University, Northridge
Experience: Meteorologist, Rocketdyne, Instructor, San Fernando Valley State College
- GLOVER, ROLAND (1968) Speech
B.A., California State, Los Angeles; M.A., Mt. St. Mary's College
Experience: Instructor, West Torrance High School, Aviation High School, Los Angeles Trade Tech College, Compton College
- GONZALEZ, JOSEPH G. (1971) History
B.A., M.A., University of California, Santa Barbara
Experience: Teaching Assistant, University of California, Santa Barbara.
- GRAY, JOHN M. (1971) Photography and Graphics
Institute of Design, Chicago, Illinois
Experience: Advertising Manager, Pacific Music Supply; Art Director for "Open Places" magazine, New York City; West Coast Photographer for Intercontinental Press, New York; Photographer for Nancy Palmer Agency, New York; Three One Man Shows. Prizes: Dunachrome International Slide Competition, Zeiss Ikon Image Makers Competition; Anapolis Maryland Festival of the Arts.
- GRIFFITH, RANDOLPH W. (1967) History
B.A., University of California at Riverside; M.A., University of California at Los Angeles
Experience: Social Worker and social work supervisor, Los Angeles Bureau of Public Assistant; Vocal tutor in New York City, Ventura, Los Angeles, San Bernardino
- GUCCIARCO, PETER (1971) Economics,
Work Experience Coordinator
A.B., California Lutheran College, Thousand Oaks, California; M.A., University of Southern California, Los Angeles
Experience: Business Management, Part-time Instructor, Oxnard Union High School District
- HANFT, JOHN W. (1967) Department Head,
Language & Literature
B.A., University of California at Riverside; M.A., Chico State College; Graduate work, San Francisco State College, San Jose State College
Experience: Instructor, Orange Glen High School, Escondido; Sonora Union High School, Ventura College
- HANNON, JAMES (1971) Political Science
B.A., Wayne State University, Detroit; M.A., University of California, Los Angeles.
Experience: Coordinator, Head Start San Francisco and Modesto, California; Administrative Assistant, Head Start, San Fernando Valley State College, California; Instructor, Political Science, California Lutheran College, Thousand Oaks, California
- HARDY, MARY DIANE (1973) Physical Education
(one year appointment)
B.S., M.S., University of California, Los Angeles
Experience: Instructor, UCLA, CSUN, Santa Monica High School.
- HARRIS, VERLE D. (1968) Engineering
B.S.E., California State University, Long Beach, Registered Professional Engineer
Experience: Structural Engineer, Homes and Narver; Civil Engineer, Ventura County Department of Public Works; Civil Engineer, Department of Agriculture; Consulting Engineer
- HAYASHI, MASATO (1971) Mathematics
B.S., California State University, Los Angeles; M.A., California State College at Sonoma College.
Experience: Instructor, Sonoma College; Golden West College, Faculty Senate President, 1973-74.
- HEARON, W. RAY (1967) Dean of Students
B.A., M.A., University of California, Berkeley; Ed.D., University of California, Los Angeles; Graduate study, University of California, Los Angeles, Fresno State College, Long Beach State College
Experience: Instructor, Assistant Principal, McFarland High School, McFarland, California; Dean of Students, Shafter High School, Shafter, California; Dean of Student Activities, West High School, Bakersfield, California
- HERMAN, ROBERT M. (1968) Political Science
B.A., M.A., University of California, Santa Barbara
Experience: Research Assistant, University of California, Santa Barbara; Field Consultant for the Office of Economic Opportunity; Teaching Assistant, University of California, Irvine; Advisor, President's Commission on Law Enforcement and the Administration of Justice, Faculty Senate President, 1972-73.
- HERZOG, STEPHEN J. (1967) Humanities/Social Science
B.A., M.A., Ph.D., University of California, Los Angeles
Experience: Part-time Instructor Los Angeles City College; Santa Monica City College; Instructor, Ventura College, Moorpark College Faculty Senate President, 1967-68.
- HEYDENREICH, JOHN (1971) Counselor
B.S., University of Southern California, M.S., California State College, Los Angeles
Experience: Instructor, Pasteur Jr. High, Los Angeles, Wright Junior High, Los Angeles, Hale Junior High, Woodland Hills, California; Instructor, Counselor, Coach, Birmingham High, Van Nuys, California; Counselor El Camino Real High School, Woodland Hills, California.
- HO, DIANA (1970) English
A.A., Ventura College; B.A., M.A., San Francisco State College
Experience: Instructor, San Francisco State College
- HOBSON, ANTHONY RAY (1970) Graphic Arts
B.S., California State Polytechnic College, San Luis Obispo; M.A., California State College at Long Beach.
Experience: Graphic Artist, Logicon, Inc., San Pedro; recipient of "Who's Who Among Students in American Colleges and Universities," 1968-69.

- HOUSER, PHILIP (1969) French, English
B.A., Ursinus College, Pennsylvania; M.A.,
Pennsylvania State University
Experience: Instructor, Pennsylvania State
University; University of California, Berkeley, Rio
Vista Senior High School, Rio Vista, California;
Ventura College, Solano College, California
- HURLEY, JOHN E. (1967) Reference Librarian
B.A., M.A., San Diego State College; M.L.S.,
University of California, Los Angeles
Experience: Instructor, Grossmont High School
District
- HYAMS, ALAN (1971) English, Music
B.A., M.A., California State College, Los Angeles
Experience: Instructor, John Burroughs Jr. High;
Hale Jr. High and Taft High School, California, Los
Angeles Adult Education.
- IMBACH, MARJORIE (1971) Coordinator,
Community Services
B.A., University of California, Santa Barbara; M.A.,
University of California, Los Angeles.
Experience: Instructor, Jordan Jr. High; Burbank
High School, California.
- INGERSOLL, ORBIE D. (1967) Music
B.A., CSUN; M.A., University of California, Santa
Barbara
Experience: Instructor, Alemany High School,
Mission Hills; Adolfo Camarillo High School;
Conductor, Ventura County Student Symphony
Orchestra; Associate Conductor, Ventura County
Symphony Orchestra
- JAY, WILLIAM (1969) Counseling/Mathematics
B.A., M.Ed., University of Vermont
Experience: Counselor, Burbank High School;
Instructor, Burbank High School, Vergennes, Vt. High
School, Enosburg Falls, Vt. High School
- KEEVER, JOHN P. (1969) Physical Education
B.A., University of California, Santa Barbara; M.A.,
Chico State College
Experience: Assistant Football coach, University of
California, Santa Barbara; UCSB Coaching Camp
assistant coach; Rugby coach, assistant football coach,
Chico State College
- KLOSE, TAYLOR (1971) English
B.A., Harvard University, Massachusetts; M.A., CSUN
Experience: Instructor, Alexander Hamilton High
School, Francis Parkman Jr. High; Palos Verdes High
School, California. (Leave, Fall, 1973)
- KURTIK, RICHARD J. (1971) Chemistry
B.S., California State College; M.A., University of
California, Santa Barbara
Experience: Instructor, Torrance Unified School
District; Teaching Assistant, University of Arizona,
University of California, Santa Barbara
- LANDSTAD, JULIE (1968) English
B.A., University of Southern California; M.A.,
California State College, Long Beach
Experience: Instructor, Morningside High School,
Inglewood
- LANE, JAMES W. (1969) Law Enforcement
A.A., Valley College, Van Nuys, California; Los
Angeles City Police Captain
Experience: Instructor, Vallev College
- LLOYD, LAWRENCE G. (1967) Assistant Dean
of Instruction,
Career Education and Community Campus
B.A., M.A., University of Southern California
Experience: Instructor Burbank High School,
Instructor Moorpark College 1967-69; Coordinator
Community Services and Publications, 1969-72;
Chairman CSA 1972-73.
- LOMBARDI, ROBERT A. (1967) President
A.B., M.A., Ph.D., University of Southern California
Experience: Counselor-Instructor, Ventura College;
Dean of Students, Moorpark College
- LONG, KNOX T. (1968) Counseling/Liberal Arts
B.A., University of California, Santa Barbara; M.A.,
California State College at Los Angeles
Experience: Instructor, San Marino High School, San
Luis Obispo High School; Cuesta College, Ventura
College
- LOPEZ, ROBERT (1971) Archaeology/Anthropology
B.A., M.A., CSUN
Experience: Archaeological Aid, State of California
Parks and Recreation Department
- LOSSNER, WALTER M. (1969) Sociology
B.A., B.D., Concordia Seminary; M.S., Los Angeles
State College, Ph.D., University of Southern
California; Counseling Psychologist, Compton
Counseling Service, Lic. Marriage, Family & Child
Counselor
Experience: Instructor, Glendale College, University
of Southern California, Pastor, Lutheran Church
- LOWE, ALAN (1969) Psychology
B.A., M.A., Ph.D., University of California, Los
Angeles; Graduate work, University of California
Experience: Research Assistant, University of
California; Consultant and research assistant, Institute
for Development of Educational Activities, Los
Angeles, Extension Instructor UCSB, Counselor
Moorpark College.
- MALLORY, NORMAN C. (1972) English
B.A., M.A., Chico State College, California
Experience: Instructor, Chico State College,
University of Nevada, Reno
- MARTIN, FLOYD D. (1967) Mathematics
B.S., M.A., Arizona State University; Advanced
Graduate Study, Arizona State University; CSUN
Experience: Dean of Men's staff, Teaching Assistant,
Arizona State; Engineer, Systems Analyst, Motorola,
Inc., Faculty Senate President 1971-72.
- MASON, KATHLEEN C. (1967) Physical Education
B.A., B.F.A., University of Utah; M.E.D., University
of Maryland; Fulbright Scholar, Great Britain.
Experience: Instructor, George Washington
University, Washington, D.C., Georgetown Dance
Workshop, Washington, D.C.
- MCCULLOUGH, MODEAN (1969) Physical Education
B.S., Jamestown College, Jamestown, North Dakota;
M.S., University of North Dakota
Experience: Instructor, University of North Dakota,
Perris Valley Jr. High School, Perris, California; Valley
City State College, North Dakota; Simi Valley High
School (Leave, 1973-74)
- MEDLEY, DON B. (1968) Data Processing
B.V.E., M.A., California State University, Los Angeles
Experience: Senior Management Systems Designer;
Xerox Data Systems, Senior Computing Analyst,
Rocketdyne; Manager, Data Processing Operations,
Telecomputing; Programmer, Hughes Aircraft
- MEHR, SHELDON (1970) Music
Northwestern University; B.A., University of
California, Los Angeles, M.A., California State College,
Graduate Work, USC and CSUN
Experience: Instructor, Granada Hills High School
and other L.A. City Schools.
- MENDOZA, GILBERT R. (1973) Physical Education
B.A., Fresno State College, M.A., California
Polytechnic, San Luis Obispo
Experience: Garden Grove Unified School District,
California State University at Fullerton.

- MENZIE, JOHN C. (1967) Physics
A.B., University of California, Riverside; M.A., Brown University Graduate School, Ed.D. UCLA, Graduate studies, Claremont Graduate School, University of Wyoming, North Carolina State, University of California, Los Angeles
Experience: Instructor, San Bernardino Valley College, University of Wyoming; Fulbright Hayes Teacher Exchange, England, 1970-71, Faculty Senate President, 1969-70.
- MEYER, HAROLD F. (1969) Physics
B.S., M.A., California State College, Long Beach
Experience: Electro-Optical Engineer, Hughes Aircraft; Instructor California State College, Long Beach
- MILLER, ALFRED J. (1972) Broadcasting
A.B., University of N. Carolina; M.S., University of Illinois
Experience: Asst. Prof. University of Georgia, Columbia College of Communications, Director of Programming, Theta Cable of Los Angeles, Staff Announcer, WGKA, Atlanta.
- MILLER, LARRY O. (1971) Biology
B.A., M.A., Ph.D., University of California, Santa Barbara
Experience: Lecturer, University of California, Santa Barbara; Research Biologist, Firestone Tire and Rubber Co., Akron, Ohio.
- MILLER, ROBERT W. (1967) Chemistry, Physical Science
A.B., Temple University; M.S., University of Arizona, Graduate Study, California State University, Long Beach
Experience: Research Chemist, Shell Chemical Company, Faculty Senate President, 1968-69
- MOLNAR, CHARLES D. (1968) Department Head,
Mathematics
B.S., Harvey Mudd College; M.A., University of California, Riverside; Graduate Study, Claremont Graduate School, Stanford University CSUN
Experience: Instructor, Claremont High School, Chaffey High School.
- MOORE, JAMES, Jr. (1967) Assistant Dean of Students
Admissions & Records
B.S., M.S., University of Southern California
Experience: Division Head and Athletic Director, Yuma Union High School District, Instructor and head football coach, Ventura College, Chairman, Health Science/Physical Education Division, Athletic Director, Moorpark College.
- MOORE, LINDA (1968) Physical Education
B.A., Purdue University
Experience: Physical Education instructor, Moorpark High School, NSF Summer Institute, Purdue University, Klondike School government research project.
- MOORE, RICHARD L. (1966) Dean of Instruction
B.A., Claremont Men's College, M.B.A., University of California, Berkeley; Ph.D., Claremont Graduate School and University Center
Experience: Assistant Professor of Business, San Jose State College; Division Chairman of Business and Economics, Director of Vocational Education, San Bernardino Valley College.
- MURPHY, DAVID K. (1969) Chemistry
B.S., University of California, Berkeley; M.A., Ph.D., University of California, Santa Barbara
Experience: Teaching Assistant, Research Assistant, Associate, Summer Session Lecturer, University of California, Santa Barbara.
- NASATIR, DOROTHY E. (1972) Early Childhood
Education
B.S., Purdue University, Indiana; M.A., California State University, Northridge.
Experience: Instructor, Los Angeles City Schools; Nursery School Instructor, Child Care Centers.
- NORDQUIST, ALVYN O. (1967) Physical Education
B.A., San Diego State College; M.A., Long Beach State College
Experience: Instructor, Lynwood High School, Compton College.
- NOYES, JACK (1970) Art
B.S., M.A., University of Michigan
Experience: Instructor, New Park Avenue School, Conn. Illing Junior High School, Conn. Bakersfield College.
- OWEN, EARL B. (1967) English
B.A., University of Redlands; M.A. University of California at Los Angeles
Experience: Instructor, Hinkley Elementary School, Hinkley, California; Principal and teacher at the Bureau of Indian Affairs School, Alakanuk and Wales, Alaska; Instructor at Nome High school, Nordhoff Union High School, Ventura College. (Leave, 1973-74)
- PACHECO, DARLENE (1969) Psychology
B.A., Colorado State University; M.A., Ed.D. Colorado State University
Experience: Instructor, Adams City, Colorado, School Psychologist, Polk County Board of Education, Iowa; Instructor Ventura College.
- PAGSON, PAUL (1971) Social Science
B.A. Loyola University, Los Angeles
Experience: Instructor-lab assistant, Los Angeles County USC Medical Center.
- PARKER, DELBERT M. (1969) Physical Education
B.S., M.S., University of California, Los Angeles
Experience: Instructor, University of California, Los Angeles, United States Military Academy, West Point.
- PATTERSON, SUSAN (1972) Chemistry
B.S., University of Illinois M.A., University of California, Los Angeles
Experience: Teaching Assistant, University of California, Research Assistant, Eastman Kodak Fellowship.
- PEARSON, BEVERLY J. (1967) Spanish
B.A., University of Michigan, M.A. University of California, Berkeley, NDEA Institutes at USC and Burgos, Spain
Experience: Instructor, Mt. Diablo High School, College of Marin, Ventura College.
- PERRY, RICHARD (1970) Political Science
B.A., University of California, Santa Barbara; J.D. University of California School of Law, Berkeley; M.A., Sacramento State College
Experience: Peace Corps, Thailand, Instructor, Lassen College.
- POLLOCK, STEVEN J. (1968) Psychology
B.A., Whitman College, Washington; M.A. Claremont Graduate School, Ph.D., Claremont Graduate School
Experience: Research Assistant, Whitman College; Pitzer College and Claremont Graduate School, teaching assistant, National Institute of Mental Health, Public Health Service Research Fellowship.
- POPIEL, JON E. (1968) English
A.B., M.A., University of California, Los Angeles
Experience: Instructor, Los Angeles Valley College.

- RAGSDALE, GEORGE C. (1968) Physical Education
B.A., M.A., Fresno State College
Experience: Instructor, Camarillo High School, Rio Mesa High School.
- RAMIREZ, CARLOS BRAZIL (1971) Social Science
B.A., San Francisco State College; M.A. University of New Mexico; Ph.D. graduate student University of California, Santa Barbara
Experience: Graduate Teaching Assistant, University of New Mexico; University of California, Santa Barbara, Instructor, Pinto Education Project, Lompoc Federal Correctional Institute.
- REYNOLDS, JACK G. (1969) Department Head,
Life Science
B.A., M.A., University of California, Berkeley
Experience: Curatorial Asst., Museum of Vertebrate Zoology, University of California; Instructor, University of California, Santa Barbara, Laboratory of Infectious Diseases, Bethesda, Md., Arctic Research Laboratory.
- REYNOLDS, ROBERT E. (1967) Department Head,
(Sabbatical, Spring, 1974) Fine and Performing Arts
B.F.A., Carnegie Institute of Technology; Ph.D. University of Minnesota, Graduate study, California Institute of Radio and Television
Experience: Professional work in theatre, radio and television; Recreation Administrator, Ventura; Instructor, University of Minnesota.
- REYNOSO, AMADO (1969) Mexican-American Studies/
Spanish
B.A., San Diego State College; M.A. San Francisco State College, NDEA Institutes
Experience: Instructor, Kraemer Intermediate School Cambria, McFarland, Fullerton, Bakersfield; Consultant to California State Department of Education; Administrator, Wasco Schools Mexican-American Project.
- RILEY, DAVID (1970) Mathematics
University of Dayton, A.B., University of California; San Francisco State College; M.A., University of California.
- RODGERS, WILLIAM C. (1968) Department Head,
Business and Economics
B.A., St. Ambrose College, M.B.A., San Jose State, Graduate Study, University of Santa Clara and UCSB
Experience: Assistant Professor, San Jose State College; Faculty Senate President, 1970-71.
- ROLFF, KARLA (1972) Anthropology
B.A., M.A., University of California, Santa Barbara
Experience: Instructor, University of California Extension Santa Barbara, Hancock College, Santa Maria.
- SARDISCO, FRANK V. (1968) Art
B.A., UCLA, M.F.A., Otis Art Institute
Experience: Instructor, Woodbury College, Los Angeles; Purchase Award, Pasadena Museum; Bronze Medal Winner, Los Angeles, Eight one-man exhibitions, Instructor, Ventura College.
- SARNECKY, DOROTHY (1967) Geology
B.A., Notre Dame; M.S., Stanford University; Graduate Study, University of Southern California, New Mexico State University National Science Foundation Institutes, Rice University, Virginia Polytechnic, New Mexico State, Colorado State
Experience: Earth Science Teaching Intern Supervisor, Stanford University, Instructor, Santa Ana College, Riverside City College
- SCOTT, DELMORE E. (1969) Art
B.F.A., M.F.A., University of Southern California
Experience. Assistant Curator, Art Department, Los Angeles County Museum; Senior Lecturer, Department of Fine Arts, University of Southern California, Adult Lecture Series, Whittier Art Association, Fine Arts Patrons of Newport Harbor, Riverside Art Association, Pasadena Art Museum; Art Photographer; Lecturer, California Institute of the Arts.
- SEELY, MICHAEL K. (1967) Division Chairman,
Humanities
A.B., M.A., University of California, Santa Barbara; Graduate work at Gonzaga University and U.S.C.
Experience: Instructor at Glenbrook Intermediate School in Concord, Punahou School in Honolulu; Assoc. Dept. of English UCSB, Instructor at Ventura College; Department Head, Language & Literature, Moorpark College
- SHERIDAN, PAMELA, (1969) English
B.A., M.A., University of California, Santa Barbara
Experience: Instructor, Santa Barbara School District.
- SHINDO, KOKKI (1969) Division Chairman, Natural
Science and Mathematics
A.B., Ripon College, Wisconsin, A.B., University of California, Los Angeles, M.S., Western Washington State, M.A., University of California, Los Angeles.
Experience: Instructor, Verdugo Hills High School, Chatsworth High School, Pierce College.
- SIEGEL, HOWARD (1967) Assistant Dean of Instruction,
Summer, Evening & Special Programs
B.A., Queens College, New York; M.A., Kansas State University, Graduate Studies, University of Connecticut; Ph.D., USC, Fellow, University of Kansas
Experience: Instructor, University of Missouri; Lecturer, USC; Ventura College; Division Chairman, Humanities, Moorpark College
- SLAMA, MICHAEL M. (1966) Director of Library Services
J.D., Charles University, Prague, Czech; M.A., University of Denver; Graduate Study, Claremont Graduate School and University Center
Experience: Catalog Librarian; Order Librarian, Assistant Librarian, University of Idaho; Assistant Librarian, California State Polytechnic University, Pomona.
- SMITH, MITCHELL L. (1972) Law Enforcement
B.S., M.S., San Diego State University
Experience: Instructor Grossmont College, El Cajon, San Diego State College Extension; Patrolman, San Diego Police Department Detective
- SNYDER, CAROL L. (1972) Biology
A.B., Occidental College, Los Angeles, M.A., San Diego State College.
Experience. Instructor, Grossmont College; Assistant Curator-Ornithology Museum
- SOMMER, MAYNARD E. (1967) Administrative Assistant
B.S., Fresno State College, M.A., University of California, Davis
Experience: Instructor, Bakersfield College; Assistant to Dean of Evening Division, Bakersfield College.
- SPILLER, R. BRUCE (1970) Agriculture
B.S., Fresno State, M.A., Cal Poly, San Luis Obispo
Experience: Instructor, Rigetti High School in Santa Maria.

- STEMEN, JAMES A. (1969) Music
B.A., Goshen College; M.A., M.S.M., Southern Methodist University, Summer sessions at Oakland University and the University of Oregon.
Experience: Instructor, Osolo Junior High School, Indiana; Elkhart Community Schools, Indiana; Choral Director.
- STEPHENS, ROBERT T. (1968) Mathematics
B.S., Brigham Young University, M.S., University of California, Riverside
Experience: Instructor, University of California, Riverside.
- STRINGER, POLLY (1970) Home Economics
B.S., Oklahoma State University, M.S. CSUN
Experience: Instructor Barstow, California, Simi Schools, Trona, California.
- STRONG, RICHARD (1971) Speech/Forensics
B.A., M.A., University of Redlands
Experience: Instructor, LaMirada High School, University of Redlands, San Fernando Valley College.
- STRUMPF, MICHAEL (1967) English, Reading
B.A., M.A., University of Southern California
Experience: Counselor-coordinator in Los Angeles City Schools, Junior High, Senior High, Adult Education; English for foreign born. (Sab., 1973-74)
- STURGEON, JAMES H. (1967) Art
B.A., M.F.A., University of California, Santa Barbara, Graduate Work, UCLA.
Experience: Partner in advertising agency, Chicago, Santa Barbara; Professional motion picture and still photographer, Produced musical play, Culver City; Painter of murals in Mexico, Instructor, Ventura College, Educational film producer.
- TALLMAN, MAXINE R. (1967) Psychology
B.A., M.A., University of California at Santa Barbara, Graduate work at Drake University, University of Iowa, Iowa State University
Experience: Psychometrist for Ventura County Board of Education; School psychologist for Des Moines Public Schools and Guidance Director for the Polk County Board of Education in Des Moines; Instructor at Ventura College.
- THIONNET, FLOYD D. (1972) Financial Aid
B.S., University of Arizona, M.S., California State Polytechnic College.
- THOMSEN, JOHN E. (1969) Engineering
B.S., M.S., University of California, Los Angeles
Experience: Instructor, Cabrillo Junior College.
- TREVINO, MANUEL O. (1971) Physical Education/
Track Coach
A.B., M.A., Chico State College, California
Experience: Instructor, Kennedy High School, Buena Park, Bellflower High School, California; Cross Country Coach, Chico High School, California.
- VANCE, ELIZABETH (1971) Sociology
B.A., M.A., California State College, Long Beach
Experience: Instructor, Lynwood Unified School District, Paramount School District, California
- VENTURA, DONATO (1971) Counselor/EOP Director
B.A., University of California, Santa Barbara; M.A., Texas Tech University, Lubbock Texas
Experience: Instructor Oxnard Union High School; Pleasant Valley School, Camarillo, University of Southern California
- WAGNER, DAVID A. (1969) Department Head,
Physical Science
B.S., Ohio State University; M.A.T., University of Michigan; M.S.T., University of Missouri
Experience: Instructor, Shreve High School, Ohio; Waynesfield High School, Ohio; Shawnee High School, Ohio; Thousand Oaks High School
- WALL, SINCLAIR (1968) Reading, English
A.B., University of New Mexico; M.A., University of Chicago
Experience: Instructor Scipio Township Schools, Indiana; Corona Unified Schools, San Diego Unified School.
- WALTERS, J. ROGER (1971) Mathematics
B.A., University of California, L.A.; M.A. University of Oregon, Graduate Study, University of Utah
Experience: Instructor, University of Oregon; Boise State College, Idaho; University of Utah
- ZABOSKI, RONALD (1970) Counselor
B.S., University of California; M.A., University of Southern California
Experience: Instructor, Parkman Junior High School, Hale Junior High School; Counselor, Crenshaw High School.

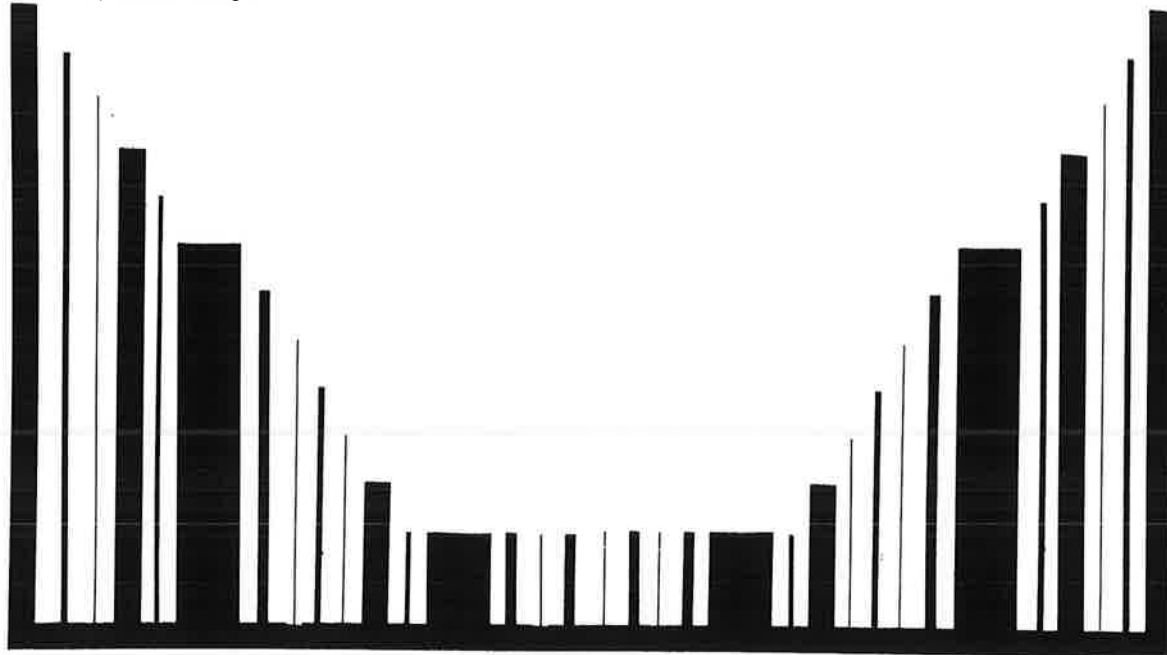

index

- Academic Policies - 21
Accreditation - 2
Adaptive Physical Education - 182
Administration - 2
Administration of Justice - 34
Admissions and Records - 7, 10
Advanced Placement - 10
Agriculture - 40
Agri-Business - 40
Airline Hostess - 137
Anatomy - 60
Animal Husbandry - 43
Anthropology - 48
Apparel Selection and Grooming - 139
Art - 50
Athletics - 176
Associate in Arts Degree - 29
Associated Students - 20
Aviation - 56
Back Packing - 180
Ballet - 182
Banking & Finance - 71
Behavioral Science - 56
Biology - 58
Biological Sciences - 57
Broadcasting - 64
Business - 67
Business Administration - 67
Business Law - 75
Business Management - 68
Career Resources Center - 7
Ceramics - 53
Certificates - 26
Chemistry - 78
Cinematography - 81
Clothing - 140
Commercial Art - 51
Communication Arts - 82
Cooking - 138
Costume Design - 137
Counseling - 6, 11
Credit by Examination Policy - 22
Credit-No Credit - 22
Dance, Modern - 182
Data Processing - 83
Dean's List - 23
Dental - 58
Dismissal - 23
Division Chairmen - 2
Doctor - 19
Dropping A Course - 22
Early Childhood Development - 87
Economics - 92
Education - 94
EOP Supportive Services - 16
Electronics - 100
Eligibility - 7
Employment Service - 17
Engineering - 96
Engineering Technology - 99
English - 104
English/Second Language - 107
Entomology - 44
Environmental Science - 111
Environmental Technology - 112
Equitation - 178
Escrow - 113
Expenses, Student - 13
Faculty - 226
Fees - 13
Financial Aid - 14
Fire Science - 114
Foreign Students - 9
Forestry - 41
French - 117
General Education Requirements - 30
General Studies - 118
Geography - 119
Geology - 122
German - 124
Governing Board - 2
Grading Policies - 21
Graduation Requirements - 29
Grants - 14
Graphic Communications - 125
Health Science - 130
Health Service - 19
History - 132
Home Economics - 136
Horticulture - 40
Hotel & Restaurant Management - 141
Housing - 20
Humanities - 145
Immunization - 19
Incomplete Grades - 21
Individual Typing Laboratory - 72
Industrial Supervision - 69
Industrial Technology - 149
Instructional Aide Program - 149
Insurance - 19
Journalism - 150
Landscape Horticulture - 41
Leadership - 153
Library Technology - 153
Loans - 15
Mathematics - 156
Medicine - 59
Mexican-American Studies - 162
Microbiology - 63
Music - 165
Natural Resources Technician - 41
Nurse - 19
Nursery School Education - 87
Out-of-District Permits - 8
Permits - Interdistrict - 8
Personal Growth - 170
Philosophy, College - 3
Philosophy - 171
Photography - 174
Physical Education - 176
Physical Science - 194
Physical Therapy - 58
Physics - 191
Physiology - 63
Placement Tests - 11
Policies, Academic - 21
Political Science - 196
Probation - 23
Programming - 84
Psychology - 198
RAP Sessions - 18
Reading - 201
Real Estate - 203
Recreation - 205
Recreation Vehicles - 207
Repeating a Course - 22
Retailing - 69
Scholarships - 15
Sculpture - 54
Social Welfare - 208
Sociology - 209
Spanish - 212
Speech - 214
State College General Education Requirements - 30
Statistics - 159
Stenography - 70
Student Activities & Organizations - 20
Student Services & Procedures - 18
Textbooks - 14
Testing, Placement - 11
Theatre Arts - 216
Transcripts - 14
Transfer Requirements - 26
Transportation - 20
Typing - 70
Urban Services - 219
Veterans - 20
Veterinary - 60
Water Treatment - 223
Wild Animal Behavior - 59
Withdrawal from College - 21
Work Experience - 23, 224
Work-Study Opportunity - 15
Zoology - 63

